

Trust, a Core Condition 1995

Malmö Art Academy

25 Years

2020

Trust, a Core Condition



LUND UNIVERSITY
Malmö Art Academy

	Foreword	5
	Timeline	11
1	Studio Visits Matts Leiderstam	22
2	Concentric Pedagogy: Towards an Ethics of the Observer Mary Kelly	37
3	Collective Pockets of Dialogue: Between Practice, Pedagogy, and Critical Thinking Maj Hasager	47
4	A Room of One's Own / A Thousand Libraries Kajsa Dahlberg	59
5	Know-How and No-How: Stopgap Notes on "Method" in Visual Art as Knowledge Production Sarat Maharaj	83
6	Suspended Stories: Rosa Barba's Strategic Narrativity Lynne Cooke	99
7	A Layman's Chalice Stephan Møller	115
8	Dishes, Diaries, and Cemeteries and selected extracts Julie Ault	128
9	The Artist as Producer in Times of Crisis Okwui Enwezor	145
10	Kasbah Walking III, Taking Photographs and Making Embroidery Hans Hamid Rasmussen	173
11	We Are Each Other's Air Övül Ö. Durmusoglu	181
12	The Anti-Apartheid Room: The World Turned Upside Down: Art and Ethics in the Rise of the "Stone Age South" Sebastião Borges, Ellinor Lager, Max Ockborn, Joana Pereira, Joakim Sandqvist and Sarat Maharaj	192

13	Letter to Sweden Jürgen Bock	205
14	Progressive Symbolic Dynamic Drawing for Gertrud Sandqvist Olav Christopher Jenssen	211
15	Stockholm, September 2020 Lars Nilsson	220
16	Malmö Art Academy at Lunds konsthall Åsa Nacking	225
17	What Does a Conceptual Artwork Look Like? Silja Rantanen	235
18	Lecture, November 25, 1996 Ola Billgren	243
19	Performance, Politics, Fiction Mark Kremer	249
20	Two Instruction Pieces by Leif Holmstrand and a Documentation Photo of a Seemingly Unrelated Piece Performed at Zarya Ccenter for Contemporary Art in Vladivostok Leif Holmstrand	269
21	Ritual for Pilgrims Karin Hald	277
22	Under Pressure Ute Meta Bauer	293
23	Thinking about Thinking Together Anders Kreuger	303
24	Notes on Teaching, Art, and Feminism Andrea Geyer	317
25	On Embodiment and Joy Michael Portnoy	329
	Contributors	339
	Faculty and Staff	348

Foreword

It is a great pleasure and honour to be able to celebrate this milestone in art education, both in Sweden and internationally—the twenty-fifth anniversary of Malmö Art Academy. This publication, *Trust, a Core Condition: Malmö Art Academy 25 Years*, serves a dual purpose: it is at once a manifestation of the artistic education and research that has and continues to happen at the Art Academy, and it is a *Festschrift* dedicated to Gertrud Sandqvist, made to honour her enormous efforts, her ingenious mind, and her crucial role in establishing and steering the Art Academy from the beginning. It also, and importantly so, celebrates the Art Academy's vision, its earned position as a strong and recognised player in the art field locally and internationally, the 540 artists who have graduated in these first twenty-five years, and the many Professors, Lecturers, Guest Teachers, and staff who contribute to and care for the Art Academy on a daily basis.

On September 1, 1995, Malmö Art Academy was inaugurated by Lund University, and its journey and development since then have proven to be strong and fruitful. The Art Academy has upheld its focus on and trust in the students' singular practices, its flexible education programme and workshops, its dedication to always being in sync with and actively engaged in the international art field, and its commitment to responding to the needs and currents of the time in which we live. A key figure in all this has been Gertrud Sandqvist, who at the end of 2020 will shift from her position as Rector and Artistic Director of the Art Academy to continue in her roles as Professor of Art Theory and the History of Ideas and as Supervisor of the Doctoral Programme. Sandqvist has been Rector since 2011, before which she was Head of Department from 1995 to 2007. She also took part in the initial process of establishing the Art Academy long before its opening, building on the foundation created by the Forum painting and graphic schools (1961–95), from which some of the first students and faculty were transferred. She has always had a strong vision and sense of making the *organism breathe*, to use her own words. In a statement she made about the challenges that creating and developing artistic education holds, Sandqvist expresses this vision for the Art Academy very precisely:

The absolute core condition for making an environment in which art can happen is trust.

If anything, this type of environment is in danger in our contemporary societies, at least for us as educators.

We must be able to trust our artist-students. We must be able to trust our artist-teachers. We must dare to allow individual curricula to have long periods when seemingly nothing is happening. We must learn how to listen to the breath of creativity.

We must facilitate this by allowing small unities, where people know each other and trust each other.

We must dare to describe rather than prescribe.

We must learn to recognise the signs that tell us when to act and when to wait.

We must be able to consider an art academy as an organism rather than a structure.¹

This publication is an initiative of the Faculty of Fine and Performing Arts, Lund University, and we who wrote this foreword took on the task of bringing it all together. As an editorial team, we wanted to gather some of the important voices and questions that have been and are part of the Art Academy's tissue, and to reflect on topics that are close to Gertrud Sandqvist's heart. Contributions arrived to us from an invited selection of notable artists, writers, and curators, all of whom have been part of the Malmö Art Academy organism over the years, whether as students, Professors, or Guest Teachers. The result is a nuanced collection of twenty-five new and republished texts, lectures, and artworks.

To begin, you will encounter texts dealing with some of the key questions in teaching that are especially relevant at the Art Academy. In his text "Studio Visits," **Matts Leiderstam**, artist, former Professor, and now External Visiting Lecturer and Researcher, explores the importance and challenges of individual studio visits. This topic is further unfolded from a feminist perspective by legendary artist and former Guest Teacher **Mary Kelly**, in her text "Concentric Pedagogy: Towards an Ethics of the Observer." In "Collective Pockets of Dialogue: Between Practice, Pedagogy, and Critical Thinking," **Maj Hasager**, artist, Senior Lecturer, and Vice Rector, asks what happens when an art academy sets out to test formats across disciplines, using the specific example of her experience setting up the MFA in Critical & Pedagogical Studies. Questions of the possibility of defining one's own space is further refined in artist and former student **Kajsa Dahlberg's** work *A Room of One's Own / A Thousand Libraries*, an artwork from 2006 that has been reworked for the context of this publication.

Next comes a series of contributions that engage with the question: What is artistic practice and artistic knowledge production? The topic is first explored in the text "Know-How and No-How: Stopgap Notes on 'Method' in Visual Art as Knowledge Production" by **Sarat Maharaj**, distinguished writer and curator, Professor in Visual Art and Knowledge Systems, and Supervisor of the Doctoral Programme at the Art Academy. This is followed by the renowned art scholar, curator, and former Guest Teacher and External Examiner **Lynne Cooke's** text "Suspended Stories: Rosa Barba's Strategic Narrativity" on the practice of the artist Rosa Barba, who earned her PhD at Malmö Art Academy and Lund University in 2018 and is now External Visiting Lecturer. In his text "A Layman's Chalice," **Stephan Møller**, artist, former student, and now Guest Teacher, discusses current attitudes towards research and concepts of knowledge, as seen from his own artistic process and practice. **Julie Ault**, lauded artist, curator, and writer, who earned her PhD at the Art Academy in 2011, contributes "Dishes, Diaries, and Cemeteries" together with a selection of interview and text extracts, offering a sensitive perspective on archiving and her engagement with the artist collective Group Material, among other of her projects.

Another strand of texts and artworks touches on various currents within the production of knowledge and subjectivities in the artistic field. The late influential critic and curator **Okwui Enwezor** looks at the intertwining of visual art, politics, and subjectivity in his text "The Artist as Producer in Times of Crisis," based on a lecture he gave at the Art Academy sixteen years ago. **Hans Hamid Rasmussen**, well-known artist and former Guest Teacher, offers a personal entry into questions of belonging and the construction of collective memories in his text "Kasbah Walking III, Taking Photographs and Making Embroidery." Questions of colonialism, power structures, and their expression and presence in and through art are nuanced by former student and now experienced curator, writer, and educator **Övül Ö. Durmusoglu** in her text "We Are Each Other's Air," on the work of Runo Lagomarsino, who also studied at the Art Academy. Following this is the presentation of the project *The Anti-Apartheid Room: The World Turned Upside Down: Art and Ethics in the Rise of the "Stone Age South"*, which took place at the Art Academy in 2017 and covers questions around migration, cosmic awakening, women in historical accounts of apartheid, and the decolonisation of knowledge production. An important aspect of this project, which consisted of multiple lectures, workshops, and more, revolved around the reconstruction of the so-called Art History Room at the University of South Africa (circa 1971), resulting in the Anti-Apartheid Room in Malmö, by artists and students **Sebastião Borges**, **Ellinor Lager**, **Max Ockborn**, **Joana Pereira**, and **Joakim Sandqvist** and here accompanied by a text by Professor **Sarat Maharaj**, who initiated the project.

In the middle section of the book, a more personal tone emerges. It begins with a letter to Gertrud Sandqvist from her long-time collaborator, the curator and educator **Jürgen Bock**, which is followed by contributions from **Olav Christopher Jenssen** and **Lars Nilsson**, both renowned artists and former External Visiting Lecturer and Professor, respectively. Jenssen contributes a drawing sequence, *Progressive Symbolic Dynamic Drawing for Gertrud Sandqvist*, and Nilsson shares his fond memories of the very first days of the Art Academy. All three offer insightful dialogues close to heart and mind. In a continuation of this tone, art historian, director of Lunds konsthall, and Sandqvist's frequent collaborator **Åsa Nacking**, in her text "Malmö Art Academy at Lunds konsthall," describes a series of exhibitions at the *konsthall* made in collaboration with the Art Academy, pointing at the importance of the presence of the school both in the artistic field and in the local community.

Following this section is a series of texts on some streams within contemporary art that have marked the period in which the Art Academy has been operating. **Silja Rantanen**, one of Finland's pioneering conceptual painters and former Guest Teacher, reflects on the importance of the conceptual approach in her text "What Does a Conceptual Artwork Look Like?" In a lecture he gave during the very first years of the Art Academy, the late renowned artist and former Guest Teacher **Ola Billgren** asks: "Why [has there been] so much work on an attempt to define a specific artistic language, and why does language become the object of exclusive, personal possession?" Independent curator, writer, critic, and former Guest Teacher **Mark Kremer**, in his text "Performance, Politics, Fiction," unfolds questions of what makes a radical practice and what the role of performance has been since the 1970s.

Next come two performative works. In *Two Instruction Pieces by Leif Holmstrand and a Documentation Photo of a Seemingly Unrelated Piece Performed at Zarya Czenter for Contemporary Art in Vladivostok* by **Leif Holmstrand**, artist, writer, musician, and former student, we are taken on a sensuous bodily journey. Meanwhile, artist, writer, and current student in the Art Academy's new MFA in Artistic Research **Karin Hald** invites us on a spiritual walk in *Ritual for Pilgrims*.

Looking at the aims and challenges of art education both locally and internationally, influential curator and former Guest Teacher **Ute Meta Bauer's** text "Under Pressure" sheds critical light on the infiltration of current market logics. **Anders Kreuger**, Head of Department and Director of the Art Academy in 2007–10 and international curator, writer, and educator, explores the experience of teaching from the perspective of a curator in his text "Thinking about Thinking Together." Extending further into questions of teaching conditions, specifically in relation to feminism, privilege, and patriarchal structures, acclaimed

artist and former Professor **Andrea Geyer** contributes with the text “Notes on Teaching, Art, and Feminism.” Finally, current Guest Teacher and performance-based artist **Michael Portnoy**, in the text “On Embodiment and Joy,” reflects on embodiment and collaboration by looking back at a specific workshop he ran with students from Malmö Art Academy and Malmö Theatre Academy in 2020.

A warm thank you goes out to all the authors and artists for your enthusiasm in contributing your writing and work and taking part in this celebration of Malmö Art Academy. A big thank you also goes to those authors and publishers who granted the Art Academy permission to republish existing texts, including Anita Billgren, who has kindly allowed us to republish Ola Billgren’s lecture from 1996, and Chika Okeke-Agulu, who generously gave permission to reprint Okwui Enwezor’s lecture from 2004.

Our gratitude also goes to Dean Anna Lyrevik and the rest of the Faculty Office for initiating this celebration and supporting the production of this publication, and to Art Academy Director Silvana Hed for her kind support. Thank you to Programme Administrator Evalena Tholin for her help in gathering the needed information, *Eller med a* for designing this beautiful publication, Jaclyn Arndt for copyediting, Jan Salomonsson for translating, and Francis Patrick Brady for proofreading.

We would also like to extend our thanks to some important key individuals who were instrumental in bringing Malmö Art Academy into existence twenty-five years ago: Johan Bengt-Påhlsson, Deputy Mayor for Culture for the City of Malmö (1991–94); Bodil Flodgren, Vice-Chancellor of Lund University (1992–2002); and Peter Honeth, Director of Lund University (1990–2006). Two more notables should be mentioned in this context: Sten Åke Nilsson, Professor Emeritus of Art History at Lund University, and, last but not least, Håkan Lundström, our former Dean and now Senior Professor of Music and Society at Malmö Academy of Music.

This book of course would not have been possible in the first place without all the staff members at Lund University who not only supported Malmö Art Academy in its very beginnings but have given their continuing support ever since.

Finally, a deep felt thank you to Gertrud Sandqvist for her significant role in establishing and forming Malmö Art Academy. We are all excited to follow its onward journey.

—Maj Hasager, Matts Leiderstam, and Marie Thams
September 2020, Malmö

1 Gertrud Sandqvist, statement for “Panel 21: Art / Education in the 21st Century,” *Front Lines, How Might We Talk about the Future?* symposium, organised by China Academy of Art and National Institute of Art, Beijing, March 2018.

Malmö Art Academy 1995–2020

This timeline highlights major developments at Malmö Art Academy together with a selection of external activities. Not included here are the reoccurring Annual Exhibitions, which present all current students' work at the Art Academy and in their studios; the BFA group exhibitions, including all third-year BFA students; and the MFA solo exhibitions, shown in the Art Academy's gallery spaces, all of which happen every year. Likewise the Art Academy's workshops, courses, lecture series, study trips, and much more have been left out of this timeline. Please see the *Malmö Art Academy Yearbooks* for more information on these activities as well as documentation of students' works.

1995

Malmö Art Academy is inaugurated by Lund University. The Art Academy opens in the building of the former Mellersta Förstads-skolan in central Malmö. Gertrud Sandqvist is named Head of Department. The establishment of the Art Academy departs from the foundation laid by the Forum painting and graphic schools (1961–95), from which some of the first students and faculty were transferred.

1995–96

External tutors are introduced into the teaching structure.

Bortom regeln, interdisciplinary symposium with Jake Chapman, Laura Cottingham, Hal Foster, Antoon Geels, Luce Irigaray, Thomas Laqueur, Irène Matthis, Cecilia Sjöholm, Klaus Theweleit, Ebba Witt-Brattström, Pål Wrangé, and Slavoj Žižek.

Malmö—Amsterdam, student exhibition at Gesellschaft für Aktuelle Kunst, Bremen, Germany, led by Eva Schmidt.

Narrative Structures, student exhibition at Forumgalleriet, Malmö, led by Jim Shaw and Marnie Weber.

1996–97

Wanås. A Dream Play, workshop resulting in an workshop and student exhibition at the Warehouse at Wanås Konst Center for Art and Learning, led by Åsa Nacking.

1997–98

Out of Site, symposium with Iwona Blazwick, Stan Douglas, Dan Graham, Renée Green, Joachim Koester, Mark Kremer, Eva Löfdahl, Alan Read, and Elin Wikström, organised by Mats Stjernstedt in collaboration with Public Art Agency Sweden.

Anlagd, large exhibition at Pildammsparken, Malmö, and a course and collaboration with students from Malmö Music Academy and Malmö Art Academy, led by Lars Ramberg.

1998–99

Deathdrive: Psychoanalysis and Art, symposium with Laura Mulvey, Peggy Phelan, Friedrich Meschede, and Denise Robinson.

Visit, a project in public space, Sölvesborg, workshop and student exhibition led by Lars Ramberg.

Encroachment (Ingrepp), workshop and student exhibition at Moderna Museet, Stockholm, led by Elisabet Skoglund and Matts Leiderstam.

Magic Carpet, workshop and student exhibition at Malmö Konstmuseum, led by Charles Esche.

Zwischenräume #4, student exhibition at Kunstverein Hannover, led by Gertrud Sandqvist, Matts Leiderstam, and Lars Nilsson.

Art Academy Students in the Park, workshop and student exhibition at Wanås Konst Sculpture Park, Knislinge, led by Lars Nilsson.

The first *Stockholm Art Fair*, workshop and student exhibition led Matts Leiderstam and Lars Nilsson; annual event until 2001.

1999–2000

Malmö Art Academy's exhibition space Peep opens in the Rooseum Center for Contemporary Art, Malmö.

Space, Time, Sound and the Visual, workshop and student exhibition at Peep, Malmö, led by Doug Ishar—a collaboration with the Composition and Church Music Department at Malmö Academy of Music.

Occupying a Hill, workshop and student exhibition at Wanås Konst Sculpture Park, Knislinge, led by Lars Nilsson.

2000–01

The student-run gallery
Båstadsgatan 4 opens in Malmö.

Cultural Studies, student exhibition at Peep, Malmö, as part of a course collaboration with the Department of Sociology at Lund University, the Royal Danish Academy of Fine Arts in Copenhagen, and the Institute of Nordic Philology at Copenhagen University.

Borders, symposium with Jimmie Durham, Mary Beth Edelson, Renée Green, Sharon Lockhart, and Collier Schorr, organised in collaboration with the Royal Danish Academy of Fine Arts, Copenhagen, and Kulturbron 2000.

Parts of the World, symposium, led by Anders Kreuger, with support from the Swedish Institute.

Nomads' Land, symposium, organised in collaboration with Protoacademy and Rooseum Center for Contemporary Art, Malmö.

Virus, workshop and student projects in public space as part of the Bo01 European Housing Expo at Västra Hamnen, Malmö, led by Matts Leiderstam, Liesbeth Bik, and Jos van der Pol.

2001–02

Malmö Art Academy establishes the PhD in Fine Arts, with Sarat Maharaj and Gertrud Sandqvist appointed as Supervisors of the Doctoral Programme.

The one-year Post-graduate programme in Critical Studies, led by Simon Sheikh, is launched.

FeminismS, symposium with Maria Lind, Tiina Rosenberg, Lilian Munk Rösing, Sara Jordenö, Sharon Hayes, Andrea Geyer, Linda Åkesson, Leonida Kovač, Women Down the Pub, Renate Lorenz, and Jessica Chalmers, organised by Gertrud Sandqvist and Simon Sheikh.

2002–03

The five-year Master of Fine Arts (MFA) programme launches.

2003–04

Art and Production of Knowledge, symposium with Lynne Cooke, Okwui Enwezor, Jens Hoffmann, Maria Lind, Juan Maidagan Sarat Maharaj, Åsa Nacking, Gertrud Sandqvist, and Dolores Zinny, held jointly with Lunds konsthall.

2004–05

Malmö Art Academy celebrates its ten-year anniversary—since 1995, 130 young artists have graduated from the Fine Arts programme.

Trespassers, symposium on queer theory with Elly Clarke, Sara Jordenö, Matts Leiderstam, and Simon Leung, organised by artist Sara Jordenö together with Rooseum Center for Contemporary Art, Malmö, and Malmö Art Academy.

2005–06

Malmö Art Academy becomes the first institution in Sweden to award three Doctor of Fine Arts degrees, to Sopowan Boonimitra, Miya Yoshida, and Matts Leiderstam.

The pilot programme Nordic Sound Art launches, which is a two-year MFA and Joint Study Programme that ran until 2012. The programme is a collaboration established within the KUNO network between the Royal Danish Academy of Fine Arts in Copenhagen, Malmö Art Academy, Oslo National Academy of the Arts, and Trondheim Academy of Fine Art.

Third-year students' site-specific exhibition at Konsthall C, Hökarängen (near Stockholm), led by Annika Eriksson and Per Hasselberg.

Ten-year anniversary exhibition at Rooseum Center for Contemporary Art, Malmö, held in the autumn. An impressive 117 of the 130 artists who graduated from the Academy during its first decade participated.

2007–08

The Bachelor of Fine Arts (BFA) programme is introduced, differentiating the Fine Arts programme into two parts: the three-year BFA and the two-year MFA.

The Master's programme in Critical Studies becomes a two-year programme, which ran until 2009.

Anders Kreuger is appointed Head of Department and Director of the Art Academy, a position he held until 2010.

A new exhibition space, KHM Gallery, opens on Ystadvägen in Malmö; it can accommodate two exhibitions simultaneously.

Cross Kick, exhibition with a selection of students, including workshops and discussion groups, at Kunstverein Hannover.

2009–10

Inter Arts Center in Malmö is established, creating an interdisciplinary facility managed jointly by the Academies of Art, Music, and Theatre.

2010–11

Silvana Hed is appointed Director of Malmö Art Academy.

Gertrud Sandqvist is appointed Rector of Malmö Art Academy.

The Art Academy launches the two-year Master of Fine Arts in Critical & Pedagogical Studies, led by Maj Hasager, which ran until 2019.

ESCAPE, educational collaboration between Hochschule der Bildende Künste Braunschweig in Germany, Maumaus in Lisbon, International Art Academy Palestine, and Malmö Art Academy. The project involves more than thirty students, who engaged in study trips, workshops, seminars, and intensive effort, resulting in an exhibition at Lunds konsthall, and at the Braunschweig academy's gallery.

2011–12

Doctoral degrees awarded to Julie Ault and Simon Sheikh.

2012–13

Doctoral degree awarded to Frans Jacobi.

Channelled, group exhibition at Lunds konsthall, based on the thinking of visionary Swedish artist Hilma af Klint (1862–1944). Featuring works by af Klint and by contemporary artists Carolus Enckell, Olav Christopher Jønssen, Joachim Koester, Christine Ödlund, Silja Rantanen, Nina Roos, and Emily Wardill. Curated by Gertrud Sandqvist.

2013–14

Doctoral degree awarded to Apolonija Šušteršič.

The recurring Annual Exhibition is held externally this year, by invitation of the Marsvinsholm Sculpture Park, near Skårby.

2014–15

Matts Eriksson is awarded a Licentiate of Fine Arts.

We will push the ship from shore and let it drift toward the darkest of oceans: Malmö Art Academy visits Malmö Art Museum, exhibition with MFA2 students at Malmö Art Museum, organised collaboration with the Art Museum, led by Emily Wardill, Joachim Koester, and Cecilia Wiedenheim.

2015–16

Malmö Art Academy celebrates its twenty-year anniversary — 300 former and current students, Professors, Lecturers, and staff take part in the celebration.

Move This!—A Symposium on Choreography and Performance in Relation to Visual Arts, half-day symposium with talks and performances by Magnus af Petersens, Luca Frei, Josefine Wikström, Mr. Rice & peanuts, and Mathias Kryger, organised by Moderna Museet, Malmö, together with Malmö Art Academy and its Critical & Pedagogical Studies students.

The Archive—Documents, Objects, and Desires, course and project exhibition with Critical & Pedagogical Studies and MFA2 students at Inter Arts Center, Malmö.

2016–17

Museet/The Museum/مختام, exhibition at Malmö Art Museum marking the conclusion of a course on “the art museum as a context,” a collaboration between the Art Academy and the Art Museum, led by Matts Leiderstam and Cecilia Widenheim.

The World Turned Upside Down: Art and Ethics in the Rise of the “Stone Age South,” course and exhibition organised in collaboration with Maumaus in Lisbon, led by Sarat Maharaj. With lectures by Franco Farinelli, Jan Apel, Ndikhumbule Ngqinambi, Paul Gilroy, Thomas Higham, Jürgen Bock, Hans Carlsson, Runo Lagomarsino, Julia Willén, Patricia Lorenzini, Jakob Jakobsen, Betty Govinden, Angela Ferreira, Arathi Sriprakash, and Manuela Ribeiro Sanches.

Dit Vindarna Bär/Whither the Winds, exhibition at Lunds konsthall, organised by the Art Academy to mark Lund University’s 350th anniversary. All exhibiting artists worked or still work at the Art Academy as Teachers, Mentors, Guest

Lecturers, and Doctoral Candidates:
Rosa Barba, Charif Benhelima,
Matthew Buckingham, Jimmie
Durham, Maj Hasager, Olav
Christopher Jenssen, Mary Kelly,
Joachim Koester, Matts Leiderstam,
Sharon Lockhart, Lars Nilsson,
João Penalva, Nina Roos, Jim Shaw,
Sophie Tottie, Emily Wardill, and
Haegue Yang. Curated by Åsa
Nacking, Emil Nilsson, and Gertrud
Sandqvist.

The Practical Past, symposium
marking the occasion of the awarding
of an honorary doctorate to Mary
Kelly by Lund University, organised
by Malmö Art Academy and Malmö
Art Museum. For the symposium,
Kelly gave a talk on being an artist
and the other speakers were artists
Maj Hasager and Bettina Camilla
Vestergaard.

2017–18

Malmö Art Academy moves into
new premises in the old tram
shed on Förargatan, in Mazetti
Culture House, and in the
Dimman neighbourhood
across Bergsgatan.

Doctoral degrees awarded to
Rosa Barba, Marion von Osten
and Andrea Ray.

Practise Practice, course for Critical
& Pedagogical Studies students
resulting in an exhibition and events
at Skånes konstförening, led by
Matts Leiderstam and Maj Hasager.

*Schools of Tomorrow: Test Run
for the School of the Future*, conference
at Haus der Kulturen der Welt,
Berlin, in which Critical & Pedagogical
Studies students participated with
a collaborative presentation.

2018–19

Doctoral degree awarded to
Alejandro Cesarco.

Flux, exhibition with MFA2 students
at Skissernas Museum—Museum
of Artistic Process and Public Art,
Lund.

2019–20

Malmö Art Academy launches the two-year Master of Fine Arts in Artistic Research (MFAAR).

An Undeniable Hit, workshop in collaboration with Malmö Theatre Academy, with live performances at Inter Arts Center, Malmö, led by Michael Portnoy.

Autumn 2020

Doctoral degree awarded to Imogen Stidworthy.

As of Malmö Art Academy's twenty-fifth anniversary, 528 artists have graduated from the Academy's programmes, 12 artists have been awarded doctoral degrees, and a vast number of artists, curators, critics, and other arts professionals have taken part in shaping the Academy, its flexible programme, and its ongoing development.

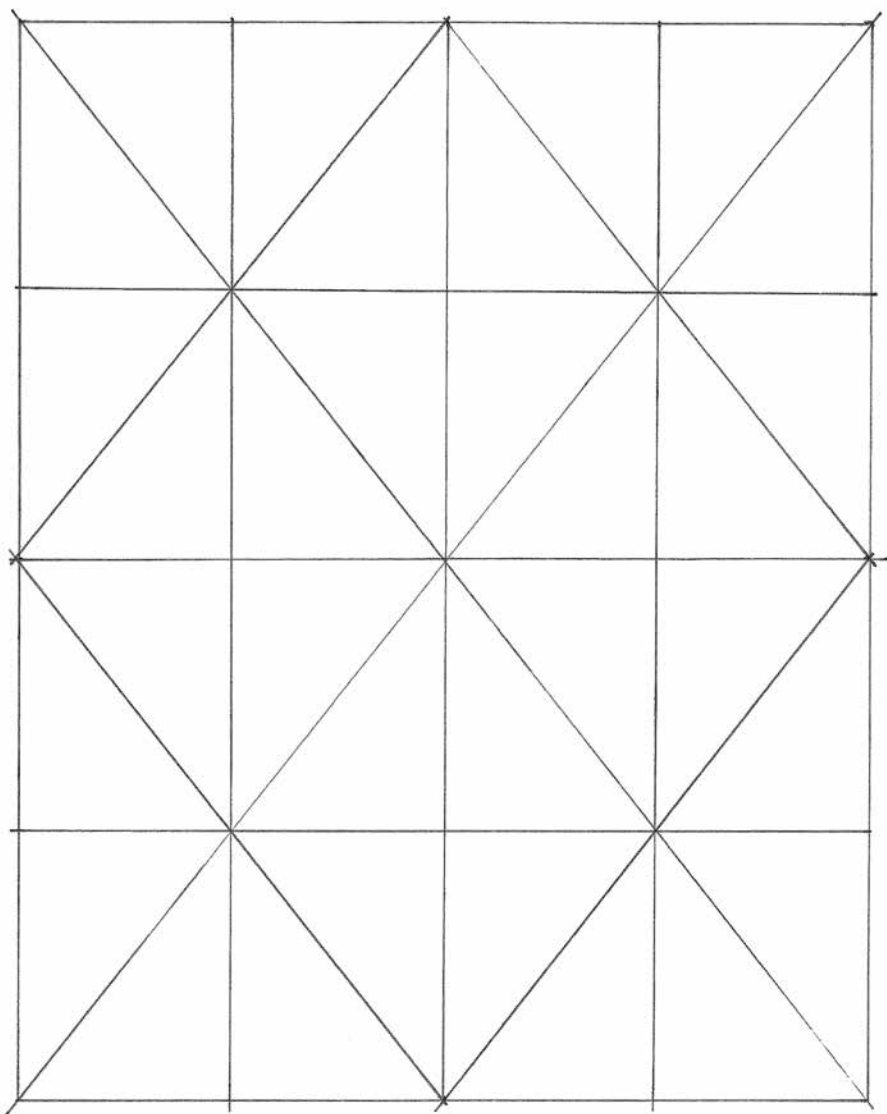

Grid drawn by Matts Leiderstam, 2018. Courtesy of the artist

Matts Leiderstam

2020

"I'm sitting in a student's studio, listening to a lament about a fire and a recently deceased father, about petrification, but also about the choice to carry on. I look at a series of paintings of little people, flags, and then, across the hallway: pine cones arranged in long rows, a natural presence, cut up and frozen, laid out in lines. At night, I dream that my entire studio is full of fried herrings. I pull open drawers, and everywhere I look: rows of neatly placed herrings."

Kent Lindfors, one of my teachers at Valand Academy in Gothenburg, wrote those words about his studio visits in the 1986 edition of the school's annual exhibition catalogue.¹ It strikes me that it's been many years since I last read Lindfors's essay, and

that I'd forgotten that he wrote about my pine cones. When I lived in Gothenburg, I sometimes picked up men in Kungsparken at night. Life was fragile, and the pine cones carried an erotic significance that I was unaware of at the time. This was when the AIDS crisis was peaking—some of my friends and past lovers died. It wasn't until a few years later, in the early 1990s, that my artworks began to address my own queer reality openly, and the AIDS epidemic began to fade away when the first effective antiretroviral treatments appeared in 1996. As I write these words, we are once again living with restrictions because of a pandemic, and I find myself wondering if this virus will have a similar impact on us—and on art.

The philosopher of art Larry Shiner has written about an interesting change in the role of the artist that occurred during a time of transition in Western civilisation: 1680–1830, when the work of artists was redefined and set apart from that of craftspeople.² A few years ago, I assigned a group of students from Malmö Art Academy a few chapters of reading from Shiner’s book. I asked them to look particularly closely at a table that lays out how these concepts changed as a result of transitioning from the old system of art production and art reception to a new one:

From the “Piece” to the “Work”: Two Systems of Art Production and Reception³

Old “Art” System	New “Fine Art” System	
Aspect	(Patronage/Commission)	(Free Market)
Production	Concrete labor	Abstract labor
Product	Piece	Work
Representation	Imitation	Creation
Reception	Use; enjoyment	Exchange; contemplation

Next, I asked the students to come up with suggestions for concepts that matched their own ideas about what they did as artists, and they produced the following:

- Production = research
- Product = project
- Representation = practice
- Reception = participation

One thing I'm sure of: if they had asked me the same question when I was an art student back in the 1980s, my answers would have been closer to the late eighteenth-century notion of what a fine artist does. Have we gone through another shift in our perceptions of what artists do? In this text, I won't seek to give definitive answers to that question; rather, I'll focus on the studio visit as a teaching method and the change that the conversations had during these visits have undergone during my own lifetime.

Before my first studio visit, I received tutoring from my first painting teachers, the artists Birgit Ståhl-Nyberg and Hendrik Nyberg, who taught me to plot a grid as follows: a rectangular surface is diagonally intersected from corner to corner, and then divided by a vertical line and a horizontal line, both running through the cross that has been produced at the centre of the surface by the diagonals. The same procedure is then repeated with each of the four rectangles that this first step produces. You continue dividing the rectangle until you've split it into sixty-four squares. This way, you'll have given yourself an aid that can help you analyse and organise your painting. This method has ties to modernist pedagogy, which was based on cubism, as well as to far older crafts traditions that originated during the Italian Renaissance. This structure has accompanied me throughout my career, and I've used it in many ways in my works.⁴

When I introduced this grid to some of my students at Malmö Art Academy, I found to my surprise that hardly any of them had seen it before. This has caused me to wonder which aspects of classic craft knowledge have been retained and which have been forgotten, as well as to ponder the impact that the new digital grid might be having on contemporary art. In connection with my own artistic research into these grids, I've carried out a series of interviews with painters from different generations, all of whom teach or have taught before, and most of them with experience at the Royal Institute of Art in Stockholm and Valand Academy in Gothenburg.⁵ The stated subject for these interviews was the grid, but we also touched on the practical realities of teaching artists. For all of us, studio visits have been a core element of our approaches and teaching—we've had countless such meetings, both as students and as teachers.

In the interviews, those of my colleagues who belong to my own generation confirmed my suspicion that we had all experienced the same manner of teaching at our preparatory art schools.⁶ This didactic approach is based in French modernism, at least as interpreted within a Scandinavian context. It involves a style of studio conversation that resembles the way Henri Matisse taught at Académie Matisse in Paris in the early twentieth century. Several Swedes and Norwegians attended the academy, and many of them

went on to play influential roles in Scandinavian art education.⁷ The method was as follows: the students worked in a communal studio, making studies of nude models. The teacher would walk from easel to easel, giving the students individual critiques. Sometimes, the whole group would walk along after him, so they could all benefit from his wisdom. This was where the “correct” manner of vision was practised, through collective form exercises that all revolved around croquis drawing. In this teaching situation, the teacher was still expected to correct the students’ work, either by demonstrating how it ought to be done in their own sketchbook or by manually altering the painting or sculpture the student was working on.

Although a less authoritarian teaching style had taken hold in the preparatory art schools by the 1980s, we were still taught to suppress anything that might be taken to be a personal expression, and instead directed to seek “signs” of what we were seeing (the model or the still life).⁸ It was only after our initiation into the basic secrets of volume, line, surface, colour, and composition that we were permitted to work on our own subjects. The most important piece of knowledge of all, as I recall, was the one about volume: how to translate the three dimensions of the body to the two dimensions of the paper. I can still recall the moment when I understood

the technique and how my vision subsequently changed.⁹ When we exchanged JPEG images of our works from those days, some of my colleagues remarked that they genuinely looked like they had been made by the same artist. They were the kinds of sketches and paintings we were expected to use in our applications to art schools.

Since the mid-nineteenth century, the predecessor of the Royal Institute of Art, the Royal Art Academy in Stockholm, has been influenced by the pedagogies of the German art academies, in which students are invited to go and work in the professors’ studios. This educational model was developed within the new system of fine art, which Shiner describes in his book, but remained rooted in the old system, where apprentices worked in the master’s workshop. That model is now, in 2020, almost completely extinct in Scandinavia, with the exception of Denmark. For a time, I took an interest in the Düsseldorf Art Academy, more specifically, in one of the school’s periods of exceptional greatness, when Johann Wilhelm Schirmer instated a landscape painting class.¹⁰ In his role as professor, he developed his own teaching method that revolved around his studio at the school. One important component of this involved the students learning by copying the professor’s nature studies, which were kept in a room adjacent to the studio. The students,

of whom a large number were from Sweden and Norway, would only, after having demonstrated their skill at copying, be trusted to head out and make their own drawings and oil sketches in nature—detailed studies of plants, trees, water, and rocks. In this way, they would acquire a mental archive of natural elements for use in future landscape compositions. Actually creating ambitious landscape paintings was reserved for the final stages of the students' time at the academy.

Several artists belonging to my teachers' generation, who I also interviewed, offered nostalgic accounts of the time they spent as students at the Royal Art Academy in the 1960s and '70s, when much of the master-apprentice teaching style of the nineteenth-century art academies remained in vogue. They studied under their professor, and rarely had access to any of the other professors at the school.¹¹ At that time, students used to work in the available studios within the professor's department—several students would often share a single room. One-to-one conversations were usually initiated by the professor, and sometimes they would be held in the presence of the rest of the group. A couple of my colleagues related public humiliations endured at the hands of either the professor or other students in the class. Some professors delivered authoritarian corrections, while others took on more fatherly roles and delivered their advice with great care. Common to all was the idea

that working hard in the studio was important—as was, I must add: being white, masculine, and heterosexual. It wasn't uncommon for the male professors to have romantic relationships with their female students. No female professor was appointed at a Swedish art academy until the 1980s.¹²

In that decade, the one when my generation was applying to art academies, the work samples requested were still largely model paintings and croquis drawings. It was recommended that we continue the practice of croquis, to maintain our vision—similar to the way a musician practices drills of scales, we were to practise our vision constantly. Apart from that, being left alone to work in the studio was regarded as the most important aspect of the pedagogical approach. But if an opportunity to meet with a teacher presented itself, a rewarding studio visit could help you progress in your work. It also represented an opportunity to receive confidence-inducing praise or severe judgement; some tutors thought of “breaking” a student as just part of the method, as they had all been subjected to the same treatment. My interviewees claimed that almost all studio conversations concerned the works that were physically present in the studio. Usually, the conversation would be about form (organisation of colour, line, light, and shade, for example) and whether artworks were “good” or “bad.” The art context, the concepts that inform the work, and the effect the work

has in the exhibition space were all topics less often discussed.

In the mid-1980s, the boundaries between the different traditional technical domains of painting, printmaking, and sculpture began to dissolve. Art academy education was further broadened in the late 1980s, when video and photography began to be taught. The students also gained greater influence over teacher appointments, and occasional guest lecturers who broke with the norm began to make appearances. Many of my interview subjects described the independent emergence of a peer-education culture inside the studios, where as students they had discussions about current exhibitions and different writings they came across (postmodernism and psychoanalysis were all the rage, as I recall). Many of us were already undertaking our own initiatives while we were still at school, opening artist-run galleries and holding exhibitions in temporary spaces—a trend that only intensified in the 1990s.

Several of my colleagues singled out a specific professor, Marie-Louise Ekman, and highlighted the change in tone in studio conversations that she brought about after being appointed professor of painting at the Royal Institute of Art in 1984. In a radio programme from August 2020, Ekman describes the studio visits she made in the 1980s: “What do you do to help somebody who wants to do something, but doesn’t know how, to find a way, or a language, a mode of expression,

that suits this particular individual, with their specific background and experiences? How do you speak to each other? What words do you use? What is the nature of the teacher-student encounter? Is it a case of a superiority versus inferiority, or do you find an approach that makes the power balance less significant?”¹³ Ekman’s words describe a development in the student-teacher relationship that began at this time, and which made the teacher’s role more akin to that of a sounding board, therapist, or even co-creator of sorts. This teaching role is far removed from the patriarchal, correcting master who dominated the academies for so long.

When I left Valand Academy in 1989, the ideal career trajectory for a Swedish artist followed a long-established path: get represented by one of the most prestigious galleries in Stockholm, get reviewed in *Dagens Nyheter*, produce a travelling exhibition and tour the institutions in smaller towns, do a solo at Malmö Konsthall, and, finally, have your big retrospective at Moderna Museet in Stockholm. After this, career success was fully confirmed by an appointment to a professorship at the Royal Institute of Art, a medal from the king, and a seat in the Royal Academy of Fine Arts. Showing your art outside Scandinavia was a rare occurrence, and, if it happened at all, it would be organised by a Swedish or Scandinavian

art institution. An artist who represented the nation in the Nordic Pavilion in Venice like this would be laurelled.

By the time the mid-1990s came around, things had been gradually turned on their head through a series of smaller increments, and the art world and the art market both became more international than ever. Sweden joined the EU, and a whole new generation of artists, curators, writers, and gallery owners, as well as the founding of IASPIS, the International Artists Studio Program in Stockholm, all contributed to this move from the local to the global.¹⁴ The emergence of a growing number of new art institutions, biennials, and art fairs gave artists from all over the world access to a larger stage.¹⁵ Meanwhile, significant steps were made on the path from analogue to digital technology—the fax machine entered the studio first, soon to be followed by the computer and the smartphone. A far more communicative and self-reflective artist role than the one I was trained to fill was dawning: the new artist spoke English and was expected to work on the global art scene. Croatian artist Mladen Stilinović made inspired fun of this new artist's role with his *An Artist Who Cannot Speak English Is No Artist* (1992).

When Malmö Art Academy was founded in 1995, the stated ambition was to create an education for the international artist, and the most important challenge faced by the school's newly appointed board

was that of turning the patriarchal structures of professorial education on their head and allowing the students to “take the responsibility for their own artistic development by designing their course of study.”¹⁶ Different varieties of knowledge and experience were to be mixed together, to “get away from unfortunate boundaries between techniques, between theory and practice, and between different areas of knowledge.”¹⁷ The ambition was to found a school that would both address and problematise the role of the artist, and provide the tools that artists need to work independently within the global art scene.

In 1997, I began to teach at Malmö Art Academy, where I have remained ever since, except for a leave of absence I took to pursue my own doctoral studies. I've spent most of my time here teaching and mentoring in the BFA and MFA programmes.¹⁸ When the school first opened its premises, in an old elementary school house on Föreningsgatan 42, the students all received their own studios, which they could lock and had free access to at any time of day. The decision was also made to have the students invite the teachers to their studios, rather than doing it the other way round. No teacher would have keys to, or find reason to enter, the studios unless the students gave their permission. The basic purpose of the studio visits was expressed by the school's Rector: “What passes in the meeting

between student and tutor may be a strain on both, or thrill for both, but it is never less than stimulating,” and further, “This is where the artistic experience is passed on and transformed, from one generation to the next.”¹⁹

In contrast with the narrow-minded, provincial view on art that dominated during my own education, contemporary art around the turn of the millennium could be described as a platform for experiments of form and perception or sociological and political investigations. With an art concept this broad, it followed that the teaching of artists would have to be broadened. Unlike the earlier, crafts-focused art education, which was divided into subcategories like painting, sculpture, and printmaking, fine art now encompassed any variety of two- or three-dimensional spatial expression, such as performance, installation, concept art, “new media,” activism, photography, video, and film. Art theory, philosophy, and critical studies—all subjects that would once have been viewed as exclusively academic—have made their way into the curricula of art academies.

These new requirements made it obvious that art students needed to practise their ability to express ideas related to their practice in writing and in conversation, and that it would be expected of them that they be able to relate their own practice to the approaches of other artists, both contemporary and historical. These expectations

caused some change in the conversations in the studios—students soon learned to provide succinct descriptions of their practices and apply a more project-like structure to their work for their graduation exhibitions. When Malmö Art Academy abandoned the old structure of the art academies, with five-year programmes, and moved to running its BFA and MFA programmes in accordance with the Bologna Process, studio visits became more purpose oriented: mentoring for the graduation show and graduation itself became a greater priority. The doctoral programme in artistic research has also influenced the BFA and MFA programmes. In purely concrete terms, students have learned to formulate project descriptions, and many of them have started to speak about their works as though they are research findings.

Today, much of the actual teaching is done in English, and art history and theory have become important components of the education. Professors and teachers on half- and part-time contracts are more common, because full-time teaching is almost impossible to combine with an international career in art. Many faculty members live elsewhere, and they visit Malmö to teach during focused blocks of time. We’ve also found it necessary to offer classes and workshops on many different techniques, as the students tend to develop a diverse array of practices. An abundance of guest tutors (curators, critics,

and other individuals from the art world) visit the school, and our students learn to receive critique from them and present their works to them in their studios. We also arrange lectures from researchers and thinkers in other fields relevant to art—postcolonial studies, sociology, archival research, philosophy, film studies, performance theory, and gender and queer theory, to mention just a few examples. Group seminars and group critiques have become more common at both the BFA and MFA levels, but the one-on-one conversation in the studio remains the foundation of much of the tuition, and it is entirely essential for graduation-project mentoring.

It's not as though you're done with studio visits when you graduate from school: presenting and discussing our works in the presence of curators, writers, and colleagues is part of our job. Applying for studio grants or working in other cultural contexts and other parts of the world for varying periods of time has become a way of life for many artists today. There's even a tongue-in-cheek term used to describe these working conditions: "residency hopping." On top of this, it's very common for artists to work in communally maintained and operated studio buildings. Historically, the painter's or sculptor's studio was, more than anything, a practical workshop for experimentation and production. Today, an artist's studio is equally their office, from where they administer

their production and their practice. My own studio is divided into two rooms: one where I paint and try out different ways of installing; this is also where I show visitors my works. The back room has a desk, which is where I'm writing these words, a bookshelf, my filing cabinet, and my inventory of artworks in storage. A student's studio also tends to serve all these functions, although to varying extents. Perhaps, though, we're facing a shift, one in which the importance of the studio will be challenged by other kinds of spaces.

The Norwegian artist Ane Hjort Guttu, who is also a professor at the Oslo Academy of the Arts, wrote in *Kunstkritikk* about the new art school buildings that have either recently been built or are still at the blueprint stage.²⁰ The old fine arts academies are being combined with other arts education programmes to form Anglo-Saxon-style campuses. Apart from being a money-saver, this model inspires visions of the creative exchanges that might occur between students of various disciplines in shared workshops, libraries, teaching spaces, and project rooms. Guttu describes how these ideas are translated into spaces, and about new kinds of larger workspace for projects: the project hall and the entrance hall. These are designed as central, large passageways, much like the indoor squares one finds in large office buildings and shopping centres—rooms that are expected to be filled by temporary collaborations

and workshops for all passers-by to see. "First and foremost, however," Guttu writes, "these areas express an ideology of openness, interdisciplinarity, flexibility, and cooperation associated with the 'sharing economy.'"²¹ Workshops, seminar rooms, and teaching rooms, as well as offices for administrators and teachers, are all well planned and well placed within an easily surveyable architecture. Guttu claims that the people who planned these school buildings had a particular artist role in mind—one that defines their artistic work as a form of research. However, this imagined researcher is the creative entrepreneur or project manager type, who essentially needs nothing but their computer to work and who doesn't mind working in an open-office layout or "learning landscape." Comparisons might be drawn to the architecture chosen by major IT businesses like Google, Apple, and various gaming studios in recent years—open spaces that are expected to boost creativity.

A common issue shared by many of these new facilities relates to the individual studios used by students of fine arts: either no plans have been made for such studios, or they exist but are too office-like and too small. In some of these schools, the students have had to insist that studios be built after the fact using room dividers. When Lund University was planning Malmö Art Academy's move to new, temporary premises a few years ago, the school's board, along with the

faculty and students, united to emphasise the importance of providing a functional work room for each of the school's fine arts students. In many ways, the new studios in Båghallarna are actually more suitable than the ones in the old building on Föreningsgatan. Since Malmö Art Academy will be moving again in a few years, to a campus building that is to be shared with Malmö Theatre Academy and Malmö Academy of Music, the issue of student studio layouts will no doubt become a renewed concern.

When hosting the radio programme *Sommar* (Summer), Marie-Louise Ekman asked: "How do you speak to each other? What words do you use? What is the nature of the teacher-student encounter?"²² I see a clear change here compared to when I first became a student myself, more than forty years ago. Because the students meet with so many different people in their studios, they don't seem to suffer the same awkwardness I did in attempting to explain my artistic ambitions to my teachers, and I'm usually treated to a slick, well-rehearsed pitch of their practice. It's quite common for us to spend the first studio visit going over a number of works the student has made and to have them present their method and their intentions to me. Both of us take the young artist and their work to be the focal point of the studio conversation. They were the one who invited me into their workroom,

after all. Those are the conditions, and the student's practice and works set the tone. In other words, they decide what I get to see and what we will talk about. I ask questions about what I see or hear, and try to hold back my own associations until I feel confident that I'm genuinely on to something. I deliberately avoid judgements like "successful," "good," and "bad." Rather, I discuss different possibilities and directions to try to help the students become aware of the choices they've made. I largely trust in my gut instincts and the experience I've developed from viewing a lot of art and working on my own art—but I also lean on the experiences that I've made discussing art with many young artists over the years.

These conversations can evolve very differently depending on the needs of the specific situation and how well the student and I know each other. Some relationships deepen over time, and we begin to meet more frequently. Perhaps, if sufficient trust develops between us, they will choose me to be their mentor for their final-year art project, which leads up to their graduation exhibition. Other studio visits will be more sporadic affairs. The students have many teachers to turn to, and perhaps they will feel more closely aligned with another artistic position—or perhaps a student might seek out a certain teacher based on their particular skill set.

In recent years, the internet-connected computer and smart-phone have become core teaching tools. In the interviews with my colleagues, they confirmed my own view that the dialogue in the studios has become more dynamic as a result of our being a mere push of a button away from accessing references or images that have immediate relevance to our conversation. We can also view the student's documentation or works together on a computer screen or smartphone. Some students have websites where they post their works, and others share their practice on social media. Links to texts, films, and artworks are sent back and forth between us, before and after the conversations. Studio visits can be complemented with remote follow-up meetings—which I usually do from the computer in my own studio. During the spring term of 2020, when the coronavirus pandemic was raging, carrying out studio visits through Zoom became a common practice.

Digitalisation has dissolved the studio space and changed the way artists work. How does this impact studio conversations and the artist's studio itself? That's hard to say, but we know one thing for sure: whenever we go through a technological shift, we always lose something important that we perhaps should have kept. I'd still like to endorse the value of the locked, private studio, the "room of one's own," as the novelist Virginia

Woolf put it, which has as its main virtue the simple fact that other people can't see inside. Here, the artist-student is free to experiment and fail, and, most importantly of all, to not have to face judgement during the actual execution. In my experience, interesting and innovative artworks often result from some errant

thought or bodily impulse—a motion that occurs before any thought about what the artwork is and does has fully formed. It is these attempts to define what art can be and do that become the subject of our discussions in the studios—and that's what makes this kind of conversation such an important and wonderful experience.

1 Kent Lindfors, "Några förvirra(n)de stycken kring en plats," *Konsthögskolan Valand Katalog '86* (Gothenburg: Valand Academy, 1986).

2 Larry Shiner, *The Invention of Art: A Cultural History* (Chicago: University of Chicago Press, 2001).

3 Shiner designed this table based on French literary historian Annie Becq's ideas on the transition from patronage to market as a move from "concrete labour" to "abstract labour," necessitated by the shift from use-value to exchange-value.

4 "Vad gör rutnätet?" (What does the grid do?) was the title of my research project and, simultaneously, the complex research question I have posed in relation to painting and new technology, based on my art practice and past experience teaching artists. I've worked on this project at Malmö Art Academy since 2019, with funding from the Swedish Research Council. The project will end in December 2021, when it will result in an exhibition and a book.

5 My interview subjects were Ewa Brodin, Lena Bjerneld, Ann Edholm, Carin Ellberg, Thomas Elovsson, Martin Gustavsson, Peter Hagdahl, Kent Lindfors, Håkan Rehnberg, Sigrid Sandström, Kjell Strandqvist, and Sophie Tottie.

6 There have been a number of preparatory art schools in Scandinavia for some time. For example, Gerlesborgsskolan, Pernbys målarskola, and Konstskolan Idun Lovén in Stockholm, as well as KV Konstskola and Göteborgs konstskola in Gothenburg. To stand a chance at gaining admission to the art academies, most students will first get their basic education in these preparatory schools.

7 I'll relate it in reverse chronological order to reveal the connection: my teachers, who taught me the grid technique in 1977, were Birgit Ståhl Nyberg and Hendrik Nyberg; Ståhl Nyberg and Nyberg studied under Ragnar Sandberg at the Royal Academy in Stockholm; Sandberg, in turn, studied under Tor Bjurström at Valand Konstskola in Gothenburg; and Bjurström studied under Henri Matisse at Académie Matisse in Paris in 1909. The catalogue for the *Inspiration Matisse* exhibition at Waldemarsudde, Stockholm, contains several written accounts of the teaching at the Académie Matisse. Anna Meister, Daniel Prydz, and Karin Sidén, eds., *Inspiration Matisse!* (Stockholm: Carlssons förlag and Prins Eugens Waldemarsudde, 2014).

8 Two important books for this pedagogical approach were published by Björn Melin, a painting teacher at Gerlesborgsskolan in Stockholm: *Måla och se* (Stockholm: Wahlström & Widstrand, 1973) and *Teckna och måla modell* (Stockholm: Wahlström & Widstrand, 1979).

9 Last autumn, when I returned to lecture at a preparatory art school in Stockholm, I took a walk among the easels to get a closer look at the depictions of the model's current pose. Everything was just the same as I remembered it in that room—but also, I realised, upon looking closer at the students' paintings, so very different. The awareness of volume seemed to have been forgotten, or deemed insignificant—all the figures in the paintings were flat, like paper dolls. But perhaps it only seemed that way to me?

10 I explored this in my postdoctoral project, *Neanderthal Landscape*, Malmö Art Academy, 2009–10, and a related exhibition at Kunsthalle Düsseldorf in 2010. For more information on the project, see Matts Leiderstam, "Neanderthal Landscape — After the Dissertation," *MaHKUzine: Journal of Artistic Research*, no. 10 (Summer 2011).

11 For more information on Swedish art education, I refer the reader to art historian Marta Edling's interesting research on education in fine arts from 1960 to 1995: Marta Edling, *Fri Konst? Bildkonstnärlig utbildning vid Konstfackskolan, Konsthögskolan Valand och Kungl. Konsthögskolan 1960–1995* (Gothenburg: Makadam Förlag, 2011).

12 Gun Maria Pettersson was appointed a professorship from 1983 to 1986 at the Royal Institute of Art in Stockholm. According to Marta Edling, Marie-Louise Ekman was the first woman to be recruited for a professorship at the Royal Institute of Art.

13 Marie-Louise Ekman, *Sommar*, radio broadcast, SR, originally aired August 9, 2020, <https://sverigesradio.se/sida/avsnitt/1518810?programid=2071>. Translated by Jan Salomonsson and the author.

14 One of the few doctoral theses that discusses the time in question is Jonas Ekeberg, *Postnordisk—den nordiska konstscenens vekst og fall 1976–2016* (Oslo: Torpedo, 2019).

15 At this juncture, I'd like to refer to an interesting book about the global art market: Maria Lind and Olav Velthuis, eds., *Contemporary Art and Its Commercial Markets: A Report on Current Conditions and Future Scenarios* (Tensta: Tensta Konsthall; Berlin: Sternberg, 2012).

16 Gertrud Sandqvist, foreword to *Malmö Art Academy Yearbook 1996–1997* (Malmö: Malmö Art Academy, 1997).

17 Sandqvist, introduction to *Malmö Art Academy Yearbook 1996–1997*.

18 Lund University appointed me to a vacant position, half-time, as Professor of Fine Arts. The position was listed in October 1997. I applied, and on September 1, 1997, I was appointed a three-year professorship with the option to extend. In 2001, I stopped teaching and returned as a half-time professor in 2011, a position that was discontinued during the spring term of 2018. Since then, I have worked as an external mentor.

19 Gertrud Sandqvist, foreword to *Malmö Art Academy Graduation Students 1999* (Malmö: Malmö Art Academy, 1999).

20 Ane Hjort Guttu, "The End of Art Education As We Know It," *Kunstkritikk*, May 22, 2020, <https://kunstkritikk.com/the-end-of-art-education-as-we-know-it>.

21 Guttu, "The End of Art Education As We Know It."

22 Marie-Louise Ekman, *Sommar*.

Concentric Pedagogy: Towards an Ethics of the Observer

2

Mary Kelly

2018

This text is an amended version of a talk presented at the Whitney Independent Study Program's 50th Anniversary Symposium, Whitney Museum of American Art, New York, October 18-20, 2018. Reprinted by permission of the author.

Since the 1980s, critical pedagogies have been informed by feminism, but here I would like to consider feminism as a tactic rather than a content. So I will focus, briefly and schematically, on one of the central curricular components of studio art in an institutional context, that is, the critique, and my revision of it, dubbed matter-of-factly “the method” by students in the Whitney Museum’s Independent Study Program in New York and the Interdisciplinary Studio area at the University of California, Los Angeles, as well as the graduate program of the Malmö Art Academy.

Let me begin with an anecdote. When I went to teach at the California Institute of the Arts as a visiting artist in 1987, Michael Asher was giving his legendary critique session, which put the artist in the hot seat, subject to rigorous interrogation for hours on end. At the same time, I was introducing my version of the “close reading,” with viewers huddled in

a circle and the artist an observer at the periphery. As the term went on, students started joking about it: "Are you taking the 'phallogocentric' crit or the 'concentric' crit?" That was when I first started to think more self-consciously about my pedagogy's relation to feminism.

One of the primary imperatives for feminists in the 1970s was that we not speak for others. Because of my exposure to the practice of *listening* in consciousness-raising groups and the non-hierarchical forms of organisation that we practised in the London Women's Liberation Workshop, I was disposed to question the prevailing method of critique in art schools at that time. At Goldsmiths, where I was then teaching, this meant asking the artist to explain his or her intentions, which prompted a massive amount of projection on the part of the viewers such as, "Why did you do this?" or "I would have done that," which seemed to overlook the fact that the work of art is essentially a visual proposition. As a signifying system, that proposition is legible on its own terms, and the artist's verbal defence does not necessarily give him or her a voice. Instead, I felt we had to *look*, and to understand this looking as a *form of listening* to the artist *through the work*. Moreover, I began to think that not to do so was, in some sense, unethical.

For the philosopher Giorgio Agamben, there is a certain kind of mediality that evades the orbit of means and ends. Nothing is produced or enacted. Instead, something is supported or endured, and this stance without purpose, he suggests, allows the ethical dimension of human experience to unfold.¹ But as often occurs in a critique, looking at art becomes entangled with making it, and we reach an impasse. Whatever drives an artist's truth procedure verges on a certain kind of terror; that is, the passionate

fidelity to an idea that is necessary to enact it. Yet this seems to be precisely what must be relinquished to be an ethical observer. Unlike what we typically think of as a critical engagement with the work, the ethical stance rejects judgement in favour of anticipation, and this in turn has implications for the process of decipherment. In my teaching practice over the years, this has entailed rethinking the question of spectatorship as a subject position distinct from the producer and his or her creative process.

Anticipation is crucial to the formation of this psychic disposition. Here I am thinking not only of the psychoanalytic meaning of the term but also of philosophical formulations like those of René Descartes, who describes wonder as anterior to passion because it has no opposite and no affect. We are simply astonished by our encounter with the object. Extending his argument from a feminist perspective, Luce Irigaray says we wonder before judging and, in doing so, open ourselves up to difference without divisive hierarchies.² In the crit class, we might not be astonished by the object, but the suspension of aims might endow us with the generosity required to proceed. We are just *looking*, trying not to read the wall text, or to think about who the artist is, or what we will be doing after class, but simply making ourselves vulnerable or open to the situation. The object encounter may or may not be what we want it to be, but both projection and introjection foreclose the possibility of knowing what it *is*. To decipher a visual proposition, first it is necessary to acknowledge its difference unconditionally.

The postcolonial and literary theorist Gayatri Spivak has identified the violence of interpretation and forced analogies, and I would argue that the process of decipherment must be *not* an interpretation but rather a careful

transcription of the signifying system of the work, the outcome of which surprises us and, occasionally, even the artist.³

The critique, as I have structured it, resembles psychoanalyst Jacques Lacan's "three times of analysis": seeing, understanding, and concluding. But to witness the full "aha effect" of that surprise at the conclusion, it is imperative, in the beginning, for the tactic of close reading to remain open for as long as possible by focusing on the materiality of the signifier, slowing down the quick fix of the signified and the headlong rush to the sign. In the very first instant of seeing, something physical or somatic is registered in the body as a set of signifying relations to a specific object. Elements such as lighting, sound, scale—everything up to and including the frame or its absence (or, if it's an installation that includes the spectator, its extension)—define the encounter primarily as a phenomenological event. But it is much like the future perfect tense in the language of the unconscious: inflected by an imaginary certainty still to come but at the same time affecting the present. That is to say, we bring to the initial encounter a set of already received ideas that constitute another kind of frame.

Here the scope of our interrogation is limited to the "global" (as opposed to Spivak's notion of "planetarity") because art schools are currently circumscribed by disciplinary practices that reflect the orbit of investment capital and Eurocentric genealogies of fine art. But importantly, as literary scholar Emily Apter has pointed out, artists do not necessarily reproduce imperial trajectories in their work. Almost always they reinvent, subvert, or hybridise both modernist and regional genres, producing deconstructive visual propositions that contest those orthodoxies.⁴

The "institutional baggage," as I often refer to it, takes a long time to unpack, as students will

testify. But we do eventually get to the internal signifying system of the work, which is where the action is, in terms of understanding how those subversive rhetorical devices function in a designated visual field. By beginning with the smallest visual or acoustic unit that can be combined with a concept in a process of signification—the brushstroke in a painting, the planes of a three-dimensional object, the pixels in a digital print, a performer’s single gesture, even a perishable materiality such as noise—and then proceeding to the sign, a logic emerges in the evidence of what has come before. Impasto, for example, forms an existential bond with the brushstroke, favouring the index, while the icon often demands modelling in the mode of relief, which in turn supports the narrative organisation of perspectival representation—foreground, middle ground, background, and so on—leading to a consideration of the particular combination and substitution of signs that shape the signifying system overall and the privileged figures of rhetoric that underwrite the proposition and, crucially, let us know when to quit. When it works, I have found this to be the most astonishing point in the process: there is a collective recognition that to carry on would disrespect the artist’s intention, which is, at the same time, an admission of the intensity of our various subjective investments in the outcome. Concluding, then, becomes an opening for the coming-into-being of the ethical observer.

The trajectory of analysis that brings us to this point is entirely collaborative, and for this reason, I have been reticent to write it down as *method*, in any prescriptive sense that would represent it as a discourse of mastery. On the contrary, a crit(ique) session is time sensitive and unrepeatably. Ending one is always inconclusive, because we have aspired only to make the

proposition comprehensible in the present—this place, this moment in history. Nevertheless, the tactics of listening and collective enquiry we have deployed, which are also evident more widely in the present effort to decolonise our academic discourse, bear the tangible imprint of feminism’s practical past.

1 See Giorgio Agamben, *Means without End*, trans. Cesare Casarino and Vincenzo Binetti (Minneapolis: University of Minnesota Press, 2000).

2 See Luce Irigaray, *An Ethics of Sexual Difference*, trans. Carolyn Burke and Gillian C. Gill (Ithaca, NY: Cornell University Press, 1993).

3 See Gayatri Chakravorty Spivak, *Death of a Discipline* (New York: Columbia University Press, 2004).

4 See Emily Apter, *Against World Literature: On the Politics of Untranslatability* (New York: Verso, 2013).

Image pp. 44–45:
Mary Kelly, *Gloria Patri*, 1992. Etched and polished aluminum, 31 units. Installation view, Lunds konsthall, 2017. Courtesy of the artist and Susanne Vielmetter, Los Angeles Projects. Image courtesy of Lunds konsthall





Collective Pockets of Dialogue: Between Practice, Pedagogy, and Critical Thinking

3

2018

Maj Hasager

This text builds upon a presentation given at the symposium *Front Lines, How Might We Talk about the Future?* as part of “Panel 21: Art/Education in the 21st Century,” organised by the China Academy of Art and National Institute of Art in Beijing in March 2018. Republished by permission of the author.

“Communities of practice are groups of people who share a concern or a passion for something they do and learn how to do it better as they interact regularly.”

— Etienne and Beverly Wenger-Trayner¹

In this text, I draw upon the experiences of the Critical & Pedagogical Studies MFA programme at Malmö Art Academy. I and a group of my fellow instructors established Critical & Pedagogical Studies (CPS) in 2011 to unfold what might happen when an art academy sets out to test formats across disciplines, which tend to be divided, and investigate the intersections between practice, pedagogy, and critical thinking

within an MFA programme. Rooted in the role of the practitioner—that is, the artist-teacher—the programme produces a space for critical reflection upon the multiple positions that artists can inhabit.

Before I begin describing the CPS programme in more detail, I will make a brief introduction to the structure of Malmö Art Academy.

When looking at contemporary art education in Sweden, we see that the traditional apprenticeship structure hardly exists any longer, and it is rather the students' practice and development that is the focal point of the teachers' activities.² In today's art education, students are expected to be able to make use of self-directed learning as a tool for development throughout their education. Self-directed learning is described as a process by which individuals identify their learning needs and goals on their own initiative, with or without the assistance of others, and have the ability to evaluate the learning outcomes of a situation.³

Though experience shows that students find it difficult to enter self-directed studies after attending formally structured preparatory schools, studies also show how students learn to take control of their own learning process in art academies. For example, through studio visits where they are the ones who choose which tutor to speak to and when, as described in professor Ann-Mari Edström's 2008 study on the studio visit.⁴

Malmö Art Academy has no separate departments and, in order to break down hierarchical power structures often present in art academies, no teacher, professor, or guest lecturer is allowed to enter a studio or workspace without a prior invitation from the student.

Students in the BFA and MFA studio programmes organise their own curricula, choosing from a wide range of courses on topics such as art theory, artistic techniques, and artistic interpretation. The situation is different for the Critical & Pedagogical Studies participants, who need to adhere to a course structure with a dialogically based collective setting, but the programme still attempts to be an experimental platform where the students affect and partially shape a flexible curriculum.

At Malmö Art Academy, we see strength in creating a space for a multitude of artistic practices. Each year, a different constellation of artistic practices appears, depending on the group of students accepted into our different programmes. To facilitate the changing needs of the student body, we have implemented a flexible structure, which allows us to bring in external experts to match the individual students' needs as required.

This is a model that works well for us across the different programmes at the Art Academy, and allows us to put our thinking into practice. That is, this set-up allows us to actually test different ways of working in practice and to have the flexibility to adapt by making changes along the way. One of the core issues is trust—to have trust both in the students and in the teachers—which means we accept that processes take time, and

that we underline the importance of letting a thought develop all the way to the end, no matter how long this may take. When speaking of trust, it is also important to highlight that it is the students who have the lead regarding their artistic process—not the teachers. Once accepted, the students are not directed by staff and faculty; they themselves are in charge of how they structure their individualised education.

Malmö Art Academy has four different programmes and a total of seventy-five students. First, there is a Bachelor of Fine Arts studio programme, which is a three-year programme consisting of a foundation course, individual work in the studio, and individual tutoring, and which ends with a group exhibition and an essay.

The second programme is the Master of Fine Arts studio programme, which is a two-year graduate programme that includes in-depth research through individual studio practice and self-chosen courses, and ends with a solo exhibition and an essay.

The third programme is the four-year PhD programme, which is an experimental and highly individualised programme that focuses on identifying, understanding, and developing artistic thinking as a specialised field of knowledge production.

The fourth programme⁵ is the two-year Master of Fine Arts

in Critical & Pedagogical Studies, which differs in its structure and learning situation from the MFA studio programme, as I've already mentioned. CPS is an international programme that leads to an MFA degree, and it works across the borders between art theory, art practice, and pedagogy. The core of the CPS programme is structured around each iteration's small group of students; we accept up to ten individuals every other year. This allows for a dialogical learning situation where exchange and participation is essential. The programme is continuously developed from semester to semester to keep the structure as open as possible (within the institutional framework) and to allow experimental progress to unfold through creative processes. We encourage the CPS students to take part in this ongoing development and to acknowledge the different experiences and knowledges present in the seminar room. This is in line with what education theorist John Dewey calls an "experiential continuum"—each experience carries the past and modifies the future, which means we also need to rely on experience when it comes to developing education.⁶

A main objective of the CPS programme is to create a foundation for developing communicative skills through an understanding of how to mediate and educate—allowing space for on-adaptability

in order to push the boundaries of education and pedagogy in relation to artistic research and practice even further. The pedagogical focus area is the strengthening of artistic praxis, grounded in both theory and practice. A key pedagogical component of the programme is a practical internship during the third semester. Here, the students are able to explore the notion of pedagogy as practice and the position of artist as educator or artist as mediator. This is shaped through the process of the students' own individual projects and research during the placement. The CPS students gain hands-on experience of educational situations in order to test out experimental pedagogical strategies on a practical level and in a way that stems from their own individual artistic practices.

These internships take on different characters depending on the variety of artistic practices of the current cohort. Projects have ranged from creating collective working models for a group of cultural producers in Portugal, to developing alternative models to the studio visit as an attempt to look at power structures. The internship has proven to be a very valuable pedagogical tool, since it allows the students to contextualise the theory in practice and to develop their vocabulary through their artistic practices.

In the CPS programme, courses often take place around a table in

our shared workspace, where every participant is included and asked to contribute to the conversation. Courses can also consist of movement sessions, such as city walks or site visits, in an attempt to break free from the learning environment of the seminar table—something that has turned out to be difficult for many guest lecturers. Being placed around the table can feel like a safe zone, where one is acquainted only with the half-bodies of others, each person cut in two by the seminar table or the computer screen, as the Italian critic and media activist Franco “Bifo” Berardi puts it. He claims that media virtualisation and the exploitation of the intellect has destroyed the empathy among bodies, the pleasure of being in contact with each other, and the pleasure of living in urban spaces. So, how do we understand the fabric of a dialogical learning situation — not only by looking at the spaces where the exchange takes place but also by reflecting upon how it affects the learning?

What if we dare to take a step back and observe rather than follow preconditioned ideas, and what if we—in the spirit of bell hooks⁷—recognise what we each bring to the classroom? Can we then facilitate pockets of dialogue in which learning can take place?

When thinking of dialogical-based learning, we need to keep in

mind that most educators at art academies are either artist-educators or theoretician-educators, which means the individual practice comes first and the role of the teacher second, as is pointed out in Edström's research. Such educators speak from their fields of interest and personal viewpoints, which allows them to enter the dialogue without didactic methods, since most are interested in developing their fields further. There is of course a difference between traditional studio programmes, where students are left in periods of solitude, and more structured programmes, such as Critical & Pedagogical Studies, where students are expected to enter planned group situations as part of their education. Through communication between the teacher and the learner, a gap is created in which education takes place, a process described by Gert Biesta, professor of education at Brunel University London. This space for communication should be acknowledged for its uncertainties, risks, possibilities, and relations. It is in this gap, this in-betweenness, that education can take place. "Ultimately we cannot have a theory in education," argues Biesta, since "the gap in which education takes place is, after all, ultimately unrepresentable." However, this does not mean that we can dismiss the gap due to its lack of representation, since it is only from this "transformative" gap that

learning can take place.⁸ That is, only in the dialogical "gap" can we perform a more egalitarian communication between teacher and learner. And in acknowledging the gap, education can simultaneously exist as a discipline within the framework of the institution.

Biesta also points to the ambiguity in pedagogy when it comes to art education. Students are expected to interact with openness and uncertainty as part of the creative process so as to learn how to negotiate the complex and unpredictable working situation of an artist.⁹ How is it then possible to speak about an educational strategy within art education, if the conditions for such pedagogy are precarious?

It can at times be quite challenging for the students in the CPS programme to navigate its flexible and open-ended curriculum, and for them to experience the two-year MFA course as a holistic endeavour. Though many have been students at an art academy before — and are familiar with self-directed studies — it is a challenge for them to enter a group situation for two years and to have to develop new knowledge at the intersections between artistic practice, pedagogy, and critical thinking.

Our intention is to form what the social-learning theorist Etienne Wenger-Trayner terms a "community of practice" through regular group sessions, both formal and

informal. He defines “communities of practice” as “groups of people who share a concern or a passion for something they do and learn how to do it better as they interact regularly.”¹⁰ A community of practice can serve as a strong peer-to-peer foundation, which extends learning together beyond the years in the art academy to become a continuous practice.

Allow me to quote a further central view of Wenger-Trayner’s:

The school is not the privileged locus of learning. It is not a self-contained, closed world in which students acquire knowledge to be applied outside, but a part of a broader learning system. The class is not the primary learning event. It is life itself that is the main learning event. Schools, classrooms, and training sessions still have a role to play in this vision, but they have to be in the service of the learning that happens in the world.¹¹

I would like to apply this concept to the combination of practice, pedagogy, and critical thinking—fields that the Critical & Pedagogical Studies MFA programme was the first in Europe to integrate back in 2011. Such a combination seems to reflect the reality of many artists, who inhabit multiple positions in a practice. Yet somehow it seemed radical within the formal structures

of an art academy, and perhaps it is still seen as such even today. For instance, simply mentioning the word “pedagogy” can still trigger some awkward responses. It is rarely described as an aspect of artistic practice and usually used only indirectly when discussing art education through terms like “learning strategies.” Perhaps it is because pedagogy is still so strongly associated with the traditional teacher-pupil situation witnessed in classrooms all over the world that using the word in a broader sense can be seen as a challenge. One CPS student did a small survey on the topic of “artists teaching artists” as part of her exam project, and she found that only half of the interviewed artist-educators answered “yes” to the question “Can art be taught?” Now, this could be a consequence of the teacher-pupil concept being conjured by the use of the word “taught.” Or perhaps it is that the saying “Those who can’t do, teach” is somehow still stuck in the minds of some when it comes to art education. The reality, though, is quite different; perhaps one could even say, “Those who can’t do, can’t teach.” In other words, it takes a practising artist to become a teacher in an art academy. The CPS programme reflects and is informed by this reality, in line with Wenger-Trayner’s view that education should be “in the service of the learning that happens in the world.”¹²

Nevertheless, it is a common thought that teaching implies giving up one's own artistic practice, either by choice or by necessity. It has likewise been presumed that the CPS programme must consequently be producing art school teachers. And, to be clear: no—we are in fact investigating multiple possible articulations in the field of art from the position of the artist. As I mentioned earlier, it is a current reality for many artists to inhabit multiple positions in their practice—a reality I like to refer to as a “hybrid practice.” The basic definition of “hybridity” is a biological mixture between two species, which can be seen both on a material level as well as on a practical level. In this case, I'm applying the notion of hybridity to describe a multiplicity embedded in a practice—in this instance, an artistic practice. This also resonates with the awareness of hybridity as a discourse that can replace the problematic idea of multiculturalism—as explicated in Homi K. Bhabha's 1994 book *The Location of Culture*,¹³ in which he pleads for a transnational culture liberated from Western multiculturalism and the celebration of cultural diversity, which is seen as a way of recolonising the subject.

Not only is hybridity a necessity for exploring multiple articulations in the field of art, but it is also often a prerequisite for making

a living by means of artistic practice. In this way, holding multiple positions can be seen as a way towards sustainability for the artist. However, one must also be aware of the issue of hybridity in the realm of neo-liberalism, where precarious working conditions have become the ultimate celebration of the so-called flexible and employable citizen, which have been further promoted by the current sociopolitical conditions in Europe. The fact that having multiple positions and roles could be perceived as simply a way of conforming to the neoliberal agenda means that an in-depth discussion on multiplicity in an artistic practice is needed as a critical self-reflection.

I argue that teaching and pedagogy can play a significant role in expanding the multiple positions that one can inhabit in an artistic practice. I would like to elaborate a bit on pedagogy as an artistic method and an artistic matter, in order to better address both its materiality and immateriality.

One way of looking at pedagogy, as a method that can be interwoven with an artistic practice, is through the term “work stories,” which was coined by the Swedish artist and writer Magnus Bårtås.¹⁴ He speaks about work stories as a tool for the artist in terms of self-narration. A work story is a written or oral narrative about the forming of materials, situations,

relations, and social practices that are, or lead to, an artwork. Work stories speak primarily about processes, and processes are ongoing, which means that work stories take place both in a zone of transition as well as in one of transaction. Self-narration in an artistic practice can be seen as having ties to pedagogy, as it is a form of embodied mediation. It is a process that traditionally lies outside the realm of artistic practice and thereby can function as an expansion of the artist's dialogue with an audience.

Bårtås furthermore addresses the importance of artists working and acting from their own set of premises when it comes to writing, talking, and sharing their work stories. This claiming of the space to speak for oneself as an artist can also be considered an artistic material through which processes can be revealed or hidden, depending on the chosen strategies. Though it can be an immaterial task to trace the shifts and transformations that occur in an artistic practice, one might say that mediation could be considered as a relational substance. In other words, it is a place from which the storyteller can open doors to rooms filled with speculation and anticipation, each having the potential to conceal or unravel the processes of the chosen artistic practice and material.

Coming back to Malmö Art Academy, where we aim

to create space for a multiplicity of practices—we set out to develop different forms of art education, one example being the Critical & Pedagogical Studies MFA programme. By establishing a space for collective exchange and dialogical learning situations for a small group of art students, individual and collective processes can coexist. One example of such a learning situation is the recent course “Practise Practice—Thinking through the Visual,” led by Professor Matts Leiderstam and myself, which ran across two semesters. Here the emphasis was on artistic research seen through the students' individual practices and collective processes. The teaching method from the outset was described as flexible and in constant dialogue with the development in the group — which meant fine-tuning the course curriculum from session to session in response to the students' research and interests. In collaboration with a local art institution in Malmö, Skånes konstförening, the fifteen participants took over its exhibition space for a month as a part of the course. They negotiated the various aspects of the use of the space and worked through self-organised and collective processes, which concluded with three evenings of public events. I would like to highlight the students' statement, which greeted the visitors at the entrance to the exhibition space:

Dear Visitor,

You are about to encounter the traces of multiple art practices developing in one space. Spatially and temporally, these practices weave in and out of the gallery and each other—experimenting. In this process, countless questions have arisen, but no singular answers. Together we've wondered ... How do we make collective decisions without consensus becoming an authoritative demand? How do we create space for the many, merging, manifold, and conflicting among us? To what extent do we build theoretical lines within the space and among ourselves? To what extent do we allow our practices to emerge organically?

We, the artists, have chosen to surrender singular authorship to explore an anonymous (or rather multiplicitous) practice and presence in the space. One claimed by many authors, voices, and views. We've inhabited the gallery, testing ideas and processes, playing with collectivity, meeting each week for dinner, as we've worked to navigate the gallery and our practices within it. Thus, you will find practices: pieces and ideas in process, fragments of research and experiments, and temporary

structures for discussion and coexistence. Samples, scores, and documents from our time and practices have accumulated in boxes we've crafted within the space. These are intended as archive and publication —traces and testimonies of our thinking through the visual.¹⁵

By allowing receptiveness in the teaching situation and placing trust in the students and their processes, and understanding when to facilitate a situation and when to step back, is indeed a fine balance to keep. Likewise, we must acknowledge that while some students would have liked more guidance, other students would have liked the course to be even more experimental. One of the most important tools is to facilitate a space where different opinions can be heard with respect. bell hooks notes in her book *Teaching to Transgress*: "To engage in dialogue is one of the simplest ways we can begin as teachers, scholars, and critical thinkers to cross boundaries." By constantly testing out different formats, practising the act of listening, and allowing space for thought processes, we become continuous learners and hopefully create collective pockets of dialogue where exchange can take place in solidarity—and also make space for multiple articulations, positions, experiences, and knowledges in the field of art.

- 1 Etienne and Beverly Wenger-Trayner, "Communities of Practice: A Brief Introduction," 2015, <http://wenger-trayner.com/wp-content/uploads/2015/04/07-Brief-introduction-to-communities-of-practice.pdf>.
- 2 Ann-Mari Edström, "To Rest Assured: A Study of Artistic Development," *International Journal of Education and the Arts* 9, no. 3 (2008): 24, <http://www.ijea.org/v9n3/>.
- 3 Malcolm Knowles, *Self-directed Learning* (New York: Association Press, 1975), 18.
- 4 Ann-Mari Edström, "Art Students Making Use of Studio Conversations," *Art, Design & Communication in Higher Education* 7, no. 1 (2008): 31–44.
- 5 At Malmö Art Academy, we have had a post-studio programme since 2000, which has taken different formats. Critical Studies was a one-year postgraduate programme run between 2000 and 2007, and it was developed into a two-year Masters of Fine Arts (MFA) in Critical Studies, run 2007–09. In 2010, the Critical Studies MFA was restructured into the two-year Master of Fine Arts in Critical & Pedagogical Studies, which ran until 2019. In 2020, a new version of the programme, titled Master of Fine Arts in Artistic Research (MFAAR), was launched, accepting between five and eight candidates who will develop individual artistic research projects. The purpose of the new programme is to prepare visual artists to define and formulate a research project in fine arts that aims at subsequent admission to a doctoral program in fine arts.
- 6 John Dewey, *Experience & Education* (New York: Touchstone, 1997), 33–50. First published in 1938.
- 7 bell hooks, *Teaching to Transgress: Education as the Practice of Freedom* (New York: Routledge, 1994).
- 8 Gert Biesta, "'Mind the Gap!' Communication and Educational Relation," in *No Education without Relation*, ed. C. Bingham and A.M. Sidorkin (New York: Peter Lang, 2004), 11–22.
- 9 Gert Biesta, "Mind the Gap: Expectations, Ambiguity and Pedagogy within Art and Design Higher Education," in *The Student Experience in Art and Design Higher Education: Drivers for Change*, ed. Linda Drew Group for Learning in Art and Design (GLAD) (Cambridge: Jill Rodgers Associates, 2008), 125–48.
- 10 Etienne Wenger-Trayner and Beverly Wenger-Trayner, "Communities of Practice: A Brief Introduction," 2015, <http://wenger-trayner.com/wp-content/uploads/2015/04/07-Brief-introduction-to-communities-of-practice.pdf>.
- 11 Wenger-Trayner and Wenger-Trayner, "Communities of Practice."
- 12 Wenger-Trayner and Wenger-Trayner, "Communities of Practice."
- 13 Homi K. Bhabha, *The Location of Culture* (London: Routledge, 1994).
- 14 Magnus Bårtås, "You Told Me – verkberättelser och videoessäer, Dissertation #19," *ArtMonitor* (2010).
- 15 The students who participated in the "Practise Practice" course were: Ursula Beck, Sanna Blennow, Clifford Charles, Marta Gil, Marija Griniuk, Anna Skov Hassing, Rebecka Holmström, Alexandra Hunts, Rannveig Jonsdottir, Cecilia Jonsson, Rune Elkjær Rasmussen, Karoline Sætre, David Torstenson, Aya Maria Urhammer, and Nanna Ylönen.
- 16 bell hooks, *Teaching to Transgress*, 130.

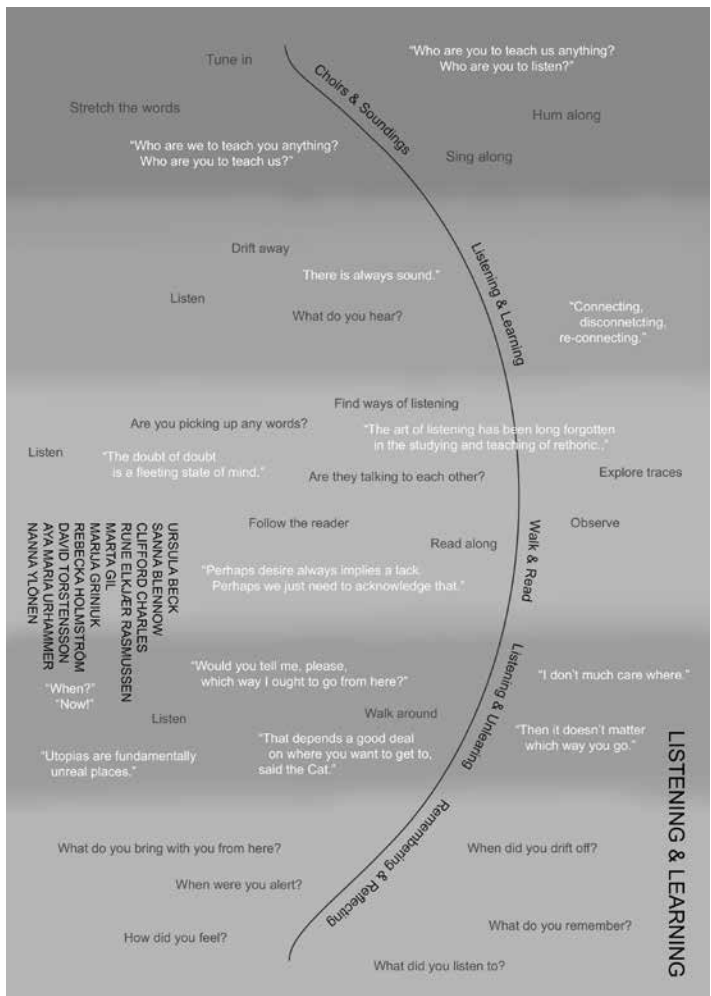

Hand out, "Invitations to Unlearn: Art Education and Critical Pedagogy," a presentation by students of Critical & Pedagogical Studies MFA programme as part of the project *Schools of Tomorrow: Test Run for the School of the Future* at Haus der Kulturen der Welt (HKW), Berlin, June 2018.

A Room of One's Own / A Thousand Libraries

4

Kajsa Dahlberg

2006/2020

Note: (1998–2020)

My time at Malmö Art Academy was one of those episodes in life that is so impactful that I do not fully remember who I was or how I thought before I began studying there. After that, a picture was never simply a representation anymore, a material never a resource, and I likewise could not remain the same. I learned how the freedom to create requires being part of a collective, both in terms of a history to identify with and as a peer group in the present.

It was at the Art Academy that I read Virginia Woolf's *A Room of One's Own* for the first time and feminism materialised as part of my body. A few years later I made a work that took Woolf's essay as its starting point which I called *A Room of One's Own / A Thousand Libraries* (2006).

In addition to Woolf's 1929 essay itself, *A Room of One's Own / A Thousand Libraries* was made in collaboration with library readers of the essay, as well as with the many librarians working in public libraries throughout Sweden in 2005 and 2006. The work is a republication of the Swedish translation of Woolf's essay—*Ett eget rum*—that compiles every marginal note made in library copies from all over the country. *A Room of One's Own / A Thousand Libraries* assembles almost fifty years of handwritten annotations made between the 1958 publication of the first Swedish translation and 2006, when the work was completed. It was published in an edition of one thousand. The following pages contain a few of its spreads, alongside some commentary from me.

med på vers, om jag så låge sömnlös i fjorton dygn skulle jag aldrig komma därefter."]

Och så kom det sig, att eftersom ingen förnuftig och blygsam kvinna kunde skriva böcker, så skrev Dorothy, som var kanslig och melankolisk av sig och ifråga om temperament raka motsatsen till hertiginnan, alls ingenting. Brev räknades inte. En kvinna kunde ju skriva brev medan hon satt vid sin fars sjukbädd. Hon kunde skriva dem vid brasan, medan männen satt och pratade, utan att störa dem. Det underliga är, tänkte jag, medan jag bläddrade i Dorothy's brev, vilken begåvning den olärd och ensamma flickan hade när det gällde att avfatta och ge form åt en mening eller gestalta en scen. Hör bara på, hur hon löper i väg.

"Efter middagen sitter vi och pratar till dess mr B. kommer på tal och då går jag min väg. Dagens varma timmar tillbringar jag med att läsa eller arbeta och vid sex- eller sjutiden går jag ut på en äng, som ligger nära huset, där en mängd ungmör vallar får och kor och sitter i skuggan och sjunger ballader; jag går ut till dem och jämför deras stämmor och skönhet med forntidens herdinnor, som jag har läst om, och finner en stor skillnad mellan dem, men ni kan tro att jag finner de nutida lika oskyldiga som någonsin de andra kunnat vara. Jag talar med dem och finner att de inte saknar något som kan göra dem till de lyckligaste människor i världen, förutom vetskapen om att de är det. För det mesta händer det, när vi är mitt uppe i samtalet, att någon av dem ser sig omkring och märker att hennes ko går i rågen och då springer de alla sin väg som om de hade vingar på fötterna. Jag som inte är så lättfotad stannar kvar, och när jag ser dem driva boskapen hem, tycker jag att det är på tiden att även jag drar mig tillbaka. När jag har ätit kvällsvard, går jag ner i trädgården och sedan till stranden av en liten flod, som flyter förbi, och där sätter jag mig ner och önskar att du vore med mig..."

Man skulle kunna svära på att hon hade fröet till en

den här mörka skriften
Gär 13 ena litteraturhistori -
Läng utredande och argumenterande uppsats

författarinna inom sig. Men "om jag så låge sömnlös i fjorton dygn, skulle jag aldrig komma därhän" — man kan mäta det motstånd som låg i luften mot att en kvinna skulle skriva, när man ser att även en kvinna med stor lättbet för att skriva har fått sig själv att tro att man skulle göra sig föllig, om man skrev en bok, ja till och med skulle verka förryckt. Och så, fortsatte jag medan jag satte tillbaka den enda lilla volym som innehöll Dorothy Osbornes brev på hyllan, så kommer vi till Mrs Behn, och i och med Mrs Behn har vi klarat en viktig krök på vägen. Bakom oss lämnar vi, inneslutna med sina foliovolymerna bakom parkgrindarna, dessa ensliga, högt ättade damer, som skrev utan publik eller kritik, enbart för sitt eget nöje. Vi kommer till staden och trängs med vanligt folk på gatorna. Mrs Behn var en medelklasskvinna med alla de plebejiska dygder som heter humor, viftalitet och mod; en kvinna, som genom sin makes död och några egna olycksaliga äventyr hade blivit tvungen att förtjäna sitt bröd på sin intelligens. Hon fick lov att arbeta på samma villkor som mannen. Hon förtjänade genom hårt arbete tillräckligt för sitt livsuppehälle. Vikten av detta faktum uppväger allt som hon egentligen skrev, till och med den strålände "A Thousand Martyrs I have made", eller Love in Fantastic Triumph sat", för här börjar tankens frihet eller snarare möjligheten att tanken med tiden kommer att få frihet att skriva vad den vill. För nu — när Aphra Behn hade gjort det, kunde flickor gå till sina föräldrar och säga: "Ni behöver inte ge mig något underhåll; jag kan förtjäna pengar med min penna." Naturligtvis var svaret under annu många år: Ja, genom att leva ett sådant liv som Aphra Behn. Hellre döden! varpå dörren stängdes hårdare till än någonsin. Det djupt fängslade ämne som utgöres av det värde män sätter på kvinnors kyskhets framträder här för

1. "Tusen martyrer har jag skapat."
2. "Kärleken satt i fantastisk triumf."

75



Intellectual freedom is dependent on material things / frigörelse

till en slav i Aten när det gäller att emanciperas och nå den intellektuella frihet, ur vilken stora litteraturverk uppstår."¹

Ingen kunde uttrycka saken tydligare. En fattig skald har i dessa dagar, och har inte på två hundra års tid, haft de minsta utsikter... ett fattigt barn i England har föga mera hopp än sonen till en slav i Aten när det gäller att emanciperas och nå den intellektuella frihet, ur vilken stora litteraturverk uppstår." Så är det. Intellektuell frihet är beroende av materiella ting. Poesi beror av intellektuell frihet. Och kvinnorna har alltid varit fattiga, inte bara i två hundra år utan från tidernas begynnelse. Kvinnorna har haft mindre intellektuell frihet än sönerna till slavar i Aten. Kvinnorna har alltså inte haft minsta utsikt till att kunna skriva böcker. Det är därför som jag har lagt så stor vikt vid pengar och ett eget rum. Men tack vare den strävan som nedlagts av de där önsända kvinnorna i det förlutna, som jag önskar att vi visste mera om, och egendomligt nog tack vare två krig, Krimkriget, som släppte ut Florence Nightingale ur hennes salong, och första världskriget, som omkring sextio år senare öppnade dörrarna för genomsnittskvinnan, håller dessa missförhållanden på att förbättras. Eljest skulle ni inte vara här i kväll, och er chans att fortjäna fem hundra pund om året, som jag tyvärr tror fortfarande är vanskelig, skulle vara ytterligt minimal.

Men ändå, invänder ni kanske, så varför fäster ni så stor vikt vid detta att kvinnorna skall skriva böcker, när det enligt er fordrar så stora ansträngningar, kanske förmår en att mörda sin faster, nästan säkert kommer en att bli försenad till lunchen och kan vålla att man råkar i mycket allvarliga dispyter med en del mycket hyggliga personer? Låt mig då få medge att mina motiv delvis är själviska. I likhet med de flesta engelska kvinnor som inte har fått någon uppfostran, tycker jag om att läsa. ①

1. "The Art of Writing" av Sir Arthur Quiller-Couch.

Why so important?
Så sant
onomi
nska

Kvinnans
avsaknad av
materiell
frihet.

anledningen

1
jag tycker om att läsa böcker över huvud taget. På sista tiden har min diet blivit en aning enformig; historien handlar för mycket om krig; biografierna för mycket om stora män, poesi har, tycker jag, visat tendenser att bli steril, och romanerna — men jag har tillräckligt blottat min oförmåga som kritiker av moderna romaner och skall inte säga mer om den saken. Därför skulle jag vilja be er att skriva alla slags böcker och inte tveka att gripa er an med något ämne, hur vardagligt eller hur vittomfattande det än må vara. Med lock eller pock hoppas jag att ni skall kunna skaffa er tillräckligt med pengar för att kunna resa och lata er, för att kunna filosofera över världens framtid eller forflutna, för att drömma över böcker och stå och hänga i gathörnen och låta tankens metrev sjunka djupt ner i strömmen. För jag ämnar ingalunda begränsa er verksamhet till romankonsten. Om ni ville göra mig till lags — och det finns många tusen som tänker som jag — så skulle ni skriva böcker om resor och äventyr och om forskning och vetenskap, och om historia och biografi, och kritik och filosofi och naturkunskap. Genom att det göra kommer ni med säkerhet att gagna romankonsten. För böcker har för sed att utöva inflytande på varandra. Romanerna kommer att bli mycket bättre om de står sida vid sida med poesi och filosofi. Därtill kommer att om ni ser närmare på någon stor gestalt i det förflutna som Sappho, som den ädla Murasaki, som Emily Brontë, så skall ni finna att hon är lika mycket arvtagerska som hon är nyskapare, och att hon blev till därför att kvinnorna av naturen hade fått för vana att skriva naturligt, så att en sådan verksamhet från er sida skulle vara ovärderlig som förspel till kommande dikter.

3
Men när jag blåddrar tillbaka i de här anteckningarna och kritiserar min egen tankegång medan jag gjorde dem, finner jag att mina motiv inte var helt och hållet själviska. Genom dessa anmärkningar och utveckelser löper övertygelsen — eller är det instinkten — att goda böcker är önskvärda och att goda författare, även om de

123

Krima
skriver naturligt.

en tanke, som är rent feminin, kan göra det, tänkte jag. Men det skulle vara bra att undersöka vad man menade med manligt-kvinnligt, och omvänt med kvinnligt-manligt, genom att göra ett uppehåll och ta sig en titt på ett par böcker.

När Coleridge sade att en stor ande är androgyn, menade han säkert inte att det är en ande, som har någon särskilt slags sympati för kvinnor, en ande som tar sig an deras sak och ägnar sig åt att uttolka dem. Måhända är den androgyna tanken mindre i stånd att dra dessa skillnelinjer än den enkönade tanken. Han menade kanske att den androgyna tanken är i stånd att ge genklang och i sig uppta vad som kommer utifrån, att den utan hinder kan vidarebefordra känslan, att den av naturen är skäpande, glödande och enhetlig. Man går faktiskt tillbaka till Shakespeares tanke som typen för den androgyna, den manligt-kvinnliga tanken, fast det vore omöjligt för en att säga vad Shakespeare ansåg om kvinnorna. Och om det är så att det är ett av den fullt utvecklade andens kännetecken att den inte tänker särskilt mycket på könet eller betraktar det som något för sig, hur mycket svårare blir det då inte nu att nå detta tillstånd än vad det någonsin förr varit. Där kom jag fram till böckerna av levande författare, och blev stående framför dem och undrade, om inte detta faktum låg till grund för något, som länge hade förbryllat mig. Ingen tidsålder kan någonsin ha varit så skrikande könsmedveten som vår: det bevisas av de där oränseliga böckerna av män om kvinnor i British Museum. Utan tvivel kan man skylla mycket på rösträttskampanjen. Den måste ha väckt till liv en utomordentlig önskan att hävda sig hos männen: den måste ha förmått dem att lägga en vikt vid sitt eget kön och dess kännemärken, som de inte skulle ha brytt sig om att tänka på, om de inte hade blivit utmanade. Och när man blir utmanad, även om det sker av några stycken kvinnor i svarta bahytter, så ger man igen, och om man aldrig förr har blivit utmanad sker det tämligen i

granit grästen

Man - Jag - fri

överkant. Det förklarar kanske några av de utmärkande drag, som jag minns att jag träffade på här, tänkte jag i det jag tog ner en roman av mr A, som befinner sig i blomman av sin ålder och tydligen åtnjuter högt anseende bland bokanmälarne. Jag slog upp den. Det var verkligen förtjusande att återigen läsa en manlig stil. Den var så direkt, så ärlig, öfver kvinnornas stil. Den lydde på en sådan tankfrihet, en sådan personlig frihet, ett sådant självförtroende. Man fick en känsla av fysiskt välbefinnande i närvaro av denna välnärde, väluppfostrade, fria ande, som aldrig hade rönt hinder eller motstånd utan från födelsen hade haft full frihet att utveckla sig åt vilket håll den ville. Men när jag hade läst ett eller ett par kapitel var det som om det hade legat en skugga över sidan. Det var en rak, mörk stolpe, en skugga som hade en förm som påminde om första bokstaven i ordet Jag.

Man började kika först på ena och så på andra hållet för att uppfånga en glimt av landskapet bakom den. Om det i själva verket var ett träd eller en vandrande kvinna var jag inte riktigt säker på. Ständigt blev man kallad till bokstaven J(ag). Man började bli trött på denne "Jag". Inte för att inte denne "Jag" var en högst aktningsvärd "Jag"; ärlig och logisk, hård som en nöt och genom århundraden polerad av god undervisning och god näring. Jag aktar och beundrar denne "Jag" av allt hjärta. Men — och så vände jag ett eller ett par blad medan jag letade efter någonting — det värsta är att i skuggan av denna bokstav J(ag) blir allting formlost och dimmigt.

Är det där ett träd? Nej, det är en kvinna. Men... hon har inte ett enda ben i sin kropp, tänkte jag medan jag såg Phoebe, för så hette hon, komma gående på stranden. Så reste sig Alan upp och strax utplånades Phoebe av Alans skugga. För Alan hade åsikter och Phoebe utsläcktes i flodvägen av hans åsikter. Och så, tänkte jag, så har Alan lidelser, och så bladdrade jag mycket fort i väg sida efter sida i en känsla av att avgörandet närmade sig, och det gjorde det också. Det ägde rum på stranden i solske-

Felöversättningar: ^{a shadow shaped} something like the letter "I" (som i Jag)

I

2
inte
sant
puh!
Jag
skrivand

8) avog
SE
ttigdomen har på tanken, och jag tänkte
iga gamla herrarna som jag hade sett
med pälsbitar på axlarna, och jag min-
skulle ha börjat springa, om någon av dem hade
nat, och jag tänkte på orgelns brus i kapellet och på
de stängda dörrarna till biblioteket, och jag tänkte på hur
ötrevligt det är att bli utestängd, och jag tänkte på att det
kanske är värre att vara instängd, och när jag tänkte på
hur säkerställt och välmående det ena könet var och hur
tradition och osäkerhet det andra, och på vilken inverkan tra-
dition och brist på tradition har på en författares tanke-
värld, så tänkte jag till slut att det var på tiden att vika
ihop dagens skrynkliga ormskinn med alla dess argument
och dess intryck och dess vrede och dess skratt och slänga
det under häcken. Tusen stjärnor gnistrade bortom rym-
dens blåa ödemarker. Man tyckte sig vara ensam med ett
outrännsakligt samfund. Alla mänskliga varelser låg och
sov — raklånga, horisontella, stumma. Det verkade som
om inte en människa rörde sig på Oxbridges gator. Till
och med hotelldörren öppnades vid beröringen av en
osynlig hand — inte ens en skoputsare satt uppe för att
lysa mig till mitt sovrum, så sent var det.

Oxford
Cambridge!

talas till
läsaren

ANDRA KAPITLET

Scenbilden var nu, om jag får be er följa med mig, föränd-
rad. Löven dalade fortfarande, men nu var det London
och inte i Oxbridge; och jag måste be er att föreställa er
ett rum likt många tusen andra, med ett fönster som tvärs
över människornas hattar och lastvagnar och bilar vette
mot andra fönster, och på bordet inne i rummet ett tomt
pappersark, på vilket med stora bokstäver stod skrivet
KVINNORNA OCH ROMANEN, men ingenting mera. Den
oundvikliga följderna av deltagandet i en lunch och en
middag i Oxbridge tycktes tyvärr vara ett besök i British

X egentligen
Women and
Fiction

frågeutläggningar
9
fördömlar
bryg ned
En öppen
under 19

Museum. Man fick lov att sila bort allt som var personligt och tillfälligt i alla dessa intryck och så få fram ett rent fluidum, sanningens quinta essentia. För det där besöket i Oxbridge och lunchen och middagen hade givit upphov till en svärm av frågor. Varför drack män vin och kvinnor vatten? Varför var det ena könet så välbeställt och det andra så fattigt? Vad har fattigdomen för inverkan på romankonsten? Vilka villkor är nödvändiga för skapandet av konstverk? — tusen frågor steg samtidigt fram. Men vad man behövde var svar och inte frågor, och svar kunde man bara få genom att rådföra sig med de lärda och fördomsfria, som har fjärrmat sig från tungans kiv och kroppens irringar och låtit resultaten av sin lärdom och forskning inflyta i böcker, som finns att tillgå på British Museum. Om man inte hittar sanningen på hyllorna i British Museum, var finns då sanningen? frågade jag mig medan jag letade rätt på penna och anteckningsbok.

Sålunda utrustad, sålunda förtröstansfull och spörjande, begav jag mig i väg att söka sanningen. Dagen var visserligen inte direkt regnig, men dyster, och gatorna i museets närhet var fulla av öppna kolhåll, genom vilka säckar tömdes; fyrhjuliga hästdroskor stannade och avlevererade på trottoaren askar, ombundna med snören, som förmodligen rymde hela den garderob som ägdes av någon schweizisk eller italiensk familj, vilken sökte lyckan eller en tillflykt eller någon annan eftersträfvansvärd vara, som vintertid finns att få i pensionaten i Bloomsbury. De vanliga hesa karlarna vandrade omkring på gatorna med krukväxter i skottkärror. Somliga skrek, andra sjöng. London var som en verkstad. London var som en maskin. Alla skyttlades vi fram och tillbaka på denna släta grundyta för att det skulle uppstå ett mönster. British Museum utgjorde ännu en annan avdelning av fabriken. Svängdörarna öppnades, och där stod man under den stora kupolen, som om man vore en tanke i den väldiga, skalliga hjässa, som bär en så lysande ring av berömda namn.

Historians
ans
brist



⇒ Woolf

Jag är nästan säker på att Mary Carmichael spelar oss ett spratt, sade jag till mig själv. För jag har samma känsla som på en berg-och-dal-bana, när vagnen i stället för att börja gå nerför, som man väntat sig, plötsligt gör en gir uppåt igen. Mary fuskar med det väntade händelseförloppet. Först bröt hon sönder satsbyggnaden, nu har hon brutit tidsföljden. Näja, hon har all rätt att göra båda delarna, om hon inte gör det för själva brytandets skull utan för att skapa. Vilketdera det är fråga om kan jag inte med säkerhet säga förrän hon har tagit itu med en situation. Jag skall låta henne få full frihet att välja vilken situationen skall vara, sade jag. Hon skall få göra den av konservburkar och gamla kittlar, om hon har lust; men hon måste övertyga mig om att hon tror att det är en situation, och när hon har åstadkommit den, måste hon ta itu med den. Hon måste ta språnget. Och, fast besluten att göra min plikt som läsare mot henne, om hon ville göra sin plikt mot mig som skribent, vände jag bladet och läste . . . / Förlåt att jag gör ett så här tvärt avbrott. Är inga män närvarande här? Kan ni försäkra mig att sir Chartres Biron inte står dold bakom det röda draperiet där borta? Är vi säkert allesammans kvinnor? Då kan jag få säga er, att de ord jag faktiskt läste här, näst faktiskt var dessa — "Chloe tyckte om Olivia". Ryck nu inte till. Rodna inte. Lat oss så här alldeles ensamma medge, att sådant understundom händer. Ibland tycker kvinnor faktiskt om kvinnor.

"Chloe tyckte om Olivia", läste jag. Och sedan slog det mig, vilken oändligt stor förändring som låg i detta. Kanske för första gången i litteraturen tyckte Chloe om Olivia. Kleopatra tyckte inte om Oktavia. Och hur fullständigt annorlunda skulle inte Antonius och Kleopatra ha blivit, om hon det hade gjort. Som det nu är, tänkte jag medan jag nog tyvärr lät tankarna förra sig en bit bort från "Livets äventyr", så är hela sakförhållandet förenklat, konventionaliserat, löjligt konventionaliserat, om man så vågade säga. Kleopatras enda känsla beträf-

är det
frihet
att
behåva
män?

fande Oktavia är svartsjuka. Är hon längre än jag? Hur bär hon håret kammat? Dramat fordrade kanske inte mer än så. Men vad det skulle ha varit intressant, om förhållandet mellan de båda kvinnorna hade varit mer komplicerat. Alla dessa förhållanden kvinnor emellan, tänkte jag medan jag snabbt i minnet återkallade det strålande galleriet av kvinnliga fantasigestalter ur litteraturen, alla dessa förhållanden kvinnor emellan är för enkla. Det är så mycket, som har utelämnats, som har fått förbli oprövat. Och jag försökte minnas något fall som inträffat under min läsning, då två kvinnor hade framställts som vänner. Det finns en ansats till det i "Diana of the Crossways". De har förstås förtrogna hos Racine och i de grekiska tragedierna. Då och då är de mödrar och döttrar. Men nästan utan undantag framställs de i relation till män. Det var egendomligt att tänka sig att alla de stora kvinnorna i romanlitteraturen ända fram till Jane Austens tid inte bara är sedda av det andra könet, utan sedda endast i förhållande till det andra könet. Och vilken liten del av en kvinnas liv är inte det, och hur litet är det inte som en man kan veta ens av det, när han iakttar det genom de svarta eller rosafärgade glasögon, som könet sätter på hans näsa. Därav kommer sig kanske de kvinnliga romanfigurernas egenartade natur; deras förbluffande ytterligheter när det gäller skönhet och skräck, deras skiftningar mellan himmelsk godhet och helvetiskt fördärv — för så tedde kvinnan sig för den älskade, allt eftersom hans kärlek steg eller sjönk, var lycklig eller olycklig. Detta är givetvis inte i lika mån sant om adertonhundralets romanförfattare. Där blir kvinnan mycket mer växlande och komplicerad. Kanske var det faktiskt önskan att skriva om kvinnor, som fick männen att så småningom överge det poetiska dramat som med sin våldsamt hade så litet bruk för dem, och hittade på romanen som varande ett mer lämpligt käril. Ändå är det fortfarande, till och med i Prousts författarskap, klart och tydligt att en man är förfärligt hindrad och ensidig

viktigt

sedda av män

43

har män mer vänner

44 kvinnor

44 relation till andra kvinnor

ironi

Komplettera historien

de naturligtvis skulle förläna en oansenlig titel så att kvinnorna kunde förekomma där utan att verka opassande? För ofta uppfångar man en glimt av dem i de stores liv, där de smyger sig bort i bakgrunden medan de döljer något som jag ibland tror är en blinkning, ett skratt eller kanske en tår. Och vi har ju i alla fall tillräckligt med levnadsteckningar över Jane Austen; det förefaller näp-^{penne} peligen nödvändigt att åter ta upp till behandling Joanna Baillies tragediers inflytande på Edgar Allan Poes diktning, och vad beträffar mig själv, skulle jag inte ha något emot att Mary Russel Mitfords hem och älsklingsplatser stängdes för allmänheten för åtminstone ett århundrade framåt. Men något som jag tycker är bedrö-^{ligt} ligt fortsatte jag medan jag återigen såg mig omkring bland bokhyllorna, är att man inte vet något om kvin-^{ornas} norna före det adertonde århundradet. Jag har inte någon bild, som jag kan vrida och vända på i tankarna. Här sitter jag och undrar varför kvinnorna inte skrev dikter på Elisabet I:s tid, och jag vet inte riktigt hur de uppfostrades, om de fick lära sig skriva, om de hade egna vardagsrum, hur många kvinnor som fick barn innan de hade fyllt tjuogoett år, kort sagt, vad de hade för sig från klockan åtta på morgonen till klockan åtta på kvällen. De hade tydligen inga pengar; enligt professor Trevelyan blev de vare sig de ville eller inte bortgifta innan de hade hunnit lämna barnkammaren, förmodligen vid femton eller sexton år. Det skulle, till och med efter dessa blotta rön att döma, ha varit synnerligen egendomligt, om någon av dem plötsligt hade skrivit Shakespeares skådespel. Jag, och jag tänkte på den där gamle herrn, som nu är död men som jag tror var biskop och som förklarade att det var omöjligt att någon som helst kvinna i gången, närvarande eller tillkommande tid skulle kunna äga Shakespeares geni. Han skrev i tidningarna om saken. Han sade också till en dam, som bad honom om närmare upplysningar, att katter i regel inte kommer till himlen, fast de nog, tillade han, har något slags själar. Vad

POISS
Shakespeare
Om kvinn
Gunn
Larsson

Hade en K. konnat skriva Shakespears verk?
NEJ, för K. ej utbild, hemmet osv.

de där gamla herrarna förr i världen besparade en mycken eftertanke! Hur försköts inte okunnighetens gränser bakåt när de nalkades! Katter kommer inte till himlen. Kvinnor kan inte skriva Shakespears skådespel.

Vare därmed hur som helst, så kunde jag inte låta bli att medan jag tittade bort på Shakespeares samlade verk uppe på hyllan, tycka att biskopen åtminstone hade rätt i en sak: det skulle ha varit helt och hållet omöjligt för en kvinna att skriva Shakespeares skådespel på Shakespeares tid. Eftersom lakta är så svåra att finna rätt på, så lät mig fantisera om vad som skulle ha hänt, om Shakespeare hade haft en underbart begåvad syster, som hette lät oss säga Judith. Shakespeare själv gick antagligen — modern var arvtagerska — i latinskolan, där han förmodligen lärde sig latin — Ovidius, Virgilius och Horatius — och grammatikens och logikens elementa. Han var, som var man vet, en ostyrig pojke som idkade tjuvskytte på kaniner, kanske sköt någon hjort, och fick lov att lite förr än han egentligen borde ha gjort det, gifta sig med en kvinna i närheten, som fick ett barn med honom lite förr än rätt och riktigt var. Den eskapaden kom honom att bege sig till London för att söka sin lycka. Han hade tydligen smak för teatern; till en början stod han och höll hästar vid sceningången. Mycket snart fick han arbete vid teatern, blev framgångsrik skådespelare och levde i universums mittpunkt, blev bekant med alla människor, utövade sin konst på scenbräderna, utövade sin kvickhet på gatorna och fick till och med tillträde till drottningens slott. Under tiden kan vi anta att hans utomordentligt begåvade syster stannade kvar i hemmet. Hon var lika äventyrslysten, lika fantasirik, lika pigg på att se världen som han var. Men hon blev inte satt i skola. Hon fick ingen möjlighet att lära sig grammatik och logik, för att inte tala om att läsa Horatius och Virgilius. Då och då tog hon fatt på en bok, kanske någon av broderns, och läste några sidor. Men så kom föräldrarna in och sade åt henne att stoppa strumporna eller hålla ett öga

Shakespeare
Och Shakespeares syster!
Syster
en
teori
uppfostran

avundsjukt

57

Vad för
kvinnor
ej skrev

= det stora problemet

förvara mellan bladen i era anteckningsböcker och för evärdliga tider ha liggande på kaminfrisen. Det enda jag kunde göra var att framlägga för er en åsikt beträffande en mindre detaljfråga — en kvinna måste ha pengar och eget rum, om hon skall kunna skriva romaner; och som ni förstår, kvarstår på detta sätt det stora problemet om kvinnans verkliga natur och romanlitteraturens verkliga natur olöst. Jag har undandragit mig skyldigheten att nå fram till en slutsats ifråga om dessa båda frågor — kvinnorna och romanlitteraturen förblir vad mig beträffar lösta problem.) Men för att lämna något slags gottgörelse skall jag efter bästa förmåga visa er, hur jag kom fram till denna åsikt om rummet och pengarna. Jag skall i er närvaro så fullständigt och öppen- hjärtigt som jag kan framlägga den tankegång, som förde mig fram till denna åsikt. Det kan ju hända att om jag blottlägger de föreställningar, de fördomar, som ligger bakom detta påstående, så kommer ni att finna att de har en viss betydelse för kvinnor och en viss betydelse för romanlitteraturen. Hur som helst, så kan man inte ha något hopp om att säga sanningen om ett ämne, när det är mycket omtvistat — och det är alla frågor som har med kön att göra. Man kan bara visa, hur man själv har kommit att omfatta den åsikt som man omfattar. Man kan bara ge sina åhörare möjligheten att dra sina egna slutsatser samtidigt som de iakttar den talandes begränsning, fördomar och idiosynkrasier. I det här fallet är det troligt att dikten rymmer mer sanning än vad fakta har att ge. Och därför ämnar jag nu med begagnande av all den irret och det självsvald, som tillkommer en romanförfattare, berätta för er historien om de båda dagar, som förflöt innan jag kom hit — om hur jag, dignande under tyngden av det ämne som ni hade lagt på mina axlar, grubblade över det och lät det genomsyra mitt dagliga liv. Jag behöver inte säga att det som jag nu ämnar beskriva inte finns till i verkligheten; Oxbridge är en fri uppfinning; Frenham likaså; "jag" är bara en bekväm

överdriven känslighet
motvilja

oxbridge = oxford
Cambridge

obs!

* inbivir motvilja mot något, utan att egentligen vara varför

ol. av - till grundbesam
x job
sv. kvinnl. romans
RUM
BENSA
blott göra bar
Total
avslo
ingen
SANNING
kan
vara
app
BEROM
ZDGR
FIMMS
EJ I VERK

and
2

350

ISBN

VIKTIGT

benämning på en person, som inte har någon verklighet. Lögner kommer att flöda över mina läppar, men kanske kommer de att vara uppblandade med någon liten sanning; sedan blir det er sak att leta rätt på denna sanning och avgöra, om någon del av den är värd att bevara. Om inte, kommer ni naturligtvis att slänga det hela i papperskorgen och glömma bort alltihop.

*Där satt jag alltså nu (ni kan kalla mig Mary Beton, Mary Seton, Mary Carmichael eller vad namn ni vill — det har inte något att betyda) en vacker oktoberdag för en eller ett par veckor sedan vid stranden av en flod, försjunken i tankar. Det halsjärn jag nyss nämnde, kvinnorna och romanen, behovet av att nå fram till någon slutsats beträffande ett ämne, som väcker allehanda slag av fördomar och lidelser till liv, tyngde mitt huvud till marken. Till höger och vänster glödde buskar av något slag, i gyllengult och högrött, lågande färger, det var som om de hade fattat eld av hetta. På flodens andra strand grät tårpilarna i evig bedrövelse med håret utslaget över axlarna. Floden återspeglade vad den behagade av himlen och bron och de brinnande träden, och när studenten hade paddlat fram sin båt genom spegelbilderna, slöt de sig åter, fullständigt, som om han aldrig hade funnits. Där skulle man ha kunnat sitta medan visaren gick varvet runt, försjunken i tankar. Tanken — för att nu nämna den vid ett stoltare namn än den förtjänade — hade sänkt sin rev i strömmen. Där låg den och drev minut efter minut, hit och dit, bland spegelbilderna och vattenväxterna och lät vattnet lyfta eller sänka flötet, till dess att — det där lilla rycket, ni vet: hur en tanke plötsligt samlas i metrevens ände — och hur man omsorgsfullt halar in den och försiktigt breder ut den? Men ack, hur obetydligt tedde sig inte den här tanken jag hade fått, när den lagts ner i gräset; en fisk av det slag som en god fiskare lägger tillbaka i vattnet, så att den kan växa sig fetare och en dag bli värd att kokas och ätas. Jag skall inte besvara er med den där tanken nu,

BESKRIVNING
PERSONAL
FIKTION
SÄKERHET

slutet
sig
företag
1953
1959 till

den
håller
slaget

Vår och
hög
presentera
alla & v. m.m.

X

V

tyg

-

eld-
igen

godot

edson

sorg

mån

img

hans &

ändock

Poetiske

presenter

häftigt
kast

te sig

- en liten kork som
håller en meter flytande

Se ut
verka
(ter sig)

inte fokusera på kön - man eller kvinna, utan till verkligheten

fortfarande är i livet. Hon lever i er och i mig och i många andra kvinnor, som inte är här i kväll, för de håller på att diska och att hjälpa barnen i säng. Men hon lever; för stora diktare dör inte; de är beständigt närvarande; de behöver bara få sitt tillfälle att i kroppsligt måtto vandra ibland oss. Detta tillfälle tror jag att ni nu får i er makt att skänka henne. För det är min tro att om vi får leva något sekel eller så — jag talar om det gemensamma liv, som är det verkliga livet och inte om de små enskilda liv som vi lever som individer — och får var sina fem hundra pund om året och egna rum; om vi vänjer oss vid friheten och om vi har mod att skriva precis vad vi tänker; om vi slipper ut ur det gemensamma vardagsrummet en liten smula och ser människorna, inte alltid i förhållande till varandra utan i förhållande till verkligheten, och även till himlen och träden och vad det nu kan vara inom dem själva; om vi ser förbi det farliga spöket Milton, för ingen mänsklig varelse skulle få skymma utblicken; om vi ställer oss ansikte mot ansikte med det faktum, för det är ett faktum, att det inte finns någon arm att klänga oss fast vid, utan att vi vandrar ensamma och att vårt samband gäller verklighetens värld och inte bara männens och kvinnornas värld, då kommer tillfället, och den döda diktarinnan, som var syster till Shakespeare, kommer att ikläda sig den kropp, som hon så ofta har fått avkläda sig. Hon kommer att hämta liv av alla de okända liv, som varit hennes förelöpare, liksom hennes bror en gång gjorde före henne, och kommer att födas till världen. Vad beträffar tanken att hon skulle komma utan den förberedelsen, utan den ansträngningen från vår sida, utan det beslutet att när hon föds nästa gång skall hon finna det möjligt att leva och skriva sina dikter, så kan vi inte vänta oss något sådant, för det skulle vara omöjligt. Men jag håller före att hon skulle komma, om vi arbetade för henne, och att ett sådant arbete, även om det sker i fattigdom och obemärkthet, är något som lönar mödan.

Worth working for⁽¹²⁸⁾ en hyllning till den skrivande kvinnan.

ATT INTE KUNNA GREKISKA

— ut vi gemensamheten!

Note: (1929)

Woolf's *A Room of One's Own* consists of two lectures on the subject of women and fiction given at the women's colleges of the University of Cambridge in 1928 and published in 1929. With the help of her narrator, Mary Beton, Woolf approaches her topic of "women and fiction" through a combination of research, anecdotes, imagined histories, and fictionalised encounters. She invites the reader to join her in the analysis of what is clearly a topic that is impossible to sum up.

Reading *A Room of One's Own* articulates structures that often remain invisible. Woolf demonstrates how the freedom to write depends upon material things such as "health and money and the houses we live in"—all the many and often small ways in which creativity requires support: institutional, financial, and intellectual. The imaginary work of fiction, following Woolf, attaches itself to all corners of life like a spider's web. But "these webs are not spun in mid-air by incorporeal creatures. They are the work of suffering human beings and attached to grossly material things."¹

For Woolf, having "a room of one's own" is a way to concretise the freedom to be creative, characterised by the necessity of having enough money and a space in which to do that work.

Note: (2005–06)

Some of the library books I came across in my work had very few underlinings and scribbled words—subtle addendums that became somewhat masked by the multiplicity of voices in the final version. In one copy, belonging to the Umeå public library, someone had circled the word "anger," as it recurs in Woolf's essay at least forty times—and some sixteen times over the course of only a few pages. This is in the second chapter, when Woolf's narrator, in her pursuit of truth, visits the British Museum to find an answer to the question, "Why are some women poor?" Here, she unravels a "world" of literature in which the concept of "human" is equated with "man" and "gender" is understood only as "woman."

In her notebook, Mary Beton compiles the following list:

Condition in Middle Ages of,
Habits in the Fiji Islands of,
Worshipped as goddesses by,
Weaker in moral sense than,
Idealism of,
Greater conscientiousness of,
South Sea Islanders, age of puberty
among,
Attractiveness of,
Offered as sacrifice to,
Small size of brain of,
Profounder sub-consciousness of,
Less hair on the body of,
Mental, moral and physical inferiority of,
Love of children of,
Greater length of life of,
Weaker muscles of,
Strength of affections of,
Vanity of,

Higher education of,
 Shakespeare's opinion of,
 Lord Birkenhead's opinion of,
 Dean Inge's opinion of,
 La Bruyere's opinion of,
 Dr Johnson's opinion of,
 Mr Oscar Browning's opinion of ...

Here our narrator draws her breath, then writes in the margin: "Why does Samuel Butler say, 'Wise men never say what they think of women'? ... Wise men never say anything else apparently."

The authors on her list are "professors, schoolmasters, sociologists, clergymen, novelists, essayists, journalists, men who had no qualification save that they were not women." These men seem to control everything except the fog, Mary concludes, and yet they seem angry with women as the rich are with the poor.

Terrified by the results of her research, she does what Woolf would not: doodles cartwheels and circles on the slips of paper provided by the British taxpayer for other purposes.

Note: The "I" that is the tree that overshadows

While Woolf's narrator recognises that the presumed male "I" of literature is oftentimes respectable, honest, and logical—"as hard as a nut, and polished for centuries by good teaching and good feeding"—its shadow is all too often "shapeless as a mist."

"Is that a tree? No, it is a woman."

The "I" of Woolf's essay is otherwise. It is mainly narrated by Mary Beton, who received her fortune (£500 a year) from a woman (her aunt) who also shares her name. The one is two, standing in for the indefinite: "Call me Mary Beton, Mary Seton, Mary Carmichael or by any name you please—it is not a matter of any importance."

Note: (1858–)

In the second chapter, Mary acknowledges the compromised foundations of her own liberation. Despite having her “five hundred a year and a room with a lock on the door,” she is herself not free from the spider’s web of material connection. She owes her inheritance to imperialism, as her aunt (the one with the same name) fell off a horse and died “when she was riding out to take the air in Bombay.” Under patriarchal rule, Mary seems to think, money is a better alternative to democracy.

Note: (1929–2006)

Through its materiality, my work *A Room of One’s Own / A Thousand Libraries* aspires to ask questions such as: What is a literary text edition? To whom does it belong? Who does it speak to, and who is allowed to speak? It does so alongside the questions posed by Woolf’s essay, among them: “Why are some women poor?” “What effect has poverty on fiction?” “What conditions are necessary for the creation of works of art?” “Why are women [judging from the history of literature] so much more interesting to men than men are to women?” “Women—but are you not sick to death of the word?”

Note: (2003)

In the book *Death of a Discipline*, literary theorist Gayatri Chakravorty Spivak invokes *A Room of One's Own* to put forward urgent questions to the future of "comparative literature" as a discipline: "Can democracy—invariably claimed as a politics, or perhaps the politics of friendship—function without a logofratrocentric [a logic centred in masculinity or masculine exchange] notion of collectivity? With the sister allowed in rarely, and only as an honorary brother?"²

In addition to Woolf's essay itself being based on two lectures, she frames her fictional anecdotes within the setting of the lecture hall. But the lecture as lecture does not begin. "I *would* write this sentence," is where Mary Beton ends the final chapter. She *would* say that "it is fatal for anyone who writes to think of their sex. It is fatal to be a man or woman pure and simple; one must be woman-manly or man-womanly." She *would* say it if she could, but she can't, in the time of the book.

For Woolf, fiction becomes the way to reimagine the figure of the woman as something other than a figuration of the impossible. What happens when the woman is no longer an honorary brother?

Note: (1928)

"Chloe liked Olivia ..."

"Chloe liked Olivia. They shared a laboratory together ..."

"Chloe liked Olivia" ... "although one of them was married and had [...] two small children."

"For if Chloe likes Olivia and Mary Carmichael knows how to express it she will light a torch in that vast chamber where nobody has yet been."

Note: (1564–1616)

As a figure of the unfulfilled creativity of women, Woolf creates a character named Judith Shakespeare—an imaginary sister of William Shakespeare. Judith was just as talented as her brother, with “the tune of words” and “a taste for the theatre.” But because she was a woman, her talent was neither recognised nor permitted to flourish. Woolf’s tale of being a woman and a writer in the sixteenth century is a one in which such a life is “completely and entirely” impossible or destroyed, with Judith Shakespeare’s suicide being the tragicomic conclusion, “buried at some cross-roads where the omnibuses now stop outside the Elephant and Castle.”

Note: (–2006)

In *A Room of One’s Own / A Thousand Libraries*, readers bring their personal reactions and shared experiences in ways that contribute to the text’s (hi)story through making the text into many texts. Just as Woolf’s text is also already many: it is an amalgamation of four essays that resulted in two lectures and told through a narrator and an “I” that is many. “Call me Mary Beton, Mary Seton, Mary Carmichael or by any name you please—it is not a matter of any importance.”

Woolf might appear to be alone in much of the book, but she is in fact surrounded. As we follow the narrator(s) through the essay, we meet women from history, both those who made it as writers in real life and those who have to be imagined. We are surrounded by the women students in the lecture hall in which Woolf frames her fictional anecdotes. As readers, we take part in this collective, and *A Room of One’s Own*, as it turns out, comes to be an essay about women’s collectivity. One’s own room becomes a shared space.

Note:

One of the most underlined sentences of the book reads: "For master-pieces are not single and solitary births; they are the outcome of many years of thinking in common, of thinking by the body of the people, so that the experience of the mass is behind the single voice."

Note: (2020–)

In the book's conclusion, Woolf seems to give up the privilege of the "room of one's own and £500 a year." Here she exhorts the reader to work for the future of women writers and to make possible the realisation of a Judith Shakespeare. As she tells us in the very last line: "I maintain that she would come if we worked for her, and that so to work, even in poverty and obscurity, is worthwhile."

On the opposite page of *A Room of One's Own / A Thousand Libraries* a reader enthusiastically notes: "—Out of the commons!"

1 Virginia Woolf, *A Room of One's Own*, 1929 (Project Gutenberg ebook, last updated April 2020), <http://gutenberg.net.au/ebooks02/0200791.txt>. All quotations from Woolf's book come from this edition.

2 Gayatri Chakravorty Spivak, *Death of a Discipline* (New York: Columbia University Press, 2003), 32.

Image pp. 60–61: Courtesy of Mats Stjernstedt
Images pp. 62–75: Courtesy of the artist

Know-How and No-How:
Stopgap Notes on
“Method” in Visual Art
as Knowledge
Production

5

2008

Sarat Maharaj

This is
an amended
version of
a text that
was first
published in
*Malmö Art
Academy
Yearbook
2007–2008*
and in *Geist*
11, 12 and 14
(Stockholm,
2007–2008).
Republished
by permission
of the author.

These jottings touch on five elements of method that I should like to relate to art practice and research. Two are sketched below, followed by four truncated entries for future elaboration: “The Disputation at Lund, 15/09/06,” “Confucius Lab,” “Uddevalla, Volvo, 1989–93,” and “Nameless Science or the Unnameable?”

Mulling Over Method

(1) The query that crops up right away with the idea of “visual art as knowledge production” is: What sort of knowledge? Hard on its heels: What marks out its difference, its otherness? Should we not rather speak of *non-knowledge*—activity that is neither hard-nosed know-how

nor its ostensible opposite, ignorance? The question is especially pertinent in today’s expanding knowledge economy that we should not only see as a “technological development” but as an emerging overall condition of living that I prefer to speak of as the “grey-matter” environs.

(2) “Visual Art as Knowledge Production” involves sundry epistemic engines and contraptions that we might broadly refer to as “Thinking Through the Visual.” What do such modes of knowing entail? How do they tick?

With (1) above, we can get bogged down fairly quickly with the daunting notion that nothing counts unless it has the systematic

rigour of “science.” This might be an unavoidable, bracing test-demand of today’s knowledge scene. However, it should not blind us to the fact that what we lump together as “science” is often a congeries of quite divergent activities, disciplines, and domains, each with its own kit of objectives and logical procedures. We should be wary of treating them as if they added up to a monstrous monolith. In any event, many scientists themselves remain more than a pinch circumspect of philosophical attempts to sum up their activities with a single overarching methodological principle. We might do better to keep matters open, perhaps with a feel for the hodgepodge of methods, even muddle, that attends the lab workbench. Though Gaston Bachelard’s musings might in parts sound a touch dated, his view of “science” as a plurality of practices in which “each secretes its own epistemology” — each, arguably, with its own “degree of approximation to truth” — serves as an antidote to a solo, make or break, subsuming principle of knowledge, truth, and method (*Le Nouvel esprit scientifique*, 1934). His account resonates with the state of play in art practice and research that also amounts to a proliferation of self-shaping probes, stand-alone enquiries, motley see-think-know modes. Their sheer heterogeneous spill tends to stump and stonewall generalisable principles — at any rate, they resist being wholly taken

under the wing of systematic methodological explication.

Two examples flesh out the point: Marcel Duchamp spent years devising a lingo, with rules, anti-rules, and measures, mingled in with doses of quirk, chance, and random intrusion for his *Large Glass* project (1915–21). Sometimes they appear to strive towards formulation as abstract principles of method — as “algebraic expression” in his phrase — that can be applied at large. At other moments they hunker down to one-off use — with relevance only to a particular, unique, intensive instance. There is a billowing out towards the global scope of “method proper” countered by retraction to the modestly local, here and now. Duchamp damped down wider claims for his methods by noting that they were “probably only applicable to individual works” such as his own *Large Glass*. With *The Passage from Virgin to Bride*, we feel a process of becoming — emergence from brooding states of possibility — towards a kit of disposable rules of engagement that seem poised to dissolve back into a pervasive, unpredictable, creative muddle. In contrast to Duchamp’s conceptual domain, the second example is from the retinal field: David Hockney’s look at regimes of seeing, *Secret Knowledge* (1990) — a project that might be seen as “art research” *avant la lettre*. He rubs up his examination of retinal-optical schemas and their

underlying structural principles against his keen observations of how they are often modified and moulded by the artist's eccentric eye or touch. We glean that the drive to render, regulate, and represent perceptual experience on the back of methodological formulae is constantly amended by the artist's handling, by embodied knowledge.

What comes into spotlight with these two somewhat iconic examples—the sample could be expanded to take in Mario Navarro, Seydou Boro, Tamar Guimarães, Thomas Hirschhorn, Lu Jie, Huang Xiaopeng, amongst others—is the point that method is perhaps less about given, handed-down procedures than about approaches that have to be thrashed out, forged again and again on the spot, impromptu in the course of the art practice-research effort. I am left pondering the idea that method is not so much ready-made and received as “knocked together for the nonce”—something that has to be invented each time with each research endeavour.

Any Space Whatever

With the above we have what looks like a roller coaster between the methodological pole of “universal application” and that of the rule of thumb restricted to the “particular.” How to portray something of this oscillation in theoretical terms? Deleuze came to explore the sense of an unfolding flux between the

“poles” in all its phases and variability through the notion of “any space whatever”—drawing on a series of examples from film (GD, *Cinema 1* and *2*). In his critique, “any space whatever” takes on the force of method: it embodies the concept of “singularity” that cuts across the poles of the universal and the particular dissolving them. A strand in the backstory of this notion, as we might deduce from his reference to Bachelard, seems to lie with Ferdinand Gonseth who had tussled with the “any space whatever” in mathematics, with rules that undergo change, with process and contingency. In the framework of a non-Aristotelian logic, Bachelard had used the term for an alternative tack to the Kantian principle of the “universal”—also, to bridge the gap between thinking either in a priori or a posteriori terms, in empirical or in rationalist key (GB. “La philosophie du non,” 1940).

For our purposes, it is Giorgio Agamben's “whatever” that will have to do as a more digestible, more spelled-out version of a methodological alternative to the “universal/particular” polarity—to what can be slotted neither into the category of the “individual” nor into the “generic” without grievous distortion. He broaches it as modal oscillation illustrated by the example of the human face. Its constantly changing liveliness, its vivacity, he notes, embodies a singularity that

is neither an individual manifestation of a “general pre-existing facial template” nor a “universalisation” of the unique traits of one specific face. Perhaps not unlike an ever morphing ripple between the extremes of “all faces in a crowd” and “just this one” in front of us? He goes on:

In the line of writing the ductus of the hand passes continually from the common form of the letters to the particular marks that identify its singular presence, and no one, even using the scrupulous rigour of graphology, could ever trace the real division between these two spheres. So too in a face, human nature continually passes into existence and it is precisely this incessant emergence that constitutes its expressivity. But would it be equally plausible to say the opposite: It is from the hundred idiosyncrasies that characterize my way of writing the letter p or of pronouncing its phoneme that its common form is engendered. Common and proper, genus and individual are only the two slopes dropping down from either side of the watershed of whatever. (GA, *The Coming Community*, 1993)

His sum up can sound a trifle pat, even reductive. He evokes something elusive graphically only to nail it down all too firmly as a principle.

Deleuze, on the other hand, teases out, frame by frame, the diverse ways in which “whatever singularity” comes to be embodied in specific scenes—a diverse sequence of examples that cannot be fixed into a rule that has “universal” coverage. Agamben highlights the tricky methodological poser we cannot easily shake off—that by opting to treat art practice and research either entirely under the universal or the particular, either exclusively on the immanent or transcendental plane, we miss out on reckoning with its intrinsic condition, its “singularity.”

With (2) above, we have to clock both senses of the phrase “Thinking Through the Visual” in order to latch onto its import for method. It is not only about thinking by means of the visual, via its sticky thick, as it were. It is about unpacking it, taking apart its components, scouring its operations. A point that crops up at this juncture is what makes the texture of visual art thinking quite its own, its difference? What is its distinctive thrust in contrast to other disciplines at the more academic end of the spectrum—to forms of enquiry tied up with, say, mainstream anthropology, sociology, literary, and communication studies or historiography? Does it spawn “other” kinds of knowledge they cannot—what I’ve elsewhere called “xeno-epistemics”? How to sound this obscure surge without treating it as an “unchanging essence of art practice”? What I am trying to

finger eventuates not so much in the well-trodden terrain of the academic disciplines or in the so-called gaps, chinks, and cracks between them or in any designated “interdisciplinary-transdisciplinary” belt. Rather it is a force in its own right, always incipient in “whatever” spaces—windswept, derelict brownfields and wastelands—where intimations of unknown elements, thinking probes, spasms of non-knowledge emerge and come into play. It is distinct from the circuits of *know-how* that run on clearly spelled-out methodological steel tracks. It is rather the unpredictable surge and ebb of potentialities and propensities—the flux of *no-how*. The term is Samuel Beckett’s although I intend it here without that shot of bleakness with which he normally imbues it. “No-how” embodies indeterminacy, an “any space whatever” that brews up, spreads, inspissates (SM, “An Unknown Object in 4D: Scenes of Art Research,” 2003).

This is not to say that visual art practices do not interact with established discursive-academic circuits and think-know components. They do so vigorously—glossing and translating them, aping them with bouts of piss-take, subjecting them to *détournement*. However, this should not lull us into seeing the discursive as the only or the prime modality of “Thinking Through the Visual.” Alongside, runs its intensive non-discursive register, its seething para-discursive

charge and capability—both its “pathic” and “phatic” force, its penumbra of the non-verbal, its somatic scope, its smoky atmospherics, its performative range.

For method, the job is to draw a vital distinction between “thinking through the visual” and the somewhat crimped mode of “visual thinking.” By the latter, I mean those approaches to the visual that treat it predominantly as an “image-lingo”—basing it on a linguistic model ostensibly with codes of grammar, syntax, and related regularities. The rise of this view accompanies strands of Conceptual Art—also, the poststructuralist-semiological dispensation where “reading and telling” the visual is styled as an almost full-blown linguistic and “literacy” enterprise. Its impact is to restrict the visual to verbal-discursive legibility—a linguistic turn and dexterity exemplified by Jacques Lacan’s pronouncement that “the unconscious is structured like a language.” In this perspective, “talking over the visual”—in the sense of mulling it over—literally turns into “talking over and above it.”

Agglutinatives

“Thinking Through the Visual”
—at odds with “visual thinking”
—is about what we may dub the “agglutinative mode”:

(i) To speak of it both as “liquid, wordless syntax” and as the “grammarless zone” of unknown

possibility sounds a bit double-tongued. But the mode is shot through with contraries. Its principal thrust is decisively beyond the organising, classifying spirit of grammar, beyond the divisions and discontinuities associated with the way regular lingo cuts up and shapes thought and expression. Henri Bergson saw such categories—verbs, substantives, adverbs—as brittle, arbitrary functions of the intellect-analytic. They rendered the ever changing flow of time, experience, and consciousness in terms of static representations, stills, and freeze shots. He likened this to the “cinematographical mechanisms of thought”—to cut-and-paste techniques that conjured up the illusion of movement instead of immersing us in duration, flow, and change—in the “streamsbecoming.” Duchamp and Deleuze sought to articulate such passages of transition and transformation—precisely by a “turned around” use of film stuff that Bergson had railed against (SM, “Fatal Natalities,” 1997). In articulating the “streamsbecoming,” the agglutinative brings into play associative manoeuvres, juxtaposition, blend and splice, non-inflexional modes of elision and stickiness. We have a dramatic contrast by setting it off against parsing—a function that epitomises the “slice and carve” mechanism of grammar. It is about chopping up flows of information, experience, and thought into combinatory

bits, modules, units, and packets to configure them into algorithmic sequences—into the computational mode. It stands at the opposite end of the spectrum to the agglutinative’s “stick on” processes of figuring forth, of constellating assemblages. Whether this puts it entirely outside the ambit of grammar remains arguable. More likely we are faced with an agrammaticality that has the capacity to oscillate rapidly between several modalities. In this sense, it is at odds with the computational constancy and equilibrium of *know-how* and closer to the all-over smears, surges, and spasms, the unpredictable swell and dip of *no-how*.

The Wiring Diagram: 01/10/1974

John Hoskyns spent ages perfecting his diagram of factors and protagonists in the sorry saga of the mid-1970s British economy (JH, *Just in Time*, 2007) an arresting piece of visual thinking, it reminded Mrs. Thatcher of a “chemical plant.” At first sight, it seems a jumble of pathways, routes, cul-de-sacs. But as we pore over the carefully plotted circuits and linkages, we become aware of the array of social forces and institutional relations teetering on the brink. In the larger sweep of historical events, it is perhaps a miniscule, if sparking, footnote to Mrs. T.’s tough remedy for the “sick man of Europe”—a cure that involved “rolling back state bureaucracy,” halting creeping socialist control, and a “long march” to

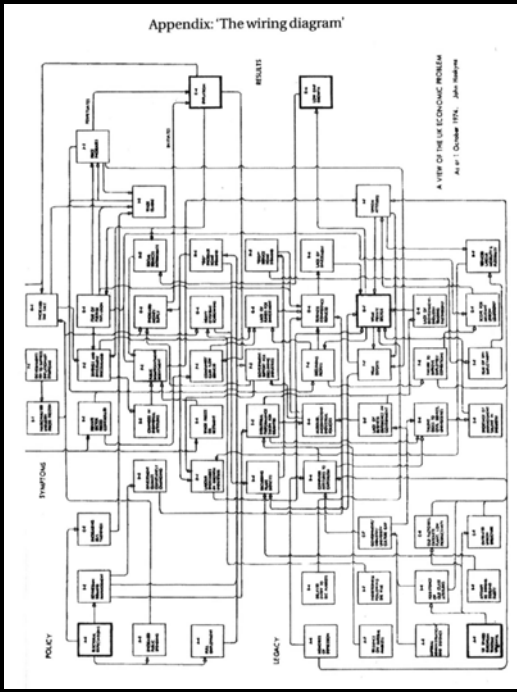

The Wiring Diagram.
John Hoskyns.
October 1, 1974,
in *Just in Time*.
Inside the Thatcher Revolution.
Aurum Press, 2000

the free-market economy. Systems theory, cause and effect relations, feedback loops shape Hoskyns's visual exposition. The various positions have a sense of reversibility, an air of linear-causal rationale. The impression we have is of a set of relations that can be rerun with much the same result each time—or with little leeway for difference of outcome, for detour and digression. It lends a stamp of reliability, consistency, and coherence as would be expected of a considered socio-economic statement. This is at odds with how we might understand repetition in art practice

and research where such a degree of "exact repeatability" would be looked upon not only as unlikely but undesirable, where each rerun would spawn unique, one-off variants—where repetition amounts to unpredictable generation of divergence and difference.

(ii) Whether we take the Ezra Pound–Marshall McLuhan exchange on the copula of dialectical thinking pitted against agglutination (EP/McL, *The Interior Landscape*, 1969), or James Joyce's sticky lingo in *Finnegans Wake* or Derrida's reading of Jean Genet against Hegel (JD, *Glas*, 1989), or

Michel Foucault’s unpacking of the “Western episteme”—we have probes galore looking for an escape hatch from the closures of dialectical thinking in which Hegel is usually billed as the bugbear. The point here is whether the agglutinative offers a less overbearing logical structure and is less of a “no-exit” contraption than its dialectical counterpart. The complaint against the latter is that from its opening gambit, its proposition already contains the outcome—“foreclosing” engagement with radical difference. It leaves no room for the “other” to put in an appearance in his or her own terms.

We are presented with a thesis which already prefigures and tailors the antithesis of the “other”—groomed for “cancellation and carry over,” for “*Aufhebung*” onto a “higher” plane. From the word go, the “self” who makes the proposition calls the tune in constructing the “other”—a view of dialectical procedure that comes in for heightened criticism under post-Marxist, postcolonial eyes today. Deleuze relates the agglutinative to a loose, open-ended logical structure-in-progress. Its components are linked together by no more than a lick of glue—threaded together with no more than the humble

The Disputation at Lund.
September 15, 2006.
Drawing by Cedric Bomford

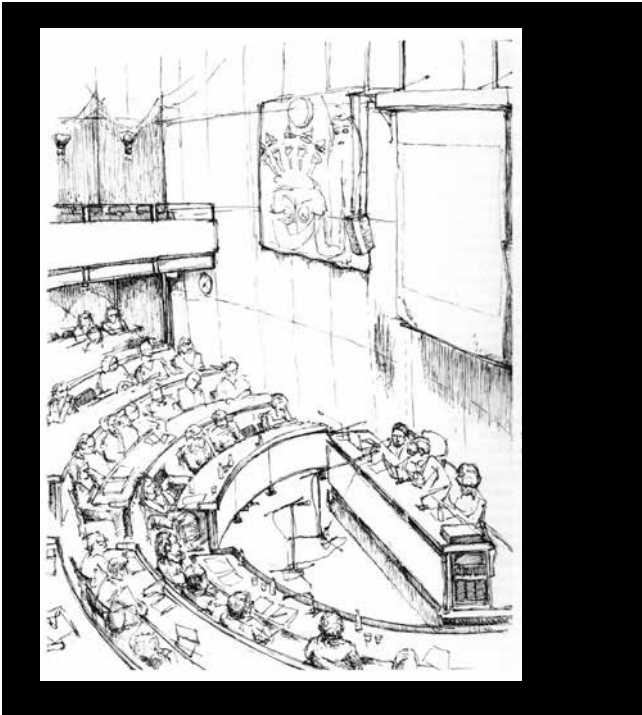

conjunctive form “and+ and+ and+ ...” Elements join up in an *add on ad infinitum* scenario at odds with the assimilative force unleashed by dialectical relations. The sort of non-assimilative threading is not unlike a “list that can be added onto interminably” that is Feyerabend’s riposte to the streak of control freakery in dialectical thinking. It is not surprising that he and Deleuze cite Kurt Schwitters’s Merz assemblages as models of non-dialectical method, seeing in his art practice a kind of Dada epistemics—a shuttle between Muddle-Method-Madness—an opening to otherness and difference that cannot be known in advance (SM, “Monkeydoodle,” 1997, and “Merz-Thinking: 50 years of documenta,” 2006).

Method Fever

The preceding issues of method are largely in a theoretical vein. Below are notes on (i) and (ii) institutional (iii) economic (iv) historical factors that have a bearing on the story.

(i) The Disputation at Lund, 15/09/06

The first PhDs in visual arts practice “under Bologna” were assessed (Lund Stadshal & Konsthal. 2005) by an international panel of examiners chaired by Gertrud Sandqvist and Håkan Lundström, Malmö Art Academy, Lund University. The three doctoral submissions were by Sopawan Boonimitra, Matts Leiderstam, and

Miya Yoshida. The event marked a substantial advance in formal visual art education. Not least, it signals the growing institutional location of visual art practice and research in the university sphere. In the UK, where these developments are further down the road, we see the emergence of a full-blown art practice–research system with a corpus of methods and procedures—identifiable, validated, and testable; that is increasingly the *sine qua non*. The Research Assessment Exercise (RAE), the meta-review of research criteria (*Roberts Report*), journals, publications, and conferences further attest to investments in art method as an “emerging arena of practice and research” and its “academic legitimating.” A comprehensive midway reflection on these developments (“History of the Human Sciences: Knowledge for What?,” 1999) concluded that some tendencies have proved positive and fruitful, others remain cause for concern—above all, the prospect of an administered, highly managed “ideology of creativity.” The plethora of “Departments of Creativity and Innovation”—especially at the intersection of New Media, Art, Design, and Science—signal both contemporary anxieties over “creativity” and new mappings of the terrain. It also heralds the phenomenon of the “methodologisation process” generally understood in somewhat instrumental fashion as a kit of know-how

procedures and techniques. The frenzy over method is perhaps not dissimilar to the moment in the “onwards march of method” in philosophy of science in the heyday of Karl Popper. It provoked Feyerabend’s “Anti-Method” — a call to resist “methodologisation” by taking heart from both an original scepticism and “creative muddle” that attends scientific experiment and art practice. The call resonates with an earlier moment in the history of the English art school when it was to some extent regarded a site of “unschoolability” — where one stumbled over unknown possibilities, over “no-how,” rather than trained in the know-how of a practitioner “in the method school of acting” (SM, “Vienna,” 2001).

(ii) Confucius Lab

Why knowledge “production”? The question crops up again as we see “method fever” intensifying the drive towards institutionalisation of art research and practice: with this goes a heightened academicisation not in the sense of enhanced analytical rigour but of regulation and routine. Why speak of “production” when it smacks of factories, surpassed industrial modes, heavy-metal sites and plants, the assembly line’s mechanical regime — standardising components at odds with the vagaries of art practice? The usage is to help distinguish it sharply from the domain of



Bo Shi Hall. Sarat Maharaj. Beijing, 2008

“knowledge transfer.” The latter chugs on primarily with acts of transmission. It is about shifting already made bodies of thought and data, about handling and filtering existing information. The emphasis is on both reproducing data and passing it on, a DNA Xerox process — the logic of replication.

“Production,” on the other hand, centres on a transformative crossover that throws up a surplus, that churns out something more than what was there to begin with. In this sense, it harbours the possibility of spawning something “other” than what already exists—the logic of invention and innovation. It is about generating data, new objects and ways of knowing. “Transfer” presides over a defined territory, ultimately the canonical corpus. The concern is with mastering and mining an already identified field with fixed procedures and protocol, with formal induction and training. The epitome of this drive is perhaps the antique “closed circuit” of the Confucius exam system. Its function was to ensure replication of scholarly knowledge and bureaucratic know-how—the maintenance of a sense of stasis, of perpetual equilibrium. It marks a scene of learning that essentially unfolds within a frame of rules to ensure carry over and continuity. In contrast, with “production” there is leeway to this regulative force, the possibility of divagation, of divergence and disequilibrium over a period of time that makes vital room for the appearance of something different or unforeseen. In this sense, the scene of learning becomes like a “lab without protocol”.

The lab has featured widely in recent years as a model for what the contemporary Art Academy might look like. The idea gained further

currency with the *Laboratorium* exhibition (Provinciaal Fotografie Museum, Antwerp, 1999) that implicitly probed and unpacked traditional models of the Academy—Studio and Atelier. The “Lab” model gave impetus to mapping new, emerging relations between work, labour, creativity, and scientific-technological practices—interactions increasingly shaping the structures of contemporary production and living. It tended to show up the Academy” more as a “self-organising space” than as the transmission belt of “knowledge transfer” based on the authority of the master practitioner. This tilt becomes pronounced with “outsourcing”—practitioners plugging into high-tech know-how beyond the Academy walls for the construction and execution of their work. It put into question the Lab model itself—the older view of the Academy as the self-sufficient Panepistemon. Today, the “Academy” is seen not as the fixed site, Know-All Centre but as a straggle of self-organising educative-creative events and conjunctures, each springing up afresh from scratch, as it were, for whatever art research project. The Academy becomes less a monolith establishment, more a series of micro-labs or nano-labs, that take shape within a band of knowledge practices—within the modalities of the haptic, retinal, computational, the frequencies of sonic grime, the somatic, performative, digital, amongst others. Each

time an art or research programme is floated, we might say, a micro-lab has to be knocked together for the occasion. Like kludges or Heath Robinson contraptions, they have to be patched together for the occasion with whatever is at hand—what we might call “a lab for the nonce”.

(iii) Uddevalla, Volvo, 1989–93

As the “conditions of creativity” undergo change today, they have increasing bearing on what we consider as “work”—how we define labour, knowledge, creativity, and art practice. Method and technique feature heavily in this shifting scene. The Volvo factory at Uddevalla, Sweden, was tailor-made for one of the most advanced experiments in work, method, and creativity in terms of the post-Ford model of production. The deep distinctions in older industrial production between workforce and planners, brawn and brain, makers and thinkers came in for remapping at Uddevalla and its counterparts in other parts of the advanced capitalist world—a development coinciding with the *sine qua non* of information technology. Stationed in special work bays, workers were equipped to plan and direct the whole project, with emphasis on feeding new ideas into production—tapping into the workers’ “creativity and imagination.” From the image of the worker as an alienated, automaton-operative we move to that of the knowledge-concept engineer, whose store

of brainwork, inventive and creative capacities becomes the linchpin of production in the “immaterial labour” of the knowledge economy. We might see a rough but suggestive parallel between this development and the notion Duchamp had toyed with—the idea of a “grey matter, cortex-based” art. He conceived of this partly to weed out the somewhat lowly “physical” status of art knowledge and creativity encapsulated in the phrase “as stupid as a painter.” What would be the shape of an intelligent-conceptual-cortical art practice remains an open issue in contemporary art. However, there is not a little irony in the fact that the “work-creativity embrace” in today’s “grey matter” environs is not dissimilar to what he seems to have had in mind. It marks a further step down the road of what we might call the “corticalisation of creativity”—tending towards the pole of dexterous, “ether-real” permutations in the algorithmic mode. The tendency marks the rendering of creativity increasingly as hard-nosed *know-how*—a drift that makes it even more crucial to keep the door open for the unpredictable see-feel-think processes of *no-how*.

(iv) Nameless Science or the Unnameable?

When I mentioned Agamben’s account of Aby Warburg’s “Nameless Science” almost in the same breath as Samuel Beckett’s

Lab	Know-How & No How Knack	
Nano Richard Feynman	micron	Angstrom Lens
Noumenal Gaston Bachelard	Cortex Cap	Arithmetization of Reality Chalkboard
Digital Virtual		Keyboard Mouse
Visceral Haptic	sweatshop fabricator	needle Screen
Post-disciplinary Peter Galison	creolizing corridors	Water cooler oasis
Retinal	Life Room	DVD TV Audio Video
Ezra Pound Louis Agassiz	Slides light box	iPhone PowerPoint
	OUTSOURCING	

Know How, No How & Knack.
Sarat Maharaj, 2008

Unnamable (SM, “An Unknown Object in 4D,” 2003), my aim was to highlight a factor that has come to loom large today—the tendency towards the institutional captivity of art research, the academisation of “thinking through the visual.” I tend to see this as an intrinsic effect of philosophical explication on experimental-embodied practices such as Warburg’s—that it renders what we call the “Nameless Science” in danger of being named explicitly and being tagged with an all too determinate identity, perhaps no more than a step away from setting

it up as a recognisable, academic terrain with disciplinary borders. This has little to do with Agamben’s analysis as such—which happens to be a nuanced, suggestive piece—but the drive in theoretical exposition to make transparent the “rationale” behind Warburg’s “chaotic, impromptu think-feel-know sorties,” to lay them out in a clear-cut way as a methodological kit. The threat of codifying his approach has shadowed his work all along from the time the Warburg Library-in-Exile of the 1930s underwent incorporation by the late 1940s into an “institute”

of the University of London. The demand to nail the unnameable covers several dimensions of his work: the pressure to identify the logic behind “thinking through the visual,” behind elements of “xeno-epistemics” in his yearning to reconnect with the “other worlds” of the Pueblo and Hopi, behind the Dada epistemics of his “critique of unreason” of his *Bildatlas*. The demand to iron these out tended to be in the interests of placing the “Nameless Science” in the order of university disciplines, in the formation of the History of Art as a proper field of study with know-how credentials. His

apparently topsy-turvy think-feel-know contraptions perhaps truly took refuge with artists—with practices such as Kitaj and Eduardo Paolozzi in their disjunctive collage modes (R.B. Kitaj, *Pictures with Commentary, Pictures without Commentary*, 1963). These seemed to spring at the outskirts of regulated readings of Warburg’s visual investigations. At odds with the “institutional drive”—one that can easily repeat itself in the art research world after the “Disputation at Lund”—we have Samuel Beckett’s *Unnameable*, crucially signposting the creative murk, the unforeseeable drifts of *no-how*.

Ronald B. Kitaj,
Warburg as Maenad,
oil and collage on
canvas, 1961–1962.
Courtesy of Estate
of Ronald Kitaj
and Kunstpalast,
Düsseldorf.



Suspended Stories: Rosa Barba's Strategic Narrativity

6

Lynne Cooke

2011

This text was first published in *Rosa Barba: White Is an Image* (Ostfildern, Germany: Hatje Cantz, 2011) and was written in relation to the exhibition *A Curated Conference: On the Future of Collective Strength within an Archive*, at the Museo Nacional Centro de Arte Reina Sofía in Madrid in 2010, which

was the result of an invitation from Lynne Cooke, then deputy director and chief curator at the Museo Reina Sofía, to artist Rosa Barba to engage with the museum's archives and collections. Barba earned a PhD from Malmö Art Academy in 2018. Reprinted by permission of the author and Rosa Barba.

"How can visual works of art ... tell stories? ... Narrative [must] become a tool not a meaning; a mediator not a solution; a participant not an outsider."

—Louise Bourgeois

"A philosophy is characterized more by the formulation of its problems than by its solution of them."

—Suzanne Langer

Rosa Barba's *Somnium* (2011), a 35 mm film projection that runs just over nineteen minutes and twenty seconds, draws together many of the key concerns that have emerged in the artist's oeuvre over the past decade. Its point of departure is a short novel by the German astronomer Johannes Kepler.¹ Although framed as a dream, this tale of

a lunar voyage was devised to validate the radically seditious thesis of a heliocentric universe.² For over thirty years, Kepler worked on his contentious theory, writing in Latin rather than the more accessible vernacular in the hope of warding off attacks from those who still believed that the earth was located at the centre of the universe. Published

posthumously in 1634 and only rarely reprinted over the next three centuries, the text was finally rescued from obscurity when translated into several European languages. Soon gaining an underground reputation among devotees of science fiction, today it is widely recognised as a pioneer in that genre. While writers such as J.G. Ballard have drawn profitably from it, filmmakers have not yet succeeded in giving it cinematic form. Extensive research into *Somnium's* checkered history informed Barba's eponymous project. Borrowing Kepler's title in tribute, she has drawn upon both his tale and, equally importantly, his remarkable achievement in establishing a new ontology of vision.

One of the singular features of Kepler's novella is its curious structure. The story, such as it is, breaks off abruptly when the narrator suddenly awakens from his lunar voyage and finds himself in his bed, his head muffled under his pillow. Recourse to the device of a dream is a blatant ruse that does little to mask the incendiary argument, the substance of which may be found in the extensive footnotes and commentaries that threaten to overwhelm the brief tale. Filled with scientific data and hypotheses, these appendices sometimes ground, and sometimes contest, the empirical observations and classical references proffered in the main body of the text. At the heart of Kepler's thesis is the conviction that rational scientific hypotheses can lead to theoretical truths neither

accessible to, nor necessarily verifiable by, pragmatic observational study. Prescient recognition of the limitations of direct observation and empirical enquiry led him to posit an ontology of vision based in scientific theory.

A debate couched in similar terms is woven into Barba's work. Her film opens with the voice-over of an authoritative male speaker who dispassionately relays the information that, though the planet *Somnium* is currently devoid of all living forms, nature is in the process of reclaiming areas that until recently had been given over to human enterprises. A classic science fiction beginning, this opening gambit promises the security of a grand narrative yet quickly destabilises expectation by introducing a variety of narrative modes that undermine notions of authorial omnipotence and coherence. Suturing documentary material to fictional narrative, and interleaving dissenting eyewitness accounts with the reports of officialdom, she counterpoints the evidentiary with the theoretical. A second voice is then heard. Colloquial in tone as well as address, it rarely rises above a fearful whisper as it relays its suspicions that something is deeply wrong with the information being distributed publicly about the sweeping changes transforming the environment. Unlike Kepler's knowing narrator, Barba's unassuming if sceptical witness seems unaware of the polemical import of his observations. Ultimately, the artist's film avoids

adjudicating between contrary perspectives, ending provocatively with a quotation from the Renaissance mystic Giordano Bruno, who argued that “the observer is always at the center of things.”

Subtle shifts within and among narrative voices in *Somnium* complement Barba’s handling of the compelling visual imagery. Black-and-white photographs are reproduced of what can be assumed, due to cross-cutting between still and moving imagery, to be documents of the site in an earlier era. At other moments slow pans interrupt still shots that frame such details as a waste pipe cantilevered over an incline. Several images of this kind directly recall motifs that Robert Smithson highlighted in his landmark text “A Tour of the Monuments of Passaic, New Jersey,” published in *Artforum* in December 1967. There Smithson reprises a trope of landscape art, transposing a canonical journey through a picturesque, bucolic location to the dystopian industrial wastelands of a New Jersey backwater. Beguiled by such ruins, which, for him, could be best read as monuments to mankind’s failed visions for a utopian technological future, Smithson returned repeatedly to this subject, above all in the great trio of works—sculpture, film, and essay—yoked under the collective title *Spiral Jetty* (1970–72). *Somnium* clearly alludes to Smithson’s seminal film, and not least to its hybrid wedding of first-person narrative to quotations and citations from science fiction,

travel writing, literature, and science manuals in order to conflate disparate temporalities—past, present, and future—in cyclical, linear, and entropic timescales. The subtext of mnemonic images and references generated by Smithson’s works is as central to any reading of *Somnium* as the film’s debt to Kepler’s literary gem. Barba’s project newly animates these precedents. Far from being mired in a historical past, these works, she contends, embody ahistorical voices; they are crucial components of a critical discourse that seeks to define the kind of vision required by a politically engaged contemporary cinema.

A more melancholy tone inflects *The Long Road* (2010), which, like *They Shine* (2007) and *The Waiting Grounds* (2007), was shot in the American Southwest. Seen initially from the air in a long tracking shot, the abandoned automobile test site that is the work’s visual focus resembles a prehistoric earthwork or a 1970s variant on the genre. Whether kin to the ancient Nazca Lines in Peru, only rediscovered as a result of air travel, or to the industrial-scale incursions Smithson and his peers made into remote desert terrain in the postwar years, this elliptical incision in the earth’s surface is similarly subject to decay and the predations of time. The soundtrack mingles techno-electronic sounds, from which haunting microtonal phrases emerge intermittently, with the throaty voice of Robert Creeley reading from his poem “The Long Road.”





Images pp. 102–103:

Rosa Barba, *Somnium*, 2011. 16mm film transferred to video, color, sound; 19:20 min. Video stills. Courtesy of the artist

Images pp. 104–105:

A Curated Conference. Exhibition view at Museo Nacional Centro de Arte Reina Sofia, Madrid, Spain, 2010. Courtesy of Rosa Barba. Image courtesy of Joaquín Cortés / Román Lores





Memory of his father's death, coupled with a recognition, prompted by the sight of old school photographs, of the many decades that have elapsed since his passing, reminds the poet of his own mortality. The implication that the end of his long road may be approaching is picked up in the final shot of the film. Now positioned at ground level, the camera circles the test track; after rounding a curve, it enters a straight stretch, down which it speeds into the late-afternoon sun. Barba imbricates these shifting vantage points of eye and voice through her editing and pacing of the camera movements and her positioning and framing of the text within the audio track. As in *Somnium*, a mnemonic function based on direct and indirect reference to the works of other artists (a poet and nameless sculptors, in this case) is integral to the way content is elaborated.

Barba's engagement with the place and role of works of art within the broader cultural imaginary was further clarified in her response to a recent commission from the Museo Nacional Centro de Arte Reina Sofia in Madrid. Invited to curate an exhibition from the museum's holdings, she responded with a proposal that she called "a curated conference." Her project comprised a presentation of some forty-three works, including film and video, photography, sculpture, painting, and drawings, which she installed in two adjacent galleries. "It is the aim of this conference to draw

together a representation of artists from the twentieth and twenty-first centuries, and bring their informed opinions to bear on the significant questions of art," she wrote in the accompanying brochure.³ Titled *On the Future of Collective Strength within an Archive* (2010), her display eschewed standard conventions of museological presentation, notably the segregation of art forms by medium and a linear hang arranged chronologically, in favour of an installation that juxtaposed and overlaid pieces made over the span of almost a century in close proximity. Rather than suppressing difference in service to an ideological imperative—the basis on which most collection displays are presented in contemporary art institutions today—she welcomed the anarchic outcome produced by a situation in which "each artist speaks with their own voice in their own language, temperament and volume." Recognising that although some were recent additions, many of these artworks had long been in the collection, she invited the artists (through their works) to explore the "collective consciousness" within the archive. What would emerge, she anticipated, would be neither a consensual nor a coherent vision (the goal of museum professionals), but a "Babel of voices": the archive would be shown to be composed of "dateless individual expressions" that can be "choreographed like a musical score." "By negating the past and ignoring the future the artist can be free to make a radical

statement which lasts over time ... [and generates] an energy which connects artists of all ages," she contended.

Round-table discussions, workshops, a parallel session, and keynote speeches by Pablo Picasso, Mira Schendel, Louise Bourgeois, Martha Rosler, and others were also planned as part of the programme. Several speakers brought up concerns adumbrated in Barba's own practice. Thus Picasso, for example, claimed, "All I have ever made was made for the present and with the hope that it will always remain in the present." In the abstract of his speech, George Maciunas underlined Barba's sense of collective identity when he termed this "community of individuals grouping together a vast quantity of behaviors and attitudes ... a 'non-group' with no strict structures." Bourgeois, for her part, addressed the ways that visual works of art tell stories: through the interplay of formal qualities, "narrative becomes a tool not a meaning, a mediator not a solution," she argued. Although Barba omitted her own works, and hence her own voice, from the actual discussion, she made her position vividly clear by choosing as her principal speakers artists whose aesthetic and work instantiate the key terms in her own practice.

The archive was literally the source of Barba's exhibition-as-conference, given that the checklist of works on view was drawn exclusively from the museum's holdings, notably works from its storage. The

term "archive," in addition to its familiar usage as a corpus or collection of data, may also be used more abstractly to refer to the system that, in Hal Foster's words, "structures the particular expressions of a particular period."⁴ This discursive notion of the archive was brought into play in Barba's project in that she critically engaged the ideology governing the presentation of the institution's collection elsewhere in its facilities, offering a subversive alternative to its norms of representational totality and historical accountability. That is, given her belief that artworks are "ahistorical" or "timeless," they can be self-organising and come together through their creators' initiative, rather than depending on museum professionals who subsume them to disciplinary ends.

Barba's innovative project can also be read through the model of the museum that Theodor W. Adorno addressed in an essay published in 1953 on what he called the "Valéry Proust Museum."⁵ According to Adorno, the poet Paul Valéry espoused the position that the museum is "where we put the art of the past to death." "Museum and mausoleum are connected by more than phonetic association," he contended, for "museums are like the family sepulchers of works of art. They testify to the neutralization of culture." In opposition to the embalming, or reification, of the artwork that Valéry believed took place in the museum, the novelist Marcel Proust articulated a vision based on

the idea of the artwork's reanimation. The museum is consequently for him a site of agonistic competition. Echoes of Proust's ideas may be heard in Barba's curatorial conference. However, whereas Proust accorded agency to the spectator, who was charged with reanimating the work, Barba tellingly leaves control in the hands of artists: their works embody their voices.

The Hidden Conference: About the Discontinuous History of Things We See and Don't See (2011), a 35 mm film shot shortly after Barba launched her project at the Museo Reina Sofia, explores this debate further.⁶ Set in an unidentified location (the storage area of the Neue Nationalgalerie in Berlin) and at "an unspecified point in time (in the future or in the past)," it brings to light a situation that, although existing for years, the written prologue informs us, has now taken on a certain "degree of urgency." Nonetheless, the reason for the meeting is no longer known. As the camera choreographs a miscellaneous group of art objects shrouded in noirish lighting, fragmentary narratives emerge but never cohere. Once again, narrative serves as "a mediator not [as] a solution." Speech is subsumed into corporeal performance, for the minimal soundtrack, by Barba's long-time collaborator Jan St. Werner, animates the works—by Ernst Barlach, Renée Sintenis, Gerhard Marcks, and others now sunk into anonymity—creating a sense of play through gesture, stance, posture, and regard.

Far from challenging the paradigm of the archive as a failed futuristic vision, this clandestine conference confirms its rhetoric. Pathos surrounds the museum's erstwhile ambitions to representational totality, making moot the possibility of the redemptive salvaging of these misplaced shards of a fractured history.

Several years earlier, in *Western Round Table* (2007), Barba had addressed the archive from a completely different perspective. Her source for the work was a symposium convened in San Francisco in 1949 under the heading "The Western Round Table on Modern Art." Aiming to "bring a representation of the best informed opinion of the time to bear on questions of art today," its distinguished lineup of (all male) discussants featured critics, artists, art historians, composers, museum professionals, and the like, including Marcel Duchamp, Frank Lloyd Wright, Darius Milhaud, Robert Goldwater, Mark Tobey, Alfred Frankenstein, Andrew C. Richie, and Gregory Bateson.⁷ This time, Barba's riposte took the form of a sculptural projection. Two 16 mm projectors placed together on the ground spool clear celluloid. Each creates a spotlight of white light on an adjacent wall, into which the looming architectonic shadow of its antagonist, the other projector, enters. The soundtrack is comprised of extracts from two Federico Fellini films, cut so that the projectors appear to be conversing with each other, albeit in terms far removed from the august tone of the

proceedings of the West Coast conference. Never quite obliterated by the mechanical sound produced by the anachronistic projectors, the musical refrains are initially teasing, entertaining, and even captivating. Soon, however, the soundtrack becomes an earworm, unforgettable and ineradicable. An epigraph to the transcript of the proceedings by Suzanne Langer contains the claim that, in characterising a philosophy, the solutions offered to questions are less revealing than the formulation of the problems: "Its answers established an edifice of facts," she contends, "but it's questions make the frame in which its picture of facts is plotted."⁸ When filtered through Langer's observation, Barba's idiosyncratic embodiment of the proceedings of this celebrated event into a pair of sombre architectonic silhouettes—dematerialised behemoths speaking imperviously over each other—may not be as negative as it initially appears.

That same year, 2007, *They Shine* proposed that contemporary scientific imaginings are difficult to distinguish from what was once more properly the realm of science fiction.⁹ Something quite different emerges, however, from *A Private Tableaux* (2010). Images suggestive of modern cave paintings are revealed to be the tracings left in passageways under the River Mersey in Liverpool over more than a century by engineers studying pressure points created by vehicles travelling in tunnels overhead. Here, Barba, somewhat uncharacteristically,

forgoes a cartographic study in favour of a semiotic enquiry that reads the abstract signs as figurative symbols. Apparently ignorant of their origins, the commentator (whose report supplies the text in this film) likens them to a form of "automatic writing" made by the engineers' "subliminal selves" "for their own pleasure." They then attempt to characterize the markings that comprise these "private tableaux": in addition to "a flight machine" and "a carriage and horses," there is a portrait of a young man "drawn from memory." Comparing this face, with considerable latitude, to a drawing by Jean Cocteau, the writer concludes that it "gave its creator much trouble and little satisfaction." Forgoing the dispassionate objective address proper to scientific interpretation, this fanciful semiotic parsing betrays a whimsicality rare in Barba's work. Yet it is precisely the risible character of these wild surmisings that throws attention back onto the terms in which the enquiry was formulated. Once again, Barba's primary concern is the structure that frames and governs the narrative impulse.

Narrative as a form of cultural critique may serve as a means of both mediating history and making sense of contemporary experience. For Italo Calvino, storytelling became a vehicle for galvanising an audience that had grown passive, first under Fascist rule and then by rapid socio-cultural developments in the postwar years. Calvino came to believe that, far from requiring a polemical illustration of ideological positions,

a committed literature required the deployment of style and craft in service to a form of realism that had nothing to do with naturalism. Fiction demanded attention, “first of all, [to] image and word, attitude, pace, style, contempt, defiance.”¹⁰ Realism, not naturalism, is also Barba’s preferred mode; so, too, storytelling for her is a matter of style and attitude as much as one of craft. The sources of her narratives are culled from a wide range of literature. Sometimes, as in her use of Creeley’s poem in *The Long Road*, she borrows directly; more often, as in *Somnium* and *Let Me See It* (2010), which is based on a story by Jorge Luis Borges, she recasts or paraphrases the original text. Literature is nonetheless as fundamental to her conception of cinema as its visual counterparts.

Whereas cinema is variously conceived as a kind of writing or inscription in many of Barba’s film works, sculpture is deployed to literally give material form to language.¹¹ *I Made a Circuit and Then a Second Circuit* (2010) is one of a group of works that might be termed protocinematic devices, for each is composed from a sheet of felt suspended in space so that it functions as both screen and projector. When light is projected onto the dark lattice from which a text has been cut, a luminous script appears on the wall beyond. The residues of one of these felt drapes comprise *They Come and Go* (2009). Piled into a heap on a sheet of cloth laid on the floor and lit with

the beam of a projector, shards of language become an archive whose narrative potential is infinite.

Barba’s acuity to text extends to its modes of delivery; the voices on her audio tracks are as particular as they are memorable. The suave, confident timbre of the narrator in *They Shine*, for example, recalls the tones of the male leads in a certain type of Hollywood film. By cultivating that association, Barba seeks to underline the fact that the inhabitants of the uncanny milieu live between two phantasmic realities: the site on which the eerie array of reflectors was built is not far from Tinsel Town. Throughout her oeuvre, the monologues of (male) experts are always measured and cool, verging on laconic. However, when counterpointed with the indistinct, insecure voices of amateurs issuing uncertainly from the margins and interstices—as found in *Somnium*—these disciplinary tones sound slick, and their explanatory powers suspect.¹²

Storytelling depends as much on the reader or listener as on the authorial voice. In literary theorist Roland Barthes’s well-known formulation, reading (like viewing) creates a space of encounter where the reader and the multiplicity of writings that comprise any text “blend and clash.” Barba’s richly layered exploration of this encounter is perhaps nowhere more artfully manifest than in *It’s Gonna Happen* (2005). An imaginary conversation that could plausibly have been part of the political machinations that have

become known as *Watergate* provides the raw material for what may be a scene in a forthcoming feature film. The screenwriter's directions for this scene appear as phrases projected against a black ground, while on the soundtrack a re-enactment of the conversation is played out in the form of a brief phone call. Viewers simultaneously read the texts and listen to the terse conversation in which two men plot a kidnapping, conjuring the scene in their imagination. As they struggle to take in both the written and spoken words unfolding in tandem but not in sync, they find themselves occupying two antipodal spaces: they are at once inside this illusory realm and outside its fictive boundaries. Independent from yet intermingling with the audio track, the sound of the projectors is a spur to

the realisation that an unmediated experience of cinema is no longer possible; the technologies of film and our attitudes towards it are inevitably filtered through its histories, conventions, and genres. By requiring her audience to negotiate between two contradictory positions, Barba enjoins them to reflect on film as a medium, and on its traditions and genres. The politics of *Watergate* are here both a pretext and a foil to her abiding subject: the politics of viewing. Time and again, the manifold modes of introspection that mark many of the medium's exemplary modernist projects are integral to Barba's narratives. Self-reflexive texts, suspended stories, and speculative imaginings become the preferred means through which she constructs a mode of viewing—an ontology of vision—appropriate to today's cinema.¹³

- 1 Gale E. Christianson, "Kepler's *Somnium*: Science Fiction and the Renaissance Scientist," *Science Fiction Studies* (March 1976): 79–90. See also Raz Chen-Morris, "Shadows of Instruction: Optics and Classical Authorities in Kepler's *Somnium*," *Journal of the History of Ideas* (2005): 223–41.
- 2 The risk of publishing such highly controversial views in early seventeenth-century Europe was considerable, as evidenced by the fact that an earlier version of the manuscript had led to the imprisonment of the writer's mother as a suspected witch.
- 3 Rosa Barba, *A Curated Conference: On the Future of Collective Strength within the Archive*, exhibition brochure (Madrid: Museo Nacional Centro de Arte Reina Sofía, 2010). All subsequent quotes are taken from this brochure.
- 4 See Hal Foster, "Archives of Modern Art," *October*, no. 99 (Winter 2002): 81–95; see also Hal Foster, "An Archival Impulse," *October*, no. 110 (Fall 2004): 3–22.
- 5 I am indebted to Foster's account of Adorno's essay. See Foster, "Archives of Modern Art," 84–85. All subsequent quotes in this discussion are taken from Foster's text.
- 6 This is, in fact, the first of what is planned to be a four-chapter series; the second chapter, entitled *The Hidden Conference: A Fractured Play* (2011), had its debut in *Stage Archive*, Fondazione Galleria Civica—Center of Research on Contemporary Art, Trento, Italy, in 2011.
- 7 For the transcripts of the conference, see "The Western Round Table on Modern Art (1949)," ed. Douglas MacAgy, UbuWeb, <http://www.ubu.com/historical/wrtma/index.html>.
- 8 Suzanne Langer, in see "The Western Round Table on Modern Art (1949)."
- 9 The focus of *They Shine* is a vast array of futuristic structures, at once "glamorous" and "deadly," that purportedly a meliorates a hostile environment, transforming it into a habitable locale. It is subject to uneasy speculation and scepticism from bewildered locals. As in *Somnium*, a wryly ambivalent response to scientific imaginings in the face of nature seemingly running amok is the subject of Rivka Galchen's writings. See, for example, Rivka Galchen, "Disaster Aversion: The Quest to Control Hurricanes," *Harper's Magazine*, October 2009, 55–63, <http://www.harpers.org/archive/2009/10>.
- 10 Italo Calvino, preface to *The Path to the Nest of Spiders* (Hopewell, NJ: Ecco, 1976), vii–viii.
- 11 *Printed Cinema* is the title Barba has given to an ongoing series of publications, each edition of which accompanies the production of a particular work or body of works and reflects on the process of its making.
- 12 The only exceptions to this roster of male voices are the two female speakers in *Parachutable* (2005). Though they do not interact, their voices interrupt and overlay each other, reinforcing the effects of contrast and resistance through which image and sounds are related.
- 13 "The real protagonists are stories suspended in air," states one of the two female voices in *Parachutable*.

"A man and his HOBBY-HORSE, tho' I cannot say that they act and re-act exactly after the same manner in which the soul and body do upon each other: Yet doubtless there is a communication between them of some kind, and my opinion rather is, that there is something in it more of the manner of electrified bodies, - - and that by means of the heated parts of the rider, which come immediately into contact with the back of the HOBBY-HORSE. - - By long journies and much friction, it so happens that the body of the rider is at length fill'd as full of HOBBY-HORSICAL matter as it can hold; - - - so that if you are able to give but a clear description of the nature of the one, you may form a pretty exact notion of the genius and character of the other."

—Laurence Sterne, *The Life and Opinions of Tristram Shandy, Gentleman*¹

If the approach to an object of research is founded in the beginning by this thematic object of research, or, in other words, if the initial investigative approach to the object is influenced by the character of the object, it might be the case that a methodology that functions in one of these thematic relations may not function in another. It could be said, then, that what marks the difference between organic chemistry and marine zoology is a difference mirrored in the established objects of these fields, and that the project of studying dreams in neurology requires and implies

investigative approaches that differ significantly from the methods implied and required in an ethical reading of Fyodor Dostoevsky's *The Brothers Karamazov*. It could be the case that it would always be possible to unhinge one investigative approach in order to apply it to an-other's object, but that nothing or nonsense (or parody, as in the case of Laurence Sterne) would often be produced by this incongruence.

What, then, could be said of art as an academic field? Does it have defining thematic objects of research and established general methods? And if it does, what is the correspondence between the objects of research and the investigative approach?

It might already be suggested that the uniform field does not exist. It might also be said that it is a prejudice—albeit maybe not a very interesting one—that there is a set of core values and a methodological role model when justifying academic work. Maybe this role model is imaginary: an imaginary adversary conjured to define a position. The case may be that a universal role model of a positivist world view—an objectivity that assumes a self-identity, and that does not realise its own character as a condition or presumption, and that requires a certain kind of result—has seeped into and defined an academic atmosphere. Then again, the universal idea of a unified and unifying object of research that defines a uniform and unified methodological approach might be an anachronistic dream that haunts me and requires unjustly justification.

I cannot be expected, can I, to justify myself to those who do not experience art, much less appreciate it? Certainly, sometimes I would like to think so, but I have time and again used other fields of knowledge, traditions, methods, and research in my own projects, which are undoubtedly categorised, experienced, and created as art.

Time and again, I have adopted and mimicked a method or mined information from another sphere of knowledge. Whatever the expectation, some kind of justification or appropriate attitude seems necessary to facilitate this sometimes parasitic involvement. That is to say: How do I experience art as an academic field, a field of research and education, when I interact with other fields, other spheres of knowledge? (I do not expect to make general laws of subjective experience here, though this routine is not altogether foreign, one could argue, to any of us.)

A Way of Looking at Things

I tend to begin with the too general, and then end up in the inordinately particular. It is a well ingrained habit of mine to ride my hobby-horse along these paths—to start with extreme generalisation, as beginning from the base of a triangle and cutting through the middle to end up in the top point. Along the way I might jump a few fences, or go too fast along some shortcuts ...

To talk about relations and structures of things and the investigation of these things is also to talk about both common and special attitudes and a tradition of thinking about these often radically different attitudes. It has been my expectation to find a rational attitude outside of art, and to see it rigidly orientated towards knowledge production. It goes without saying, I think, that this is a completely necessary academic attitude. When I interact with these discipline-specific fields, researching and using studies of, for example, biology or forensic science, the general artistic attitude sets itself apart. As such, in this context, my projects are without results.

That philosophy is not necessarily a field of study with a rigorous orientation towards a production of particular results—that is to say, that it might not proceed along an established method, that it can be, might always be, without results—is a belief that defines the way I read philosophical texts. It could be argued, and I would like to do so, that at their initial moments, philosophy and science share a kind of fundamental thinking, a foundational moment before one progresses in method and action into scientificity. Then, where one progresses, the other can choose to remain. I would like to think that, in the beginning, in this first room, philosophy and art can likewise be characterised comparatively. That art not necessarily progresses as a subject-field, but can take its time to view subjects and subject-fields. The expectations of the object being fulfilled by a rigorously defined investigative approach, as well as the clinical or technical use of the information achieved by such methods, can be completely suspended in art. That is why my work, when it results in art, is without result. But if, in the assumed first moment, these attitudes suspend the expectation of the world as commonly and completely manifested in itself, then there is a link here, between how the artist, the philosopher, and the scientist experiences their worlds. Of course, this is neither a new or original thought; rather, it might be a bit old-fashioned.

There are very old traditions connecting aesthetic contemplation and the curious theoretical spectator; the theoretician and the aesthete both oppose a “natural” everyday pragmatism. These forms of experience, of looking and living, have before been expected to have something in common.

Well before the establishment of epistemology and aesthetics, philosophical contemplation was also aesthetic contemplation: “Since the Greek world view (*Weltanschauung*) conceives of the world as *kósmos*—which literally means decoration, even jewelry—viewing the world as it *really* is by philosophical contemplation means perceiving it as a universe of *systematic order* which is in itself understood as rationally structured and, therefore, *beautiful*.”²

This fundamental idea of *kósmos* reveals that contemplating the world’s structure meant contemplating beauty, that the “world”

and “beauty”—words so different to us—were inseparable to the Greeks. Investigative world viewing, then, is generally opposed to a common eye obscured by pragmatism. Already Aristotle referred to *theoria* as a special attitude, a special way of looking at things, which he exalted as the contemplation of wise folk, the actualisation of knowledge, to the detriment of the practical.³ To get back to the discussion at hand, we might say that, in talking about art, we’re talking about a special sort of experience and contemplation, but we’re also talking about a subject-field (*genstandsfelt*) acting as condition for producing things (*genstande*).⁴ Edmund Husserl, as a more recent philosopher, was specifically engaged with phenomenological attitudes of world viewing. It might be possible to link the aesthetical and the philosophical world viewing in his thinking, maybe even to link them in ways that are beneficial to me—that is to say, to link them in a way that delineates my position when dealing with other fields of study through my artistic practice. Nothing much will be said here of Husserl’s life and thought, other than some general remarks, and some maybe not so general considerations of a remarkable letter to his friend, the wunderkind and poet Hugo von Hofmannsthal:

As soon as the sphinx of knowledge has posed its question, as soon as we have looked into the abyssal depths of the possibility of a knowledge that would be enacted in subjective experiences and yet contain an in-itself existing objectivity, our attitude to all pre-given knowledge and all pre-given being—to all of science and all assumed reality—has become a radically different one. Everything questionable, everything incomprehensible, everything enigmatic! The enigma can only be solved if we place ourselves on its own ground and treat all knowledge as questionable, and accept no existence as pre-given.⁵

A suspension of the typicality of the world is here also a gripping moment of astonishment. When our natural expectations of the world fall away, everything is rendered radically different in this moment of genuine curiosity. To say it another way: the one finding themselves questioned by the sphinx becomes poor in knowledge; that is to say, when astonished by the questions of the sphinx, one does not know what to expect. The philosopher, in this case, finds themselves drawn away and detached from an original state of affairs, drawn to a place where everything has become *questionable* and all they knew *enigmatic*. We could argue, then, that this poverty, this suspension of knowledge, is why this sphinx is a sphinx of knowledge. Husserl then claims that this attitude—the attitude of the philosopher—has something in common with an aesthetical attitude:

It demands an attitude towards all forms of objectivity that fundamentally departs from its “natural” counterpart, and which is closely related to the attitude and stance in which your art, as something purely aesthetic, places us with respect to the presented objects and the whole of the surrounding world. The intuition of a purely aesthetic work of art is enacted under a strict suspension of all existential attitudes of the intellect and of all attitudes relating to emotions and the will which presuppose such an existential attitude. Or more precisely: the work of art places us in (almost forces us into) a state of aesthetic intuition that excludes these attitudes. The more of the existential world that resounds or is brought to attention, and the more the work of art demands an existential attitude of us out of itself (for instance a naturalistic sensuous appearance: the natural truth of photography), the less aesthetically pure the work is.⁶

At the very least, the philosophical and the aesthetical contemplation share a point of opposition: the famously named *natural* attitude. The attitude I have somewhat, so far, tiptoed around. This attitude, which so far has only been mentioned in order to transcend it, could become (when lifted from its proper context) synonymous with a heap of un-reflected presuppositions, a heap only there to be overcome by the philosopher; but we must not forget that, according to Husserl, this attitude is the foundation of all human activity. It can never be completely nullified. All attitudes stem from it, all attitudes come forth from it, because it is in relation to it—the natural attitude, that is—that they differ. If we go a little further into Husserl’s thoughts on what philosophical and aesthetic theorising (*theoria*) could have in common, we might say that they both share a *strict suspension of all existential attitudes*; that is, they share an exclusion of any positing of something as existing. To borrow a clear formulation: “In the neutrality modification it has the index of the ‘as if.’”⁷ The world is, in this case and at this point, turned into phenomenon. So, what is special about this “as if” that is somewhat shared by (though not identical with) the philosophical attitude? If aesthetic contemplation neutralises every *existential attitude*, then it must also find itself in a position other than one of a specialised view within the natural attitude. This means that within the aesthetical attitude, specialised views can be viewed and specialised worlds experienced differently; that is to say, we have given this attitude a function comparative to the phenomenological reduction. In this “neutrality modification,” everything can be viewed aesthetically and the world(s) can let new meanings shine through them. So far, we are still talking about art, not necessarily as a series of progressions internal to the field of art, but as a possible relation to subjects and other subject-fields.

To get at the particular instance of an artwork as it is experienced by a viewer and the premise of this particular instance, we could follow

the trait stemming from these parallels between philosophical and aesthetical attitudes. We have already touched upon it, as it relates to the possibility of being drawn into the work as Husserl describes. At question is this ability of the artwork—the power to give us experiences that break off, in radical ways, from the normal way we go about things. An instance where everything can be brought into question, where everything can become *enigmatic*. New meanings and senses arise, and then, the poverty of knowledge becomes a richness, a freedom in thought and activity. (This meeting maybe comparable to the approach of the artist to other established bodies of knowledge, other regional worlds, and the potential suspension of these bodies' expectations.)

Before accepting all this too readily, we must remember that Husserl wrote within his own time, and we might see a problem in adopting these views when thinking about his privileging of the less sensual, and therefore “purer,” artwork. We might also see a problem with a supposed parallel between a well-defined phenomenological reduction, where the freedom of thought is countered by the philosopher's responsibility to be a functionary of mankind, and an aesthetical reduction, which might not have as well-defined responsibilities.⁸ To let go of the specificity of Husserl's thought, I might end on this positive note: all this is very enabling for my work. At least in the sense that it positions my attitude in dealing with these other discipline-specific bodies of knowledge. To me, it is also a beautiful way of thinking about the way we enter the artwork. The premise of its viewing. How it might suspend our expectations of the world and set out a temporary model of it. In another sense, this sequence of propositions falls within a discussion of the ontology of the work of art and the ontological potential of art as subject-field. Consideration of these potentials has, from the beginning, been essential to how I go about my artistic practice; but how important these considerations are generally to art itself, that I do not know. It might not always be the artist's responsibility to account for the ontological status of their work, and if the artist, as depicted in these Husserlian propositions, does not share the rigorously defined responsibilities of a philosophy bound to systematic, scientific thinking, then the lack of this responsibility might be exactly this freedom: the freedom to not (but not necessarily not) theorise in order to make points.

Shelves, Laymen, and Hobby-Horses

I might say about those of my works, the ones I have spoken about that rely on other bodies of knowledge, that, in making them, I am not involved in “artistic research” but rather “research as an artist.” Both of these kinds of research, I would argue, expect to provoke an opinion, at least in an academic setting, of and from academia.

There has been talk of fields of study as volumes on a shelf and indications of systems that allow for labelling and for things to find their proper place. Such a shelf is, among other places, the educational institution, and in this particular case the university and the art academy.

Once, before I began studying at Malmö Art Academy, I thought of art as homeless and unlabelled. I had a difficult time justifying, on the one hand, an intellectual rigour and, on the other, an intellectual light-heartedness in the doing and thinking involved in making art. This difficulty dissolved somewhat when entering the context of the academy. I like to think of this institution as an especially polymorphic place. The diversity of the art academy—the extreme difference both between and in the students’ practices, but also in the teaching (where else can you go from welding class to a meticulous reading of Theodor W. Adorno—might mirror “art” as notion, the overshadowing word that “art” is, and that many-sided field beneath it.⁹ If, as a layperson, I try to follow Husserl, and if I write somewhat in the way he has written, it would be right to say that Martin Heidegger also thought and wrote about these attitudes and subjects, and that Heidegger’s famous sentence “Science does not think” became one of the inspirations for the mood of this text.¹⁰ It is important to note, though, that Heidegger also said in that same text, “Most thought-provoking is that we are still not thinking,”¹¹ and further that when he said “Science does not think,” it might not have been an objection—or at least not as forceful an objection—to science itself so much as to a general devaluation of other methodologies and spheres of knowledge. That is to say, he objects to an dominant epistemological scientific standard. I’ve made this short digression in order to say that, when the claim is made that “science and philosophy are radically different, but might share a fundamental moment,” it is not always that simple, and to read Husserl and Heidegger is to discover such complexities.

To read Heidegger’s texts and enter into his books can also be to fall into a hole. To write about him can seem just as dangerous. Heidegger writes about the difference between research and thinking, and about philosophy as either thinking or research. He says that within the institution, he fears, philosophy becomes something that it is not. He has a “both tactless and tasteless” fear of what happens to philosophy and thinking in the frame of the institution.¹² A fear of philosophy becoming philosophy-science, philosophy-history—that is to say, a philosophy that does not participate in the ontological enquiries at the centre of scientific crises. A philosophy not alive and actual because it does not do the potentially revolutionary work of questioning the ontological presuppositions that lead the sciences. The considerations are tactless and tasteless because they are formulated by the professor, they are said aloud within the institution of the university; at a lecture, Heidegger spoke about this to his audience.

To return to the subject of art: a fear like this was never warranted for me as a student, during my time at Malmö Art Academy. Art was never in danger of becoming synonymous with a historical determination. I did not experience the doing at the Academy as in danger of becoming devoid of an actual and alive element. Not because art there was universally engaged with rigorous ontological questioning; rather, it was not “actual” in this directly Heideggerian sense, but in the sense that it was not calmed, subsided by tradition. It was a tactless and tasteless work that never stopped questioning itself, a doing that in itself questioned the (what I assumed was) institutional attitude.

I, in my own dealings with both philosophy, science, and carpentry, had and have a special tactlessness, a special privilege—a layman’s privilege.¹³

Hobby-horse riders are often, but not always, laypersons. That in itself the meaning of this word can be faintly offensive—that is, if used correctly—cannot be denied.

The word “layman” somewhat delineates the ordinary, the common, the non-specialised view. The angle of the amateur. To speak in lay terms is to disseminate some complicated content in simplified formulations, that is to say, to cut down on technicalities and jargon: to be plain. It stems from the Greek *laikos* meaning “of the people,” referring to ordinary folk. The primary historical meaning of “layman” (*laikos* through the Latin *laicus*, then the old French *lai*, to “laity,” meaning “secular”), refers to all believers that aren’t part of the clergy, the body of the congregation. Here is firstly a religious hierarchy and secondly an educational and linguistic one. I cannot deny, when interacting with other fields, that I am a layperson. In fact, I would insist on it. To me it is exactly this secularism that makes me free of the expectations of certain disciplines, subjects, objects, and things. Free from a rational, even a philosophical, attitude.

That is not to say all artists are universal laypeople, but it is to say that when I use information produced within other rigorously defined fields, ones that depend on strictly framed methodological approaches, I do not fulfil the structure of this field. I do not fulfil the potential of a certain investigative object. Something else shines through the information. The result reached by rigorous research is hijacked, other potentials are harvested in the twisting and turning, the tactless unhinging and tasteless use. I am exactly a layman.

A Way of Writing (and Writing about Writing) about Things

If all this happened to be serviceable, how, then, would text work inside an artwork, on what premise would text fold into it? This question leads to a more general one: Does language dress or undress (the) experience (of the artwork)?

Maybe it was not a coincidence that it became essential to me, in the first half of my studies, to present texts in my projects. Until this inclusion, my texts had been private and writing was something I did on the side. But it became my focus to include texts, and to include them on the premise of the installation, in my artworks. In these installations, I did not manipulate the material of the letters, these printed or written forms that, as long as they are readable, will always claim their own body. It was important to me that in the reading situation—the situation of being in front of text, engaging with it as with any text—that the reading itself, was as close to a normal reading experience as possible.¹⁴ That is not to say that the text found itself in any insignificant room; it rather found itself in the structure of the specific installation. But I hoped and liked to think that this context facilitated an attitude and a relation to this experience of this artwork without altering the reading situation in itself. My intention was to include a reading happening in intersections between other experiences and other languages, all occurring within the physical and conceptual thematic structure of the installation, as it unfolded for a potentially, hopefully, interested viewer.

Outside or inside installations, that peculiar and subtle body of language already functions on distinct terms. It would be just to talk about it. To actually involve oneself with some investigation of language instead of just saying it—but the issue is huge. It's a topic somewhat incompatible with the length of the descriptions of my hobby-horses in this present text, and to my mind, to be honest, to talk about art is in some way to talk about language (not necessarily in a philosophical or academic way, but possibly so). To become involved with text and language would be to make this fluctuating sketch even more erratic. Suffice it to say, the bonds and interrelations of language and art were and still are one of my hobby-horses, and that in the artwork one can relate in a fundamental way to text and the texts unfolding, and can bring this relation into the particular thematic relation of the work. That is to say, it is not only the text and its contents that is brought into the artwork's citation, but also the reading itself.

So far I might have laid a cloth and folded it around this subject. Maybe I have neared this whole matter through external means and described it through some instrument wholly other than itself. In so doing, I might have placed a doing in an inappropriate thinking. I don't think there is a lot of sculpture in this text, but I don't know how much of this text might be in my sculpture. That is to say: there might be other potentials, inextinguishable and always slipping away, dropped by the mouth and hand and just outside of these words. Academic research as artistic research is not an uncontroversial matter, and the academisation of art can be argued both for and against and can find support or reservation both inside and outside art as an academic or unacademic discipline. To argue that art should resist academisation altogether strikes me as radical.

But to say that an element of it might resist academisation, maybe even resist these words altogether—that is another condition, a hopeful condition. On the other side of this coin: if I have made art complicit with some philosophical determination, it is firstly because of habit, secondly because this debate is my dearest hobby-horse, and thirdly because I do not know how to claim to write of things in and of themselves. It strikes me as something that might always be just on the other side, somewhere other than right here. A manifestation that cannot be written. To write it might be to push it away.

1 Laurence Sterne, *The Life and Opinions of Tristram Shandy, Gentleman* (Ware, UK: Wordsworth Editions, 1996), 53. As this text is partly about habits, I might admit to a habit of referencing *Tristram Shandy* almost every single time I set out to write something remotely theoretical about my artistic practice. It is not only due to laziness, I hope, but due to the remarkable ability of this book to offer its opinion, some mood-setting quote or quirk. This book is perpetually casting its influence on my texts.

2 Sebastian Luft, "Husserl on the Artist and the Philosopher," *Glimpse* 1, no. 1 (1999): 46. Emphases in the original. For further information, see Erik Lund, Mogens Pihl, and Johannes Sløk, *De europæiske ideers historie* (Copenhagen: Gyldendal, 1976), 35–40.

3 If all this had to fall within a more rigorous study, some work would have to be done to separate a few of these concepts that might be glued together here. There might be some kind of difference between a philosophy of art and aesthetics, though they are intertwined. The latter has been generally occupied with, and maybe somewhat historically dominated by, beauty. What is important to note here is that the kind of contemplation of the world involved in experiencing beauty of the ancient Greek cosmic order is not exactly, not even remotely, the same as the contemplation of an artwork today, but that does not mean interesting connections are not rendered visible by thinking about these possible and fundamental etymological links. These connections are all very quickly drawn here; to complicate them somewhat, I refer you to Heather L. Reid and Tony Leyh, eds., *Looking at Beauty to Kalon in Western Greece*, (Sioux City, IA: Parnassos P 2019).

4 "Subject-field" here replaces the Danish "*genstandsfelt*," which stems from the German *gegenstand*, "that which stands," which has the connotations of *themenfeld* and *gegenstandsbereich*. *Genstand* in itself has the first meaning of "object," but also the much broader and more dynamic definition of: "what a feeling, event or action is directed at." *Themenfeld* as connotation is much closer to "subject-field," that is, "the theme of a field of investigation." To use *genstandsfelt* is to use a very broad term, including both a movement and process and a relation to object and subject. My original sentence reads: "For at vende tilbage til diskussionen, kunne vi måske sige, at når vi taler om kunst, så taler vi om en slags erfaring og oplevelse, derfor også om en type kontemplation, men vi taler også om et genstandsfelt som betingelse for produktionen af genstande."

5 Edmund Husserl, letter to Hugo von Hofmannsthal, published as "Letter to Hosmannsthal," trans. Sven-Olov Wallenstein, *Site Magazine*, nos. 26–27 (2009): 2.

6 Husserl, "Letter to Hofmannsthal," 2.

7 Sebastian Luft, "Husserl on the Artist and the Philosopher," *Glimpse* 1, no. 1 (1999): 50.

8 "Phenomenological intuiting is thus closely related to the aesthetic intuiting in 'pure' art; obviously it is not an intuiting that serves the purpose of aesthetic pleasure, but rather the purpose of continued investigations and cognition, and of constituting scientific insights in a new sphere (the philosophical sphere)." Husserl, "Letter to Hofmannsthal," 2.

9 This is of course also the case with many (maybe all) words: in short, it is so extremely particular and so extremely general that to say it just like that—"art"—might induce the same grey flavor on the tongue as, just like that, saying "science."

10 Martin Heidegger, *What Is Called Thinking?*, trans. J. Glenn Gray and Fred D. Wieck (New York: Harper & Row, 1968), p. 8, 135–137. I want to admit here the omission of Heidegger's *The Origin of the Work of Art*, a sometimes quite enigmatic text engaged in thinking through the artwork; to talk about this text would take up a lot of time and space.

11 Heidegger, *What Is Called Thinking?*, 4 (and repeated throughout the book).

12 Heidegger, *What Is Called Thinking?*, 13.

13 Throughout the text, I shift back and forth between using "layman," because of its historical relevance, and "layperson," which is the proper contemporary use. I've tried to use "layman" only when it felt important to keep a special history in mind. See Erik Lund, Mogens Pihl, and Johannes Sløk, *De europæiske ideers historie* (Copenhagen: Gyldendal, 1976), 160–64.

14 Most of the text included in my installations *Layman's Dilemma (Why?) Is the Limit* (2016) and *I Grew Up in This House* (2017) was, for the most part, presented as printed text in catalogues and on the walls. Both installations included speech in the form of video interviews and voice-overs. In *Layman's Dilemma*, obscured handwriting was also included.

Images pp. 126–127:

Stephan Møller, *Layman's Dilemma (why?) Is the Limit*, 2016. MDF, MRI-print, almonds, Adidas running sneakers, paint. Annual Exhibition, 2006, Malmö Art Academy. Detail. Image courtesy of the artist



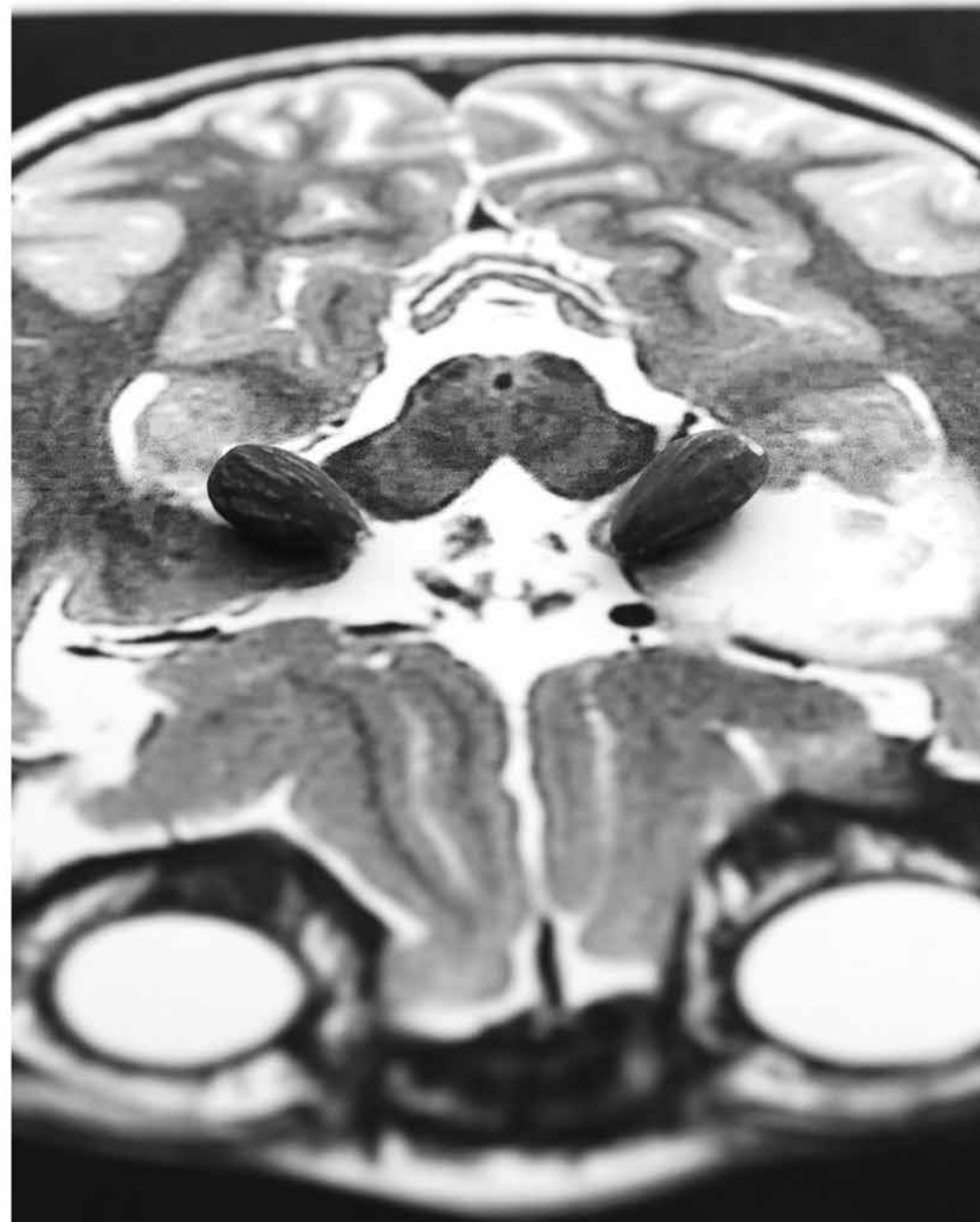

Dishes, Diaries, and Cemeteries: Josephine Fountain Tufts

As a young girl, the person I was closest with was Aunt Jo, my great-aunt. I followed her around doing housework and picking vegetables in the garden. I learned to cook in Aunt Jo's kitchen, which was dominated by a mammoth wood-burning stove—the primary heat source for the two-story twelve-room farmhouse she lived in her entire life, along with her brother. Handmade quilts, homemade beds stuffed with down and feathers, and hot-water bottles filled from the kettle permanently lodged atop the stove supplied local warmth at bedtime. That stove must have been pretty large, in fact as in memory, since Aunt Jo managed to cook a giant turkey dinner with an impressive range of vegetable and side dishes, as well as a pantry full of pies, for twenty or so family members every Thanksgiving.

Aunt Jo's life revolved around her daily list. Written in ballpoint pen on a small unlined five-and-dime pad of paper, each page was a script of the chores she sought to complete that day—"vacuum living room," "laundry," "scrub sink," "dust upstairs bedrooms," "ironing," "pick berries," "mend dress," etc. She typically took two aspirin every four hours, coffee breaks at 10 and 3, and lunch at noon. There were consistent tasks of baking cookies, cakes, and pies, preparing breakfast, lunch, and supper, and shopping in town at the supermarket and Woolworth's. There were family visits and social calls on neighbors. There were holiday celebrations. There was church every Sunday, and in the dozen or so years of its existence during her lifetime—television in the evenings.

One day when I was twelve, Aunt Jo, wearing a roll of masking tape around her wrist and holding the Magic Marker she used to date the jars of fruit and vegetables she canned for

2012–2014

These texts were originally collected in *In Part: Writings by Julie Ault*, ed. Julie Ault and Nicolas Linnert (New York: Dancing Foxes and Galerie Buchholz, 2017). “Dishes, Diaries, and Cemeteries” was originally written as a wall text for Ault’s installation *Afterlife: a constellation*, included in the Whitney Biennial in 2014. Reprinted by permission of the publisher and the author.

winter, took me into the pantry. Opening every cupboard, she asked me what I wanted when she died, so she could put my name on the bottom of the things I chose. I knew exactly what I wanted, but was embarrassed to say. I must have given her an explanation as she let me off the hook—"I'm not sure, I'll tell you later," or "I don't want to think about that." The scene is both vivid and vague in my mind's eye. Whether it actually happened or is something I wished for or dreamed I can't be certain.

I was fourteen when Aunt Jo got sick and went in the hospital. My mother wouldn't let me go see her. She'd turned yellow, I was told—jaundice or hepatitis. She was dead soon after. She might have wondered why her great-niece, who was so devoted—the one she was tender with, who everyone said was "just like her," who slept near her in bed, the one whose chamber pot she emptied in the morning since most Maine nights were too cold to send a young girl to the outhouse, didn't come to see her as she lay dying. Or maybe she didn't. I have no idea then or now of Aunt Jo's interior life.

From necessity, Josephine Fountain Tufts was a workhorse, shouldering and grumbling, shouldering and grumbling. Family members were mostly complicit. "Mark my words," she confided, "they'll expect me to get out of the grave and wait on them at my funeral." I don't know if her prediction bore out, as I did not attend her funeral. Eager to protect me from pain and "negative things," my mother prohibited me from going. On numerous occasions, Aunt Jo asked me to plant a potato plant on her grave someday.

Aunt Jo sputtered incessantly about her brother, Uncle Carl. "That man," she'd say disdainfully as if the reasons for her contempt were self-evident, "that man; just look at him." Some time after she died, he also led me into the pantry so I could show him what I wanted and take "the damn stuff" with me. (Like all my maternal relatives, Uncle Carl was unsentimental. Come to think of it, so are the paternal ones.)

DISHES, DIARIES, AND CEMETERIES

I chose the brightly colored metal tumblers they had used every day and some of the glass ones printed with flowers, as well as some decorated jelly jars, which used to be given complementarily with the purchase of a tank of gas. I wanted two or three serving platters. And there was the small pitcher with blue flowers painted on it that I'd long coveted. When Uncle Carl reached for it, I was scared it would have someone else's name on the bottom, but it didn't. Most precious were Aunt Jo's everyday dishes, which I didn't dare use for forty years. When I finally began to last spring, I shattered a cereal bowl the first week. (Storing things that are "too good to use" is a family trait. After my grandmother died, we found one of her bureau drawers utterly stuffed with fine soaps and fancy packages of body powder—a half-century of gifts.)

Bent-over lame from digging graves at the town cemetery, Uncle Carl hobbled to the shed to get some boxes so I could cart away the dishes. With the transfer completed, he motioned to the jars lined up on the pantry counter—the year's bounty of his signature seriously sour pickles. Uncle Carl didn't waste pickles on people he didn't care for; offering a jar was telling. The routine was that you opened it on the spot and immediately ate one, grimacing against your will while exclaiming its tartness. Then you offered him one, fully anticipating the punch-line response—"I never touch the stuff"—followed by a yelp or hoot delivered as he limped back to the kitchen.

Or maybe he was already sitting in the rocking chair that was formerly the exclusive domain of his sister when you opened the jar. Uncle Carl's personal chair was nestled in the corner between the stove and a window that looked out onto the road. When he wasn't in the garden or at the cemetery, he was in that chair, talking to himself or whoever came by, watching the outside, or writing in his diary. For decades, he recorded the local facts at day's end—the weather, who came to visit, who drove up and down the road and how many cars had strangers at the wheel, hunting stories, the state of his garden,

DISHES, DIARIES, AND CEMETERIES

what was harvested, illnesses, deaths, news from neighbors, and so forth.

When Uncle Carl died, my mother's sister Aunt Dot, who had lived her whole life down the road from him, promptly got rid of all of his things without consulting a soul. Personal belongings, treasures of shared histories, things kept so long they became valuable antiques, and the 1930s kitchen table that was the heart of the house, painted an ethereal shade of light green. My mother and brother and I were horrified. Over and over, I asked her why she opted for going to the dump and calling the antique dealers instead of us—why we had no say in the dismantling of the environment that had such a powerful role in forming us. She always got defensive and a little cross, “Oh, I don't know. I don't know. I just did.”

From *Afterlife: a constellation*. In Whitney Biennial 2014, Whitney Museum of American Art, New York, 2014. Exhibition wall text.

Marvin Taylor: I have to ask this question because I'm curious about it. Does the archive tell the truth about Group Material? [*Ault chuckles.*] And I know that's a totally loaded question.

Julie Ault: Yes. The archive tells a lot of truths about Group Material. I suppose that's one of the fears that have to be confronted: what kind of story do you put out? And how? You know, I guess the fear is really about the violence of history writing. And making an archive is a form of history writing. It's not just because a book extends from the archive. That's not only the history writing but also the formation of the archive itself. You know, throwing this out, keeping this. I mean, I really kept everything. There was nothing that I threw out while cohering the archive from what I had saved. I don't know whether Doug Ashford cherry-picked or not. I somehow doubt it. But the material that Doug gave to the archive had a lot more intermingling of personal notes and things, so he probably did have to make some separations.

I think the archive tells some truths about Group Material, for sure. *Many* truths. But of course, you have to take it all with a grain of salt, because almost anything in the archive could be contested. Working on the book involved finding contradictions and trying to—not exactly reconcile things, but say, Okay, this says this; this says that. I don't remember either one, or, maybe, I remember what happened differently. The archive produces questions and is interesting, I think, for what is omitted and for its absences. And at the same time, you know, another little piece of paper might clarify something or unlock a mystery. I mean, there are so many intangibles of the practice that are not archived, intangibles of the process of the group, right? And those things are not there. So the truths are limited, frankly.

From interview by Marvin Taylor. In *Art Spaces Archives Project*, last modified September 2012, <http://as-ap.org/oralhistories/interviews/interview-julie-ault-founding-member-group-material>.

AIDS Timeline . . . sought at once to contextualize the AIDS crisis and to create a context itself—a didactic exhibit environment that examined recent events to account for present conditions, with the hope of influencing what was to come.

Agency was our horizon, and history—not only that of the 1980s, but history as continuum extending from earlier than 1979 and going on indefinitely. Chronology as guiding device set a linear horizon and performed an anchoring purpose, acting as a focal point from which viewers' perspectives could venture. Within such a setup, the horizon is endowed with the double function of systematizing and releasing information. The horizon opened views to what was above and below the timeline. It opened views to the larger set of conditions articulated by the arrangement of information brought into narrative armature, to reveal the far-reaching associations between political and cultural events that render the historical period legible.

From Julie Ault and Doug Ashford, *AIDS Timeline*, 100 Notes, 100 Thoughts: Documenta Series, no. 32, p. 3. Ostfildern: Hatje Cantz, 2012.

What does thinking in terms of research mean for your self-understanding as an artist?

It indicates being in a state of unending inquiry. Inquiry and growth are not temporally bounded, which means that formal manifestations of a particular investigation, such as exhibitions, writings, publications, and books, are not end points. For me, research terrain is typically tangled in process as it expands and contracts, goes awry, spirals out of control, distills, opens up again, unravels, and so on. The communicative forms produced along the way are temporary materializations of long-term investigations. Unlike the shape-shifting lead-up, they freeze the configuration of ideas and methods and material at a given time. Such productions are part of the inquiry process, perhaps even contrivances to punctuate or frame a period of research. But my engagement does not stop there. This is why I sometimes remain involved with a subject matter for years or decades, manifesting findings in different forms and with shifting perspectives over time.

From interview by Jan Kaila and Henk Slager. In *Doing Research: Writings from the Finnish Academy of Fine Arts*, no. 3. Ed. Jan Kaila and Henk Slager, pp. 57–58. Helsinki: Finnish Academy of Fine Arts, 2012.

“Have you seen my Mondrian drawing?” We went into the kitchen. He grabbed the frame facing the wall next to the sink and held it up so I could see it, though there was no light to speak of. Neither the fact that Martin Wong owned a work by Piet Mondrian nor that he stored it close to splashing water in his sixth-floor walk-up apartment in a run-down building on New York’s pregentrification Lower East Side was incongruous. There, at 141 Ridge Street in apartment nine, Martin painted incessantly.

In Martin’s private cosmos, cultural expression from distant eras and origins cohabited nonchalantly. There were Chinese blue-and-white porcelain stools to sit on and a drop cloth—*cum*—rug to catch wayward paint. Valuable ceramic figurines, books, and cartoon toys stood on every surface. Works of fellow artists that Martin had bought or traded for were interspersed with prints by Utagawa Kuniyoshi and his own paintings on the walls. Tags by graffiti-writer friends covered the refrigerator. In spite of the treasured objects throughout, the place was primarily for painting, so it was pretty messy.

In his collecting activities and in his art, Martin embodied a multiplicity of passions: Chinese ceramics, the paintings of Thomas Eakins and Winslow Homer, calligraphy, archers’ thumb rings, children’s lunchboxes, Mickeys and Minnies and Donalds, sign language, astronomical constellations, graffiti, Loisaída, the writing and person of Miguel Piñero, men in prison, firefighters, Chinatown.

From “Some Places It Will Always Be Eureka and in Eureka It Will Always Be Valentine’s Day,” In *Martin Wong: I·M·U·U·R·2*. Ed. Julie Ault, Daniel Buchholz, Heinz Peter Knes, Christopher Müller, and Danh Vo, p. 5. Berlin: Galerie Buchholz; Cologne: Walther König, 2013.

Gentrifying real-estate machinations go hand in hand with the growth, decay, migration, and conversion of NYC's art districts—SoHo, the East Village, Chelsea, Williamsburg, the Lower East Side, and so on. By the time [Martin Wong's] *The Last Picture Show* took place at the legendary Semaphore Gallery's final short-lived incarnation on Greene Street (1986–1987), director Barry Blinderman had closed both his original gallery on West Broadway (1980–1986) and Semaphore East (1984–1986) on Avenue B. Martin Wong had held a solo exhibition in each. Were his powerful storefront paintings also metaphors for yet another dying environment he held dear?

A series of places and the lived experiences in and around them. A context of concurrences. An era. Eras end constantly. Sometimes an era comes to an end because of massive change, sometimes by degree, and sometimes inconspicuously. Now and then it happens with the death of a single person.

From *Not only this, but "New language beckons us."* Ed. Andrew Blackley. New York University Fales Library and Special Collections, New York, 2013. Exhibition vitrine text.

The Artist as Producer in Times of Crisis

9

Okwui Enwezor

2004

This is a modified version for print of a lecture Okwui Enwezor gave in 2004 at Malmö Art Academy as part of the symposium *Art and Production of Knowledge*, and was part of the Academy's *Yearbook 2003–2004*. Reprinted by permission of Chika Okeke-Agulu, personal representative of Enwezor's estate.

On April 27, 1934, Walter Benjamin delivered a lecture at the Institute for the Study of Fascism in Paris. In the lecture, "The Author as Producer," Benjamin addressed an important question that, since, has not ceased to pose itself: namely, to what degree does political awareness in a work of art serve as a tool for the deracination of the autonomy of the work and that of the author? To address this vexing issue, Benjamin proposed firstly that any work of art that wishes to address political issues must by necessity avoid doing so dogmatically. But, most

importantly, such work should not just show the political character of the work but should include its artistic quality as well. Here is how he outlines the programme of such a work: "You can declare: a work that shows the correct political tendency need show no other quality. You can also declare: a work that exhibits the correct tendency must of necessity have every other quality."¹ For Benjamin, "the tendency of a literary work can be politically correct only if it is also literarily correct."² Contrary to the reception of works that show a clear

political tendency as empty of aesthetic integrity, Benjamin's formulation inscribes a much more rigorous test for any work aspiring to combine the qualities of the aesthetic and the political in a single work. Rather than abjure such work, he raised the critical stakes of what such a work must aspire to. This distinction is important for the issues that I will take up throughout this text in relation to certain conceptions of artistic work by practitioners working beyond the standard aesthetic nomenclature of modern art, namely the autonomy of the work of art through its formal separation from its sociocultural context.

I should also point out that Benjamin's point was made during a period of incredible pressure on artists and intellectuals to commit themselves to an alliance with certain revolutionary programmes during the 1930s. Therefore, his evaluation was to locate what a radical critical spirit in art could be in a time of such momentous, yet undecided, direction in the political consciousness of Europe: between the Bolshevik revolution in Russia and the productivist model of artistic practice it instantiated and the storms of repression unleashed by fascism and Nazism in Western Europe. In a sense, Benjamin's lecture addressed the question of the artist's or writer's commitment under certain social conditions. This would lead him to bypass the question that he raised—namely, "What is the attitude of a work to the relations of production of its time?"—for a far more engaged investigation, which is "What is its position *in* them?"³

Georg Lukács posed a similar question in his 1932 essay "'Tendency' or Partisanship?,"⁴ in which he identifies a prevailing tension between

the work of art and its time against an opposing point of view. What were the relations of production at the time Benjamin and Lukács were writing and how do they compare to those of today? The situation in Europe in the 1930s was marked by a profound crisis in the international public sphere, and therefore could be said to generate a situation in which all art was produced under a climate of instability and political uncertainty. In the Soviet Union, the Bolshevik revolution, which attempted to dissolve the regulatory distinction between classes, became a victim of Stalinism, while the crisis of the Weimar Republic brought Adolf Hitler and the Nazis to power, while the Italian monarchy fell to Benito Mussolini's Fascist Party. The global financial crisis of 1929 after the collapse of the stock market, which led to the Great Depression, further exacerbated the situation. These changes beginning in the 1920s and intensifying in the 1930s had a profound effect on the work of the artistic avant-gardes, not least because a climate of partisanship was produced, bringing about a separation between opposing ideological forces and artistic tendencies, not just on the political front but in the cultural and artistic sphere as well.

In the artistic sphere in Europe, the work of Dada artists is part of this legacy, while in the United States, artists of the Harlem Renaissance embarked on a kind of representational art that sought to depict the nature of Black life under the segregationist politics of the American South. The same impulse could be seen in the context of Mexico, where artists attempted to merge the formal methods of the modernist avant-garde to the realism of socialist

idealism. In Europe, the emergence of Négritude among expatriate African and Caribbean writers and artists (in alliance with surrealism) is part of the spirit of artistic activism of this period. It is important to note the international dimension of this moment.

One may not go so far as to identify the current situation within the global public sphere as similar to that of the 1930s, but they are comparable in two senses: firstly in the deepening sense of crisis that overhangs the entire political sphere, and secondly in the feeling of insecurity and instability such a crisis has produced within the cultural sphere. In the artistic context, today this is clear in the attempts by leading cultural institutions and critics in the media to delegitimise artistic works that bear direct relation to the prevailing political climate of today. In museums, the recent return to canonical art and the historical recuperation of major careers is but a symptom of such attempts at closure that mirrors the one in the political sphere.

It would be unnecessary to explicate here that from the forces of insecurity and instability (across all fields) has emerged a crisis of legitimation that surrounds all cultural production. Today artistic production is once again caught up in a line of separation between ideological forces: between the purveyors of beauty for beauty's sake in art, and practices that insistently attempt to link form and content in the production of artworks in an explicit manner in the social realm. This link, evidenced in many cases as the connection between the social and cultural, political and artistic, constitutes a form of "social aesthetics"⁵ whereby artists attempt to go

beyond the demands of conventional aesthetic norms to comment on the social crisis that pervades all relations of production and reception. However, with the present dispensation of social repression of the memory of past critical activism in the art world (most recently of the AIDS pandemic in the 1980s and 1990s), what we are confronted with in the distinction between artistic imperatives is not a climate of functioning, open, public debate in the leading institutions and media. Rather, the opposite effect is taking root via a pervasive cultural amnesia and the brutal flattening of the artistic field into a market-sanctioned production of taste, discrete narratives, and a curatorial disinclination to view artistic practice in a light not sanctioned by museological norms. The forms of contemporary art that are on offer in this realignment of aesthetic and critical forces, when viewed in the context of the changes occurring in the political and cultural field, appear either strategically ambiguous or obtusely opaque.

If we look back at the period of the early 1920s and 1930s and the conditions of production of that time, we identify it as the clearest moment to observe the struggle between capitalism and socialism as the driving forces behind modern subjectivity. Today, the nature of globalisation and its unleashing of forces of homogenisation and domination confronts cultural producers of all stripes with a different environment within which to think knowledge in relation to power. It has been a mistake of the artistic sphere in the last decade to try to suppress the articulation of this dialectic by art and artists. As in the period of the 1930s, the complexity of the artistic field needs more than ever to make the site of artistic reception a space of vigorous, open contestation

and engagement. The field of contemporary art and practitioners within it are broad and are diverse enough to admit this necessity. Proscriptions against one form of art or against another, however, limits the possibility of artists to truly function in a properly autonomous manner.

For the purposes of reviewing the positions of artistic practice in the current context, perhaps it would benefit our investigation to extend the questions raised by Benjamin and Lukács in their respective texts and apply them to the critical context of contemporary art today. The insights to be gained from these two thinkers are relevant towards understanding and decoding a visible turn that has become increasingly evident in the field of culture at large; that is, a certain critical activism in contemporary art has become a way to re-pose the questions each of them raised seventy years ago. I do so by recourse to a mode of artistic activity known as “collective practices.” My focus is not on activism per se, but rather on work driven by the spirit of activism but otherwise aligned to the methods of art.

To that end, recent confrontations within the field of contemporary art have precipitated an awareness that there have emerged in increasing numbers, within the last decade, new, critical artistic formations that foreground and privilege the mode of collective and collaborative production. But the question to ask is whether this presages the return of the repressed: a bite out of the Proustian madeleine in which memory of a social unconscious much in evidence in older collective practices from the 1950s to the 1980s— from the Letterist International and Situationist International

to Laboratoire Agit’Art, the Art Workers’ Coalition, and Group Material—reappears in the neon glow of a newly minted radicality. If this return could be linked to some of these earlier examples, then we must ask: Is the collectivisation of artistic production really a critique of the poverty of the language of contemporary art in the face of large-scale commodifications of culture that have merged the identity of the artist with the corporate logo of global capitalism? Or is it just a retooling of the old avant-garde mode of dissent already disciplined by museum collections? These questions shadow the return of collectivity in contemporary artistic practice. Given its present insistence and the broad geographic area in which it has sprouted, it appears that something more than art world fashion is the guiding principle behind this turn. Therefore, to ignore the consequences of the disaffection with contemporary artistic practice, and the brutal positionings that take place within the art world by artists working within this mode, is to miss the vital power of dissonance that is part of the appeal for the contemporary thinkers and artists who propose collectivity as a course of artistic work. Of course, we need not be reminded that there is nothing novel about collectivity in art as such. It’s been a crucial strategy—and a “tendency,” in the sense deployed by Lukács—of the avant-garde throughout the twentieth century. How has this “tendency” been deployed? According to Lukács,

“Tendency” ... is something very relative. In bourgeois literary theory ... a text is seen as displaying “tendency” if its class basis and aim are hostile (in class terms) to the prevailing orientation;

one's own "tendency," therefore, is not a "tendency" at all, but only that of one's opponent. The positions of struggle that the various literary factions of the bourgeoisie took up against one another, in which connection, of course, it was generally the more politically and socially progressive trend that was particularly reproached for its "tendency," rather than the reactionary trend, were assumed with double vigour against the first beginnings of proletarian literature.⁶

This reproach of "politically and socially progressive" work for its "tendency" illuminates succinctly the key point of ideological struggle evident in contemporary art today. Of course, it would be naive to speak of the key ideological tussle today as being between bourgeois and proletarian culture. Or that social relations are fundamentally determined by class antagonism. Yet, a persistent antagonism between two socially differentiated ideals of artistic practice remains in the definitions and de-definitions of art; between aesthetic and anti-aesthetic positions much like Lukács addresses in his essay. This tension is particularly acute with work that takes an overtly realistic approach to the representation of social life, whereby "any depiction of society, whether the society of the proletariat or that of the bourgeoisie, and no matter whether this was presented from the class standpoint of the proletariat itself or simply from one close to it, was viewed as 'tendentious,' and every possible argument as to its 'inartistic' and 'hostile-to-art' character was marshaled against it."⁷

While such antique terms as the "bourgeois" and the "proletariat"

concept of society have become intellectually inoperative as descriptors of the contestation of values within contemporary art, the even more antique notions of "tradition" and "canon" endure and remain powerful. Institutions of art and mainstream critics, in fact, insist on them. So what does the artist, disenchanted and alienated from the limited and limiting options of working within a specified grid of modernist artistic conduct, do? If not exactly an outright revolutionary or believer that art can affect any kind of change, there is, minimally, a level of earnest belief (oftentimes treated derisively by cynical critics, especially in times of political repression such as is again current) in Karl Marx's dictum that the intellectual's revolutionary role is not to interpret but to change the world. That artists readily subscribe to this dictum can be detected in a variety of forms of collective or collaborative work. Therefore, a proper understanding of collectivity will have to be traced through its affinities, with past examples, as a tendency of artists' responses to relations of production in their times. This story belongs to the history of modernism proper.

The position of the artist working within collective and collaborative processes subtends earlier manifestations of this type of activity throughout the twentieth century. Collectivity (a good example of its most intellectually stringent form is the work of Art & Language) performs an operation of irruption and transformation on traditional mechanisms and activities of artistic production that locate the sole figure of the individual artist at the centre of authorship. Under the historical conditions of modernist reification, collective or collaborative practices—that is, the making of an

artwork by multiple authors across porous disciplinary lines—generate a radical critique of artistic ontology qua the artist, and as such also question the enduring legacy of the artist as an autonomous individual within modernist art. This concerns the authenticity of the work of art and its link to a specific author. However, there is a level at which the immanence of this discourse is also evidenced in the critique of the author in post-modernism. On both levels, I would argue that the anxieties that circumscribe questions concerning the authenticity of either the work of art or the supremacy of the artist as author are symptomatic of a cyclical crisis in modernity about the relationship of art to its social context and the status of the artist as more than an actor within the economic sphere within which art operates. This crisis has been exceptionally visible in all the decades of the twentieth century.

Historically, collectives tend to emerge during periods of crisis, in moments of social upheaval and political uncertainty within society. After the relative tranquillity of the 1950s, which was a period of coming to terms with the immense destruction of World War II, the political and cultural climate of the 1960s—evidenced by national liberation movements in the former European colonies, the discord of the Vietnam War, the civil rights movement in the United States, the rise of military dictatorships in Latin America, and the women's movement, among many other changes—opened up the discursive space of culture to new articulations of cultural resistance and artistic critique. The crisis of the 1960s not only changed the rules of engagement in the critical spheres of culture, but it also forced reappraisals of conditions of production, the re-evaluation

of the nature of artistic work, and the reconfiguration of the position of the artist in relation to economic, social, cultural, and political institutions. If the evaluative context of collectivity flows from the contestatory demands of political, social, and cultural formations, then there are two types of collective and collaborative practices that are important for this discussion. The first type can be summarised as possessing a structured *modus vivendi* based on permanent, fixed groupings of practitioners working over a sustained period. In such collectives—for example, London-based groups such as Black Audio Film Collective and Sankofa Film and Video Collective, and New York-based collectives such as Group Material—authorship represents the expression of the group rather than that of the individual artist. The second type of collective tends to emphasise a flexible, non-permanent course of affiliation—here the Situationist International is the best paradigm—privileging collaboration on a project basis rather than on a permanent alliance between its members. This type of collective formation can be designated as a “networked collective,” working across affinities of interest whether artistic, discursive, or ideological. Such networks are far more prevalent today due to radical advances in communication technologies in the age of globalisation, whereby a group can engage in a sustained collaborative work with multiple individuals and organisations as Raqs Media Collective, Multiplicity, Le Groupe Amos, and Huit Facettes do in New Delhi, Milan, Kinshasa, and Dakar, respectively.

However, if we are to trace the emergence of the artist as producer in times of crisis, we must do so by first linking up with modernism. Consequently, in collective work

we witness immediately the complication of modernism's idealisation of the artwork as the unique object of individual creativity. For in collective work what is forcefully delineated is the simultaneous aporia of artwork and artist. In the immediate sense, this delineation tends to lend collective work a social or political rather than artistic character, thereby radically vitiating the normative rules of modernist formalism and its insistence on the primacy of the artistic object. As such, the collective imaginary has often been understood as essentially political in orientation, with minimal artistic instrumentality. In other instances, shared labour, collaborative practice, and the collective conceptualisation of artistic work have been understood as the critique of the reification of art and the commodification of the artist. Though collaborative or collective work has long been accepted as normal in the kind of artistic production that requires ensemble work, such as in music and architecture for example, in the context of visual art, over which the individual artistic talent reigns, such loss of singularity of the artist is much less the norm, particularly under the operative conditions of capitalism.

Over the centuries, there have been different kinds of groupings of artists—in guilds, associations, unions, workshops, schools, movements. However, each of these instances always recognised the individual artist as the *sine qua non* of such associational belonging. In fact, the idea of ensemble or collective work for the visual artist under capitalism is anathema to the traditional ideal of the artist as author whose work purportedly exhibits the marks of their unique artistry. Such that the very positivistic identification of the artist as author leads to a crucial differentiation, one that represents

the historical dialectic under which modern art and artists have long functioned: the former on the basis of originality, qua authenticity, of the work of art, and the latter on the authority and singularity of the artist as an individual talent and genius. To designate a work as the product of a collective practice in a world that privileges and worships individuality raises a number of vexing issues concerning the nature and practice of art and the status of the work that emerges from such collaboration, especially in networked versions of collectivity where a method of open work delays or defers any attempt to come to the conclusion of a work as a product.

To the extent that the discourse of collectivity has been circumscribed by the above issues, debates on collective artistic formations and collaborative practices tend to be much more unconcerned with the questions of "Who is an artist?"⁸ and "What is an author?"⁹ However, in certain segments of collective work that have recently emerged, there is a pervasive sense of the loss of this critical distance. One may say that this critical loss of distance is at once by design, in which case it is a strategic move or simply a function of the broader loss of historical interest in the past. The current positive reception of such collective activity—much prevalent in positions that are more driven by pop cultural simulations; in fact, their very fashionability, may have something to do with the historical amnesia under which collectivity's recent revival operates. While collectivity portends a welcome expansion of the critical regimes of the current contemporary art context—which has been under the pernicious sway of money, the speculative art market, and

conservative politics—in order to make common cause with its counterintuitive positionality, and therefore avoid participation in the co-option and appropriation of its criticality, it is important to connect collectivity today to its historical genealogy. This may mean going as far back as the Paris Commune of the 1860s, the socialist collectives of the Russian Revolution in the early 1920s, the subversive developments of Dada, the radical interventions of “neo-avant-garde” movements such as the Situationist International, and activist-based practices connected to issues of class, gender, and race. The nature of collectivity extends also into the political horizon constructed by the emancipatory projects of the liberation movements of the mid-twentieth century. They are registered today within the strategies of anti-globalisation movements.

How do we then place the history of collectivity within the history of modernism? Nearly a century has passed since that fateful turning point in the epic march towards the redefinition of the concept of “the work of art.” Though we could all chuckle today in self-satisfied bemusement and disinterest at the provincialism of the then British minister of culture Kim Howells’s castigation of the work of four artists shortlisted for the Turner Prize for “the poor quality of their work,”¹⁰ which he reduced to nothing more than so much “conceptual bullshit,” in 1914 such bullshit was received as nothing short of heretic. Marcel Duchamp’s insertion of the readymade into the discursive frame of art has acquired its own impressive inventory of epithets and dumbstruck admiration. In fact, its legacy has been called upon in the defence of so much

more than the legitimacy of a number of discursive strategies that insist on the idea that they are works of art fashioned by the autonomous creative entity of “the artist.” Having profaned both the concept of art and artist in order to bring modernism back to a zero degree of its task of legitimation, Duchamp’s readymade in a sense could be viewed as the founding philosophy of what is today designated as “contemporary art.” The genealogy of such strategies (which consistently attempt an improvement of our understanding of the nature of the artistic object or statement) is fundamental to the historical discourse of modern art. It also furnishes the fundamental dialectic between modernist art and contemporary art, not least because the distinction between them remains at once porous and tendentious. Modernist art is said to have its roots in the myth of originality,¹¹ in the idolatry of images and objects whose very physical existence was dependent on the reified nature of their objecthood. Or, if we speak specifically about images, we tend to relate to their iconicity and uniqueness on the basis of aura as one would religious images or objects.¹²

Moreover, modernist art was said to function with an internalised awareness of the hierarchy that structures the relationship between its constitutive parts, such as how the relationship between works of art came to be conceived as distinctions across genres, forms, and mediums (a heritage, no doubt, of classicism), evident, for example, in a line that separates “fine” and “applied” art or the relationship between mediums such as the one between painting and drawing. On the other hand, contemporary art is understood to proceed from the evisceration of the idea

of the authority of originality and the aura of the image. Rather, through its heterogeneity and the structure of simultaneity, it has overseen the remarkable dispersal of the legacy of modernism.

One legacy of the expansion of the idea of contemporary art is the degree to which it abjures and has remained largely ambivalent to the dialectic of modernist art (between originality and aura), having taken aboard the idea that art is defined neither by its specific medium nor by the form through which it declares the very purpose of art, but rather simply by the context of art. Of course, the two models for this cultural turn in the understanding of art in the twentieth century remain cogent. The first being the radical termination of the idea of originality that Duchamp first inaugurated through his readymades and critique of painterly modernism ("retinal art," as he famously referred to it), which culminated in *The Large Glass* (1915–23). The implications and consequences of Duchamp's intervention are already well known, even if they have developed their own cargo cult of epistemological reification, sedimentation, and certainty as art history. However, Duchamp's mutilation of the perceptive order in which the work of art is embedded is more than the transition between the meaning of an object, whether technologically fabricated, as many of his readymades were, or artistically fabricated, in which originality rests on the fact that the work is singular and not repeatable by any technology of standardisation. It is in the discursive domain of art's definition that Duchamp's proposition is considered to generate that moment when the history of contemporary art is said to begin. Similarly, Walter Benjamin's

conclusions in his essay "The Work of Art in the Age of Mechanical Reproduction" have been equally deployed as the watershed theory that defines the tension between modernist art and contemporary art, between the artistically fabricated object and the technologically generated image.

If we take Duchamp's intervention and Benjamin's theory as the immediate ancestors for the proposition of what Thierry de Duve identifies in Duchamp's gesture as the shift from "here is art" to "this is art,"¹³ we would, nonetheless, still remain very much preoccupied with what the object of art as such is after the re-elaboration of its plasticity. There is, of course, a second horizon through which we can read some of the conclusions that, since the 1960s, have continuously questioned both the nature and status of the work of art. The struggle as such is not so much how does art generate its meanings through its many objects, forms, and mediums that can now be extended to activities or non-activities, be they technologically fabricated, digitally serialised, indexically structured, or programmatically schematised. Rather, it is: Can art now go beyond embedding itself in specific objects of minimalism's phenomenological posture, or move to a truly radical position that is its complete reduction into nothing more than a linguistic description?

The severe de-retinalisation that such a reduction proposes is part of the legacy of conceptual art, in which recourse to language carries the seed of Duchamp's original idea, except now the model of "this is art if I say so" has produced a moment of deep fecundation in which its social ramification has tended to open up the space of contemplation to that of

speech, or just simply the exchanges that inhere from a range of social relations (this is fundamentally the place opened up by collectivity), thereby transporting the experience of art into sites of the multiple activities that today generate art as idea, discourse, activity, or whatever as an extended field of many types of transaction. Part of this synthesis or fusion of the contemplative and the linguistic, the formal and the social, at any rate led conceptual art to attempt also to abduct the traditional role of the historian and critic for its cause. Again, the work of Art & Language and such artists as Joseph Kosuth and Dan Graham is significant here. Conceptual art was not simply content with destabilising the traditional categories within which art functioned, it also sought to inaugurate and propagate a philosophy for such destabilisation as the basis for an ontology of advanced contemporary art. Kosuth especially made this part of his credo, as witnessed in his "Art after Philosophy" model.¹⁴

If contemporary art as inaugurated by Duchamp in his casual still lifes of quotidian objects refashioned as readymades in 1914 was already impatient with modernist claims of the uniqueness of vision, skilful finish, and such as the prerequisite for judging correctly what a work of art is, modernist critics were no less dismissive of the claims of certain contemporary styles, seeing them as either fraudulent or ideologically compromised. From cubism onwards, and throughout the twentieth century, modernist art has had to grapple with the constant pluralisation of the concept of art and its forms and mediums (e.g., the cubist collage and film montage) and the hybridisation of the art object (e.g., the readymade and Dada). At

every turn in the shift towards pluralisation and hybridisation, modernist art has tried to prove its own staying power, and it is not devoid of its own spectacular weapons against the impudent assaults of Duchampian contemporary art, as witnessed in its attempt, every decade since the appearance of the first readymade, to storm the barricades and seize back the space of representation that painting and sculpture represent for classical art. In a sense, the historical debate between modernist art and contemporary art rests on a single philosophical tension, namely the issue of the authenticity of the work of art. For example, Benjamin observed that "the revolutionary strength of Dadaism consisted in testing art for its authenticity."¹⁵

The issue of the authenticity of the work of art, and by extension that of the artist (who in a typical post-modernist term became the author), has a sociocultural basis beyond the art historical questions it generates, especially as the basis for conceptual art became more and more dissociated from the polemics of statements about art to the politics of that statement and, finally, to the politics of representation. The legacy of Duchamp in the formulation of the theory of conceptual art produced consequences beyond his original intent, to the extent that, at a certain juncture, Duchamp ceases to be a useful avatar for the range of heterogeneous strategies and statements that have devoted themselves as expressions of artistic intention outside the framework of objects and images.

Benjamin Buchloh has rightly observed that in "confronting the full range of the implications of Duchamp's legacy ... Conceptual practices ... reflected upon the construction and

role (or death) of the author just as much as they redefined the conditions of receivership and the role of the spectator.”¹⁶ Though Buchloh’s statement is quite correct, in relation to the spectator the historians of conceptual art have not gone far enough in theorising the fundamental political nature of spectatorship. What I mean is that in the postwar transformation of the global public sphere, the traditional construction of the spectator within both Western and modernist understanding experienced a radical rupture with the emergence of postcolonial discourse. Postcolonial and civil rights discourses put under the spotlight a new kind of spectator. This spectator would construct, during the postwar period, new subjective relations to institutions of Western democracy and economics.

For example, in the United States, desegregated institutions needed also to rearticulate the philosophy informing their work as public spaces. The appearance of the subject within the framework of the experience of art was a new phenomenon which hitherto had been unacknowledged, insofar as the concept of the institutions of art experienced pressures to be more attentive to the publics towards which it directed its undertakings. It was not just the primacy of the art object that demanded new consideration, but also the primacy of the social exclusions that purportedly were built into the way institutions of art mediated the history of those objects. The postwar democratic public sphere repositioned the spectator in ways that would only become much more clear with the emergence of certain politically centred interpretations of subjectivity—models of subjectivisation that were dependent on a number of socially bounded

identifications (gender, sexuality, race, ethnicity, etc.), of which multiculturalism today functions as the dark spectre of the politics of the subject. While conceptualist paradigms may have opened a space for the considerations of some of these shifts, surprisingly the operation of conceptualism still predicated itself on the hinge of the modernist dialectic of the object and the gaze. As such, the shift in the role of the traditional spectator within the structures of hegemonic institutions of power such as museums and Western gallery systems was not substantially articulated in the operations of conceptual art. Already in 1952, a decade before conceptual art purportedly began the redefinition of the role of the spectator, Frantz Fanon had called this homogeneous spectator into question in his classic psychoanalytic study, *Black Skin, White Masks*. Fanon’s study of subjectivity draws from the master-slave relationship of the self and other in colonial discourse, in which he foregrounds the importance of language whereby “to speak is to absolutely exist for the other.”¹⁷ Therefore, the fact of conceptual art’s interpellation of language into the field of artistic vision cannot simply be adopted, in toto, as the radical critique of language—for its own action of critique is called into question with regard to the self-sufficiency of its own language games.

The Production of Social Space as Artwork: Protocols of Community in the Work of Le Groupe Amos and Huit Facettes

So far I have focused on the historical and intellectual trajectory necessary for the understanding of collective practice within the field of contemporary art. While artists across a

broad global arena have adopted this method with great creative and stimulating vigour, I will focus here on two key groups: Le Groupe Amos from Kinshasa, DR Congo, and Huit Facettes from Dakar, Senegal, that have emerged in Africa in the last two decades. My focus owes much to the fact that the two groups operate from within a specific cultural and historical context to which modernism and sometimes contemporary art have been antagonistic. If the dialectic between modernist and contemporary art has been caught in attempts at elucidating, within each field, what the authenticity of the work of art and artist (author) is, the unexplored political consequences of this question take us now to the important question of identity formation, the politics and crisis of the subject, and the processes of homogenisation and assimilation of non-Western cultural sites into the framework of late capitalism. Because most non-Western artistic contexts lack power (in the neoliberal sense of market capitalism, in which modern and contemporary art objects function), it is often easy to either dismiss their importance or ignore them as important contributors in the changing discourse of art. The history of modernism in relation to African art is well known in this regard. Africa fulfils a role in which it could be absorbed as an astonishing example of a certain ethnographic turn towards which modernism's fascination with alterity has always tended. Or, in the very worst case, as embarrassing examples of an impossible mimesis in the resemblance of modern African art to the "superior" Western paradigm. In this way, modern African art is treated as either exotic or strange, corrupted by colonial mimicry and devoid of authenticity.

In whatever epistemological mode African art or artists are grounded, in the larger discussions of modernism or contemporary art it is first on the basis of a pure disavowal, what the critic Hal Foster calls a "process of dis-identification,"¹⁸ that both African art and artists resemble the least what modern art is about. This is an old argument. Yet, another way this dis-identification occurs is through appropriation and assimilation of Africa as an effect of certain tropes of authenticity and cultural purity invested with the power of ethnographic realism. Most notably, for the African artist authenticity has become a congenital condition. Authenticity, because it partially hosts in its ambiguous carapace the kernel of the stereotype, is a burden unsupportable by the practical, conceptual, and historical forms through which it is represented in contemporary cultural discourse. Authenticity, rather than affirming the continuities of a cultural past—based on a certain nineteenth-century "Western romanticism"¹⁹ as a general signifier for an African tradition—in fact comes off more as the antithesis of such continuities. Thus, authenticity's primary structure is the fiction that reproduces it as the figure of a unitary, homogenous belief in the particularism of an African essence.

Authenticity as an idea towards the standardization, hence banalisation, of the complexity of contemporary African identity appeals to certain romantic notions of African uniqueness that have been promoted for so long. Authenticity therefore must be understood as the handmaiden of an ethnocentric discourse blind to the complexity of the modern map of African social reality, and doubly blind to the multiplicity of identities forged in the crucible of colonisation, global-

sation, diaspora, and the postcolonial social transformation of insular cultural worlds. Authenticity is not only a vague notion with ambiguous features that no one can possibly identify, let alone describe its practicability in the context of African artistic procedures, but also a code for fixity, absolutism, atrophy. Writers such as Wole Soyinka and artists such as Issa Samb and the members of Laboratoire Agit'Art in Dakar were correct in questioning the efficacy of the ethnocentric model of Négritude in the 1960s.²⁰ In the same manner in which their critique of Négritude as a universal of the African world functioned, so too did their rejection of the false claims of Eurocentric universalism over the territory of other cultures. To say this much is not to be beholden to the relativism that governs what passes today as cultural exchange, but to point to the difficulties that reproduce dichotomies that ground themselves in the discourse of power.

In its attempt to arrest the African social imaginary, one could impute that the denotative idea behind the construct of authenticity is its primordialism, that is, as an a priori concept that determines and structures the bonds of the self to the other—the other as always unchanging, arrested, bound to tradition, tethered to the supernatural forces of nature; the other whose social temporality is governed by an innate world and its systems of kinship, beliefs, and symbols, all of which remain beyond the reach of any structural or material transformation of reason and progress, except in superficial circumstances, after which the other returns back to an originary state. Therefore, authenticity as primordialism conceives of the other in a vacuum of history, locates them in the twilight of origin,

fixed in the constancy of the unchanging same. Or, on the other hand, it conceives of the other as an excess and spectacle of history, as a cycle of repetition, mimicry, demonstration, performance, habitation, expression, and practice.

This latter idea of authenticity as primordialism, in Michael Taussig's terms, could be called part of its mimetic faculties;²¹ that is, its tendency to quote, copy, and imitate that which is believed to be the original. So, in a paradoxical sense, the authentic is always false. According to such a logic, the mimetic faculty allows for the inexhaustible permutations of quoting, copying, and imitating an idea of African authenticity. For example, "real Africa" is traditional rather than modern; rural rather than urban; tribal and collective rather than individual and subjective; Black rather than hybrid; timeless rather than contingent.²² With every process of affirmation and disavowal, we participate in the game of ceaseless mimeticism and reproduction of the authentic. Taken to their most absurd level, these binarisms and conjectures take on a facticity and truth, which should then govern and aid all relations of production in art, literature, film, music, and other spheres of modern knowledge production. Yet in the same logic we witness the contingency of the destiny of the African artist in the face of various instruments of modern subjectivity, one of which concerns their liberation from the determinism of race. We may pause here to pay attention to the full emergence of a crisis: the crisis of the African subject.²³ In the game of authenticity, the politics of the subject is an important one in relation to how this crisis is critically engaged. For the African subject, this crisis is paradoxically engaged through the instrumen-

tal rationalisation of the idea of free will. Achille Mbembe captures this succinctly. He writes:

The triumph of the principle of free will (in the sense of the right to criticize and the right to accept as valid only what appears justified), as well as the individual's acquired capacity to self-refer, to block any attempt at absolutism and to achieve self-realization through art are seen as key attributes of modern consciousness.²⁴

For those Africans who disavow the fiction of authenticity—the mimetic excess par excellence— what choice do they have beyond the violence of the dichotomy between the fake and real,²⁵ authentic and inauthentic, primordialism (backwardness) and modernity (progress), the universal and the particular? If we are to hypothesise authenticity what else could it mean beyond its interpretation as an act of constant self-repetition, self-mimicry, and self-abasement in the stew of origin? Shouldn't we begin the quest for the authentic in African cultural discourse first by ridding ourselves of all illusions that it can be conjured by a simple appeal to the past and tradition? Secondly, should we not be insisting that the most meaningful place to seek the figure of the authentic is not in the swamp of fantasies in which Africa has been caught as the true historical opposition between reason and unreason, between the West and the rest, but elsewhere: in the very politics of the subject? The quest for the authentic, it seems to me, is in the search to locate the African subject, not simply as African (for that is already a given),

but as a universal subject endowed with capacities far beyond the lure of authenticity. Such a subject is neither a mere fantasy of overdetermined cultural theory nor a fanciful post-modern caricature. Pace Mbembe, we can therefore present the case of the African subject in the following manner:

The constitution of the African self as a reflexive subject ... involves doing, seeing, hearing, tasting, feeling, and touching. In the eyes of all involved in the production of that self and subject, these practices constitute what might be called *meaningful human expressions*. Thus the African subject is like any other human being: he or she engages in *meaningful acts*. ... The African subject does not exist apart from the acts that produce social reality, or apart from the process by which those practices are, so to speak, *imbued with meaning*.²⁶

If the speech of the African subject is "imbued with meaning" at the moment they speak (whether as an artist or not), cultural subjectivity for the modern African artist opposes itself to the binary violence of either/or, universalism/particularism. The complexity of such a speech extrudes from the dynamism of multiple traditions and is transformed in the aleatory patterns of juxtaposition, mixing, and creolisations that define the contact zone of culture, especially after colonialism.

As I have tried to show above, the discourse of crisis²⁷ is not only endemic to the political and social formation in Africa, but it also concerns the crisis evident in the processes of subjectivisation, by which I mean not just the ability to constitute a

speech not marked by the failure of intelligibility and communicability but the very act of creative transformation of African reality. Thus the process of subjectivisation is the ability for a given subject to articulate an autonomous position, to acquire the tools and power of speech (be it in art, writing, or other expressive and reflexive actions), and it is connected to the idea of sovereignty. This sovereignty operates around the ethical-juridical territory of power relations, namely between the recognition of the given fact of natural rights and that right regulated and legitimised by the law. Here, the individual is "subjectified in a power relationship."²⁸

The idea of the "sovereign subject" as it concerns Africa is important if we are to rethink questions of authenticity in cultural practice. I want to do so by turning to the position of the artist as producer in times of crisis.²⁹ This crisis points first to the crisis of the postcolonial state,³⁰ and to the general climate of uncertainty unleashed by globalisation. For Africa in particular, there is also the crisis of development discourse that has been the bedrock of the democratisation and liberalisation of the postcolonial state and economies since the 1960s. Here it is important to note that the postcolonial state has been exacerbated in the last two decades by the brutal macroeconomic structural adjustment programs (SAPs) of the World Bank and International Monetary Fund (IMF) during the 1980s and 1990s. Though there are disputes among experts about the actual causes of the kind of congenital underdevelopment we see in Africa today, it is generally agreed that SAPs deepened it and weakened the capacity of the state to manage and respond effectively to its effects.

SAPs put into place the inability of a host of African subjects to properly conceptualise and formulate their own futures; that is, to speak as true social subjects. All throughout Africa, institutions and citizens are vulnerable to the rapacious calumny of the industrial forces of economic rationalisation and political coercion. Rather than reform and economic growth as promised, the shock of the experiment at liberalisation produced stagnation, structural atrophy, collapsed economies, deep poverty, failed institutions, and the loss of state autonomy from donor institutions and markets. Liberal reform of the economy (devaluation of currencies, imposition of austerity measures, privatisation of state assets) set in motion a deepening crisis, leading to further underdevelopment and dependency across institutions. Of these, cultural and educational institutions were the most vulnerable. Consequently, artists and intellectuals were placed on very precarious ground in society. Only recently have liberal economists, the World Bank, and the IMF begun to acknowledge the failure of the economic shock therapies³¹ that have affected institutions across the continent. As a test case, the neoliberal ideology of free-market capitalism not only failed in Africa but also produced a wave of disenchantment, instability, and erosion of social networks.

If, as Michel Foucault claims, "the theory of sovereignty assumes from the outset the existence of a multiplicity of powers ... [imagined as] capacities, possibilities, potentials,"³² then the grim assessment of the postcolonial state and the postcolonial subject within the developmental discourse of neoliberal market ideology introduces a series of illiberal effects. But here we need to fashion

a proper critique of crisis as not always the logical outcome of the neoliberal transformation of the modern African state. Yet, its effects cannot be discounted, especially when the state fails, as we can witness in the context of what is known as the Democratic Republic of the Congo. Seen from this example, crisis not only situates the subject, it mortifies the subject. The chief and primary effect of this is traumatic. This trauma compels a complete rethinking, if not necessarily the overhaul, of the forms, strategies, and techniques of everyday existence as well as the devices through which cultural production occurs and the places where it is grounded. Because this crisis affects the effectiveness of institutions, conditions of production, and the visibility and quality of discursive formations, the position of the artist and intellectual within the African public sphere is constantly called into question. Furthermore, the coercive power of the state to force artists and intellectuals to adapt their practices according to an official dictum of the state apparatus forces attempts at disclosing the autonomy of the artist and intellectual under such force.³³ Many intellectuals, researchers, and non-governmental organisations (NGOs) working in the area of African political and cultural sectors in recent years have focused on different strategies of strengthening civil society, governance, democracy, and informal economies as a way of boosting the sovereignty of the subject in times of crisis.

This has given rise to a number of responses. Though much of the focus has been concentrated on the work of NGOs, community associations, social-science think tanks, and multilateral global institutions, very

little attention has been given to the dimension of culture. I do so here by examining the work of two distinctly different collective groups of practitioners who have made the analysis of the conditions of production under this crisis the sine qua non of their reflexive activities since 1989 and 1996, respectively. The two groups, Le Groupe Amos in Kinshasa and Huit Facettes in Dakar, were both formed as specific responses to: (a) the crisis of the public sphere under the long dictatorship of Mobutu Sese Seko in the former Zaire and the country's further deterioration under the late Laurent Kabila, who overthrew the Mobutu regime in 1997; (b) the erosion of the link between the state and formal institutions of culture; (c) the collapse and disappearance of the public sphere; and (d) the crisis and alienation of the labour of the artist working within the forced bifurcation of social space between the urban and rural contexts of Senegal. These responses, the first in DR Congo (formerly Zaire) and the other in Senegal, are positions specifically articulated towards the production of a common social space and the development of protocols of community as the first condition for the recognition of the sovereign subject.

It is by this insight that we can situate the work of Le Groupe Amos and Huit Facettes, especially in light of their direct engagement with the politics of crisis in African social, political, and cultural discourse in order to produce new networks that link them to local communities. Each, in its conception of the social and community, calls for evaluative procedures in the construction of a reflexive practice within their given context.

Le Groupe Amos was founded in 1989 by a group of writers, intellectuals, activists, and artists in Kinshasa. It emerged out of the political and economic crisis of the last decade of Mobutu's corrupt, dictatorial misrule, as Congolese civil society began a process of realignment and finally disintegrated into civil war. Taking its name from the biblical prophet Amos, who in the Old Testament is identified with the struggle for social justice, Le Groupe Amos initiated a grassroots activist movement that uses classic means of social aesthetics to communicate its work to the community at large. The collective evolved in the context of the changing realities in Zaire during the Mobutu regime and afterwards under the autocratic government of Kabila in DR Congo. The activities and work of the group take up methods of cultural activism that can be best seen as an extension of the tactics found in Latin American liberation theology, infusing their activism with the ethics of civil disobedience and "creative non-violent action."³⁴ As a collective, one of its principal quests was how to deal with the crisis of legitimation facing millions of disempowered Congolese silenced by the venality of two brutal regimes. In a way, there was an idealism surrounding this quest, especially when it concerns the choice to offer a different critical option to the Congolese public beyond the armed rebellion being waged against Mobutu and Kabila, in order to free the subjective force of their repressed society by means of direct action.

Four points are important in the work and conception of Le Groupe Amos. The first is its identification with the political, social, and cultural aspirations of the ordinary Congolese. This means that all its work are produced

to intervene directly in the sphere of political and social formations seeking to affect their reality. These interventions often take a didactic format and are produced both in French—the official lingua franca of the state—and in the vernacular, Lingala, the language of everyday discourse among ordinary people in Kinshasa. The second aspect of the group is its relationship to the sphere of institutional power, not only that represented by the state but also that of the church, in this case the Catholic Church. Here, the group foregrounds a critical, discursive activist relationship to the *res publica* in the conception and organisation of its projects. To do so, it translates its intellectual ideals into a series of programmatic activities (via theatre, art instruction, pamphleteering, sexual education, etc.), broadening its network among neighbourhood associations in order to organise and harness those aspirations operative in the field of power. Thirdly, the field of its actions and techniques of dissemination, production, and media (often accessible and direct, such as play using the organisation of power in a family unit to explore the underlying production of inequity within democratic systems) are carefully fused, whereby as part of the social production of the public sphere, the site of reception is also constituted as a democratic civil forum. And, fourthly, it defines its relationship to the public sphere in the manner that Antonio Gramsci defines the role of the intellectual in the context of culture. For Le Groupe Amos, this is principally formulated on the ethics of self-governance. Here the work of the intellectual is both in the activity of particular forms of praxis and in the functions that require a certain minimum intellectual

dispensation “within the general complex of social relations.”³⁵ In the field of social relations in which Le Groupe Amos has positioned its work, the targets of its actions are the state and those institutions and organisations: the church (especially the Catholic Church), political parties, rebel movements, and multinational global institutions linked to powerful economic interests. These groupings are generally regarded as complicit in suppressing the subjectivity of the Congolese people.

Working with a variety of grassroots organisations, Le Groupe Amos employs a number of devices, such as pedagogy for its projects on literacy and non-violence. With regard to politics, it uses public interventions in various media to transmit its message within the urban neighbourhoods of Kinshasa and more broadly beyond the immediate locus of the city. These interventions manifest themselves as forms of direct action targeting specific deficits within the political, social, and cultural economies. The actions can be in the form of a theatrical production organised with local actors (housewives, workers, young students), while other activities involve didactic teaching material, essays, commentaries, and cartoons published in newspapers, pamphlets, posters, and magazines. Along with these, it publishes books, teaches clinics, and organises workshops on democracy and democratisation, governance and citizenship, tolerance, civil disobedience, and gender equality. The group also produces radio broadcasts, theatre, and audio and short video documentaries, taking advantage of the endless reproducibility of the media as a way to reach communities in other parts of the vast country. Since there is no gallery system to speak

of whatsoever in Kinshasa, where Le Groupe Amos is based, this form of direct intervention into public discourse is unique and in many ways novel within its context. It is important to note that the concept of art to which the group adheres is broader than the narrowly defined aesthetic sense of art. For Le Group Amos, the tools of art are a means rather than ends in themselves. Questions raised, positions taken, debate engaged in are of greater significance than final outcomes. The work, then, is part of longer, durational process of acculturation and procedural inscription. One could rightly say that there is a proselytising dimension in the way the group employs dominant media strategies to reach a wide variety of publics in its work. The effectiveness of its practices and the level of critical respect it has received could be observed in the most recent work it is involved in, which focuses on reconciliation among the warring factions of different Congolese rebel movements. In this capacity, the members of Le Group Amos were invited as participant-observers, as one of the privileged forums of Congolese civil society, to the peace conference on the Congolese civil war hosted by the South African government in 2002 in Sun City, South Africa.

Previously, I pointed out the degree to which language plays a formidable role in the activities of the group. With a large segment of the population being illiterate, Le Groupe Amos is aware that, for its work to have a direct consequence within the field into which it intervenes, it needs to be conscious of the language of its discourse. In this case, its work maintains a critical awareness of the social and class divisions perpetuated through the mastery of the colonial

language. Its tactic is not to disavow French, which is the language of official discourse, but rather to empower the vernacular languages (e.g., Lingala, Swahili) as tools of popular discourse. In so doing, the group seeks to decapitate the class distinctions between those who occupy the space of power, and therefore are perceived as possessing discursive authority, and those on the margins of power, who lack a voice. Of the latter class, women are the most vulnerable to the distortion of the power relationships that define the chaotic and impoverished character of the Congolese public sphere. Thierry N'Landu, a professor of American literature at the University of Kinshasa and founding member of the group, describes some of their projects:

Groupe Amos's commitment to changing Congolese society through nonviolent strategies is evidenced by numerous inspirational and informative projects. In particular, Amos has focused on the plight of women in short video documentaries such *Congo aux deux visages: L'Espérance têtue d'un peuple*, 1997; *Femme Congolaise: Femmes aux mille bras*, 1997; *Au Nom de ma foi*, 1997. *Et ta violence me scul ta Femme* ("Your Violence Made me a Woman"), 1997, is a video in Lingala, a vernacular language from Kinshasa, which celebrates the power of Congolese women who struggle for rights in a context where traditions, customs, religion, and even existing laws do not facilitate equality.³⁶

Two things are noteworthy in N'Landu's statement. The first concerns the form through which

Le Groupe Amos undertakes its work as a sociocultural activity rather than specifically as a visual art activity. This would lead one to see the group's work in the broader context of knowledge production rather than in that of artistic or visual production. The effectiveness of direct communication to its audiences leads the group to pursue its work through the discursive utility of linguistic identification with each of its specific and general audiences. The second point concerns the relationship of power to the social reproduction of agency and sovereignty, particularly with regard to women. Here, specific critiques of the patriarchal structure of Congolese society are directed at the customs, traditions, and existing laws that place women in subservient positions of power. Again, the serviceability of the figure of the authentic has a far more limited purchase than the idea of the subject, insofar as the status of women is concerned in the Congolese context. This, again, is articulated as one of the stated intentions of the role of citizenship and authorship in the development of new forms of social discourse of civil society in DR Congo. José Mpundu, another member of Le Groupe Amos, in an essay on the future of democracy in DR Congo, writes:

Civil society in the situation of this crisis and in view of the resolution of the conflict will have to reconnect with its primary vocation: to educate the people in order for them to be able to take charge of themselves on all levels. Civic, political as well as moral education will make of our people the authors of their history and the masters of their destiny. Civil society is asked to play a

role of primary importance in the process of liberation of the people. ... Political liberation, economic liberation, cultural liberation, social liberation: that is the true struggle of civil society. In order to do so, it will have to help the people organize in an efficient manner and to elaborate strategies of social struggle.³⁷

Having elaborated this quasi-Marxist view of class struggle, Mpundu, a few sentences later, makes clear the idea that the liberation imagined by Le Groupe Amos is a liberation not just from the despotism of the state and its rulers (including the surrogates of Rwanda and Uganda who occupy the eastern part of the country) but also from the hegemonic power identified with European and American interests. Throughout the discourse of the crisis in Africa, the identification of the mendacity of forces of production with external powers has become deeply entrenched and not without foundation. These forces, in the name of a number of abstract concepts connected to the great liberal trinity of democracy, the free market, and human rights, are often believed to be a kind of third force that has to be fought before the sovereign African subject can emerge.

Huit Facettes was formed by a group of eight artists—hence its name—in 1996, in Dakar. It is different from Le Groupe Amos in that it is self-identified as an artist collective, using the means of art and its corollary, creativity, to probe the relationship between the aesthetic and the ethical, the social and cultural. However, the task Huit Facettes set out for itself was first a confrontation with the impotency, immobility,

and disempowerment the artists in the collective perceived in the artistic context of Senegal. The second question that concerned members of Huit Facettes was the increasing social stratification that defined the relationship between the elite and the poor in the city—a stratification that also had impoverished the relationship of their individual work to the society in which it was produced, leading it inexorably towards becoming a code for its own alienation. This stratification and alienation is even more acute in the lines that separate rural and urban communities in Senegal. In the city, the terms of dwelling and perceptions of social agency are often aleatory. While the urban economy is governed by a tendency towards informality and improvisation within the capitalist economy, the rural community is entirely tethered to a pre-industrial agrarian past. In the city, social networks that bind one community to another have not only exploded, producing scattered trajectories, but have also become implacable, diffuse, and difficult to organise. The urban material consistency, having succumbed to obsolescence, is now shaped by growing spatial distortions that collapse into fleeting temporalities.

On the vast outskirts of the urban rim, forgotten communities in the villages that are the historical link between the past and the present, the local and global, live on the edge of official amnesia; on the dark side of a politics of invisibility. Though massive in population and visible through the meagre, deracinated social amenities that can barely cope with their demands, the poor in Africa have become the disappeared of globalisation. In broad daylight, Africans are short-circuited between

development and underdevelopment, between the Third World and the First World. The poor are invisible because official discourse long ago stopped seeing them. Instead, they have become a blind spot in the neoliberal catechism of the move towards the market economy. They have become ghosts in the political machine³⁹ of late modernity. Deracinated by structural adjustment policies, the rural and urban contexts in Africa have become manifestations that produce their own structure of fecundation, a fertile soil for new possibilities of being. Urban and rural inhabitants have increasingly begun working with new kinds of experimentation, contra the logic of development modernity. They are involved in inventing new subjective identities and protocols of community.

All these issues coalesce in the activities of Huit Facettes. Its principal project since its formation is the Hamdallaye Project, a long, extended collaboration with the inhabitants of the village of Hamdallaye, some five hundred kilometres from Dakar, in the Haute Casamance region near the Gambian border. Huit Facettes perceives its work exactly as the inverse of the logic of development strategies through the utility of art. In so doing, its central mission has been to "disentangle modernism's historical contradiction between art's claim to aesthetic autonomy and its ambitions for social relevance."⁴⁰ The sustained ongoing project at Hamdallaye attempts, through collaboration between the members of the group and the villagers, to concentrate not only on the circulation of the symbolic goods of artistic skills but also on the strategic transfer of vital skills from the artists to the village community. However, this transfer of

skills is directed to ensure that the villagers retain creative control of their artistic labour. To empower the isolated villagers, and thereby increase their economic capacity through artistic skills, not only profits the villagers, but it also helps them bridge the social distance between themselves as artists and the villagers who perceive artists from the point of view of being a privileged urban elite identified with elements of the state. According to Kan-Si, one of the founding members:

Huit Facettes in rural Senegal is much more the story of a procedure or process which, as it unfolds, has given us (contemporary Senegalese artists living in the city) a point of anchorage or reconciliation with the part of society that feeds us and from which we were cut off. One particular elite rejoins its roots in the same sociocultural (Senegalese) context.⁴¹

Each year in Hamdallaye since 1996, the project with the villagers begins with a series of public discussions that then move into the phase of workshops. Each workshop is designed to transform basic skills into professional skills, for example in under-glass painting, ceramics, batik dyeing, carving, weaving, embroidery. Depending of the level of work needed to accomplish the training at hand, the workshops are normally conducted over a period of one to two weeks. The concentration on specific kinds of skills is arrived at based on both their utility and their creativity. But also on dialogue with members of the community. Women are especially targeted as a group who can profit from the link with the artists.

For Huit Facettes, the arrival at what to do in each workshop is connected to the utility of certain creative systems (they have to be accessible, inexpensive, skilful, sustainable over a long period, and draw from the exchange of knowledge between the two groups). What the artists offer, in addition, is access to material, advertisement of the results and access to the urban market. Above all, the autonomy of the Hamdallaye residents in deciding what is most useful for them in the collaboration is important for the critical discourse of Huit Facettes. The group tries to avoid the hierarchical structure of NGO development work. This is partly to stimulate the agency and subjective capacity of each participant in the workshop, to help them establish an individual expression. But above all it is to avoid at all costs the possibility of dependency. By paying critical attention to the idea of subjectivity, Huit Facettes works in the interstices of development and empowerment, whereby "in the end the participants are able to set up self-sustaining practices as non-dependent citizens."⁴²

This approach is attempted as a subtle contradiction of the development discourse, which recently has been the dominant vehicle for addressing many African crises. The top-down, donor-client model of NGOs and development agencies based in wealthy Western countries have been perceived as undermining Africa's ability to be non-dependent. Oftentimes, development organisations, through donor institutions, operate on the assumption of economic and sociopolitical templates that can be domesticated within an African context—transforming the templates, as it were, into substrates of an authentically African ideal. As such,

there is a preponderance of support for an aesthetic of recycling, the make-do, makeshift, and bricolage, rather than invention, sophistication, and the technologically sound transfer of knowledge.⁴³ In short, development has given rise to the spectacle and excess of *Tokunbo* culture,⁴⁴ whereby discarded and semifunctional technological objects and detritus of the West are recalibrated for the African market. From used cars to electronics, from biotechnology to hazardous waste, Africa has become the dumping and testing ground for both extinct Western technologies and the West's waste.⁴⁵ All these issues come up in Huit Facettes' analysis of the political-social-cultural economy of Senegal.

On a certain level, this approach may in certain quarters be perceived as naive. However, Huit Facettes is under no illusion that its work makes any difference beyond its ability to establish a particular type of social context for communication between itself and different communities in Senegal. One example is its work on health, particularly the campaign to raise public awareness on the AIDS pandemic, for which the work it produced included a hip-hop concert on the subject. Different members of the group were also involved as participants, as individual artists, in the multidisciplinary urban renewal project called *Set Setal* during the early 1990s in Dakar. The conception of art on the basis of activism is one on which its statements have been soundly equivocal. There is no over-determined claim for the emancipatory capacity of art. Like *Le Groupe Amos's*, art of the kind that Huit Facettes proposes in the name of actualising a community is a means in the process of coming together in a discursive as

well as a cultural recognition, rather than an end towards consecration of artistic talent alone. According to Kan-Si, in the view of Huit Facettes:

Artistic work that aspires to engage with social issues ... contributes in one way or another to the development of the "real world," only much will depend on the nature of that work. Such contribution will have to be perceived differently and in a wider sense, just as the notion of a work of art can be understood more in terms of process than as finished cultural object, to be instantly consumed (seen, appreciated or indeed judged). Society's concerns become the medium for an intervention, if only suggestively, for a formula through which we may engage with and seek solutions to problems encountered in everyday life.⁴⁶

This statement demonstrates the group's inclination to treat sceptically any notion that art of the kind it is involved in ought to supply surplus value as cultural products that can be consumed, collected, and classified.

By forcing themselves to confront the incommensurable in the relationship between the ethical and the aesthetic, between the subject and the state, Huit Facettes and Le Groupe Amos operate in the vanguard position of a new type of debate within the contemporary African public sphere. As we know, all activities, events, and practices of art are grounded in specific paradigm formations; that is, all activities, events, and practices of art are

determined by a history and the structure of the formation of that history. It is also important not to analyse the complex manifestation of this practice from the perspective of an aesthetics of political action, which, today, is not only problematic but has increased the dialectical tension between notions of ethics and aesthetics. Whether it is possible to address ethical questions through the vehicle of aesthetics seems, for now, not only overdetermined but also subject to deep ideological appropriation by both liberal and conservative forces. In fact, the combination of the political and the poetic, the aesthetic and the ethical, have often led to an unhappy conflation of power and morality.

Consequently, the conjunction of ethics and aesthetics in certain forms of institutional critique have tended to view artistic practice through the lens of a simplistic analysis of politics (between good and bad, proper and improper, virtuous and cynical), rather than through the more critical notion of the political, which, to my mind, grounds all relations of power and discourses between artists, activists, and institutions. Ethics today has a high currency in the field of contemporary art, all the more so because of the kinds of surprising prohibition placed on the political in relation to art.⁴⁷ Contemporary discourses in many areas—be it in the conduct of war (the adherence to or violation of the Geneva Conventions); medicine (euthanasia and abortion being two examples); biotechnology (the recent debates around the ethics of cloning); law (capital punishment); or human rights (child labour, slavery, racism—have engaged further explorations of the ethical as that which sutures

certain complex conducts into the political, scientific, and cultural spheres. And here artists have been at the forefront of an interdisciplinary response to the debates that have grown out of them. However, the relations between the ethical and the aesthetic, the aesthetic and the political, and the poetic and the social have increasingly brought the philosophical discourse and moral

force of ethics before us in an unresolved form. This is where I believe the discourse of "authenticity," as the force that gives positive content to the work of the African artist, is not only misguided but deeply problematic. Therefore, to understand that which animates the world view of the African artist, we must do well to invent a new politics of the subject.

- 1 Walter Benjamin, "The Author as Producer," in *Reflections: Essays, Aphorisms, Autobiographical Writings*, ed. Peter Demetz (New York: Schocken Books, 1978), 221.
- 2 Benjamin, "The Author as Producer," 221.
- 3 Benjamin, "The Author as Producer," 222.
- 4 Georg Lukács, "Tendency or Partisanship?," in *Essays on Realism*, ed. Rodney Livingstone, trans. David Fernbach (Cambridge, MA: MIT Press, 1980).
- 5 I borrow this term from the perceptive essay by David Deitcher, "Social Aesthetics," in *Democracy: A Project by Group Material*, ed. Brian Wallis (Seattle: Bay, 1990), 12–3.
- 6 Lukács, "Tendency or Partisanship?," 35.
- 7 Lukács, "Tendency or Partisanship?," 35.
- 8 In a famous statement, Joseph Beuys provocatively proclaimed the point of view that "everything is art" and therefore "everyone is an artist." Such a judgement no doubt can be equally conceived as part of the hubristic simplification some critics often associate Beuys with.
- 9 In an essay written after World War II, Jean-Paul Sartre asked this question. See Jean-Paul Sartre, "What Is Literature?," in *What Is Literature? and Other Essays* (Cambridge MA: Harvard University Press, 1988).
- 10 In an interview in the *Guardian* published October 31, 2002, Howells described the work of the artists thus: "If this is the best British artists can produce then British art is lost. It is cold, mechanical, conceptual bullshit." Martin Creed is the artist who presented an installation of lights going on and off in one of the galleries of Tate Modern, London, as part of his presentation for the Turner Prize, and was especially marked out for excoriation. Suffice it to say that the minister's reaction was not so much about the work as much as it was about a prestigious award being conferred on something that displays a minimum of artistic originality or labor.
- 11 Rosalind Krauss, *The Originality of the Avant-Garde and Other Modernist Myths* (Cambridge, MA: MIT Press, 1985).
- 12 Walter Benjamin, "The Work of Art in the Age of Mechanical Production," in *Illuminations: Walter Benjamin Essays and Reflections*, ed. Hannah Arendt (New York: Schocken Books, 1969) has remained a classic essay and the most penetrating analysis of the

contingency of the nature of aura as what determines the uniqueness in the work of art. The transfer from uniqueness to reproduction inherently marks the end of the idea of aura to the extent that the question of the nature of art was concerned.

13 Thierry de Duve, *Kant after Duchamp* (Cambridge: MIT Press, 1996).

14 See Joseph Kosuth, *Art after Philosophy and After: Collected Writings, 1966–1990*, ed. Gabriele Guercio (Cambridge: MIT Press, 1991).

15 Walter Benjamin, "The Author as Producer," 229.

16 Benjamin Buchloh, "Conceptual Art 1962–1969: From the Aesthetic of Administration to the Critique of Institutions," in *October: The Second Decade*, ed. Rosalind Krauss, Annette Michelson, Hal Foster, Benjamin Buchloh, and Silvia Kowbolski (Cambridge: MIT Press, 1996), 119.

17 Frantz Fanon, *Black Skin, White Masks*, trans. Charles Lam Markham (New York: Grove, 1967), 17.

18 Fanon, *Black Skin, White Masks*, 17.

19 See Sydney Kasfir, "African Art and Authenticity: A Text with a Shadow," in *Reading the Contemporary: African Art from Theory to the Marketplace*, ed. Okwui Enwezor and Olu Oguibe (London: INIVA—Institute for International Visual Arts; Cambridge, MA: MIT Press, 1999), 88–113.

20 See, for example, Soyinka's critique of Négritude in Wole Soyinka, *Myth, Literature and the African World* (Cambridge: Cambridge University Press, 1976).

21 See Michael Taussig, *Mimesis and Alterity: A Particular History of the Senses* (London: Routledge, 1993).

22 Yinka Shonibare and Chris Ofili are but two of the most well-known African artists who have made the critique of authenticity central to their work. In the case of Shonibare, he has used the idea of excess as a strategy to undercut the power of the authentic as a marker of cheapness and lack of sophistication.

23 See Achille Mbembe and Janet Roitman, "Figures of the Subject in Times of Crisis," *Public Culture* 7, no. 2, (1995): 323–52.

24 Achille Mbembe, *On the Postcolony* (Berkeley: University of California Press, 2001), 10.

25 Sydney Kasfir has made the important observation of the fact that questions of authenticity of African art were first a value of connoisseurship of the Western collector, for whom the importance of authenticity depended on the establishment of what is valued as fake and what is not valued as a copy or a fake. Therefore, the science of authentication is not more than a fantasy of projection through the construction of "tribal style," whereby "authenticity as an ideology of collection and display creates an aura of cultural truth around certain types of African art (mainly precolonial and sculptural)." Kasfir, "African Art and Authenticity: A Text with a Shadow," 98.

26 Mbembe, *On the Postcolony*, 6. Emphases in the original.

27 Throughout, I have pivoted my idea of crisis around Mbembe and Roitman's exceedingly important text "Figures of the Subject in Times of Crisis."

28 Michel Foucault, "21 January 1976," in *Society Must Be Defended: Lectures at college de France, 1975–1976*, ed. Mauro Bertani and Alessandro Fontana, trans. David Macey (New York: Picador, 2003), 43.

29 In 1934, during an address to the Institute for the Study of Fascism in Paris, Benjamin raised the issue of the “author as producer.” His insights made nearly seventy years ago remain remarkably prescient even today. Under the threat of the looming political crisis in Europe at the dawn of fascism, Benjamin averred that the context of production—here he was speaking specifically about literature—must be set in a “living social context” namely the social context of production. Conversely he observed that “social conditions are ... determined by conditions of production. And when a work was criticized from a materialist point of view, it was customary to ask how this work stood vis-a-vis the social relations of production of its time.” The second point made by Benjamin in this direction is: “Rather than asking, ‘what is the attitude of a work to the relations of production of its time?’ I would like to ask ‘What is its position *in* them?’ This question directly concerns the function the work has within the literary [artistic] relations of production of its time” (original emphases). Walter Benjamin, “The Author as Producer,” 222.

30 See also Frantz Fanon, “On National Culture” in *The Wretched of the Earth*, trans. Constance Farrington (New York: Grove; Paris: Présence Africaine, 1963). On the role of intellectuals in the postcolonial emancipatory project, see also Sekou Touré, “The Political Leader as a Representative of his Culture,” in *Expérience Guinéenne Unité* (Paris: Présence Africaine, 1962).

31 See Joseph Stiglitz, *Globalization and Its Discontents* (New York: W.W. Norton, 2002), Stiglitz being one of the more prominent critics of the World Bank and IMF.

32 Foucault, “21 January 1976,” 43.

33 A typical response throughout the onset of the crisis is attempts at delegitimizing the artist and intellectual, forcing many into prison, dissidency, or exile, as in the case of Nigeria during the period of political repression by the Abacha regime. When artists and intellectuals are forced to go to exile, many experience an anxiety of the authenticity of their work.

34 Thierry N’Landu, “Le Groupe Amos” in *Documenta11, Platform 5: Ausstellung/Exhibition, Kurzfiihrer/Short Guide* (Stuttgart: Hatje Cantz, 2002), 102.

35 Antonio Gramsci, *An Antonio Gramsci Reader: Selected Writings, 1916–1935*, ed. David Forgacs (New York: Schocken Books, 1988), 304.

36 See the introduction to *Le Groupe Amos: Reader*, a compilation of writings of the group (translated into English by Muna El Fitri-Enwezor) presented as part of a reading and media room dedicated to the group’s work at *Documenta11, Platform 5*, Kassel, Germany, June–September 2002.

37 José Mpundu, “What Future for the Democratic Republic of Congo?,” in *Le Groupe Amos: Reader*, 148.

38 AbdouMaliq Simone, “The Visible and Invisible: Remaking African Cities,” in *Under Siege: Four African Cities—Freetown, Johannesburg, Kinshasa, Lagos*, ed. Okwui Enwezor, Carlos Basualdo, Ute Meta Bauer, Susanne Ghez, Sarat Maharaj, Mark Nash, and Octavio Zaya (Stuttgart: Hatje Cantz, 2002).

39 Simone, “The Visible and Invisible.”

40 Nadja Rottner, “Huit Facettes,” in *Documenta11, Platform 5: Ausstellung/Exhibition, Kurzfiihrer/Short Guide*, 114.

- 41 Kan-Si, "Dimensions Variable: Reply from Kan-Si," in *Metronome*, nos. 4–6 (1999): 126.
- 42 Huit Facettes, exhibition statement, Documenta11, Kassel, Germany, June–September 2002.
- 43 Artists such as Georges Adéagbo, Kay Hassan, António Ole, Romauld Hazoumé, and Pascale Marthine Tayou have thoroughly dismantled the randomness and poverty of the bricolage aesthetic by elaborating new sculptural and pictorial devices with recycled material: Ole with his painterly and monumental refabrications of urban architectural fragments; Adéagbo with his mnemonic recontextualisations of archives of colonial and postcolonial history in his sculptural and sign-painting appropriations; and Hassan with his arresting collages of masks, portraits, and crowds fabricated out of torn surplus billboard advertising prints that manifest an unusually raw fetishistic power. Hazoumé's plastic masks fashioned out of cutout plastic jerry cans, on the other hand, reside uneasily between genuine sculptural experiments and Afro-kitsch. The larger and more critical question is why has the bricolage aesthetic persisted for so long all across Africa, and in fact seem to be acquiring an even greater acceptance in the work of even younger artists? The upshot is that, for some reason, recycling as an aesthetic option strangely continues to be seen by many artists as a proper artistic choice for making art. This, perhaps, is owed to the erroneous notion that using recycled, impoverished material in clever ways somehow transform and elevates the assembled oddities into innovative, albeit uncanny, artistic products that raise local curiosity and please benevolent development workers.
- 44 *Tokunbo* is a Yoruba term that literally means "second child," but in the typical wry humor that accompanies responses to bleak socioeconomic conditions in most African countries, the term has come to stand for the vast second-hand market of Western technological products such as cars, computers, electronics, and assorted machines that have been *reconditioned* and made *suitable* for export to Africa. The scale of the *Tokunbo* trade far outstrips that in new technological products and increasingly has come under state scrutiny for the effects on the environment, productivity, and safety.
- 45 In fact, it seems unimaginable that there could be any other reason for this response to second-hand, recycled commodity-fetish products of the developed world beyond the survivalist strategies of people caught in the grips of brutal global economic restructuring. It is also to such survivalist strategies that artists and intellectuals have turned in order to protect their autonomy as critical producers of culture.
- 46 Kan-Si, "Dimensions Variable," 122.
- 47 A number of the critiques that accompanied the reception of Documenta11, which devoted a significant part of the exhibition to exploring the relationship between representation and the domain of social life, were based on abjuring the political and ethical in the conception of the work of art. Typical of such responses were criticisms from neoconservative writers such as Michael Kimmelman of the *New York Times*, Blake Gopnik of the *Washington Post*, and Christopher Knight of the *Los Angeles Times*.

Kasbah Walking III,
Taking Photographs and
Making Embroidery

10

Hans Hamid Rasmussen

2017

First I'd like to especially say, thank you for being asked to take part in the anniversary celebration of Malmö Art Academy. I can state that I would not be the artist I am without the environment for thinking that the Academy, with its excellent teachers and staff, has built up.

My contribution to the celebration comes in the form of a text titled "Kasbah Walking III, Taking Photographs and Making Embroidery." The text was previously published in the catalogue for the project *World Wide Weaving—Atlas: Weaving Globally, Metaphorically and Locally*, conceived and curated by Dorothee Albrecht and I in 2017, and published by KHiO—Oslo National Academy of the Arts.

The title of this essay came about as a result of a letter from Sarat Maharaj, Professor in Visual Art and Knowledge Systems at the Academy, with advice and help in understanding important critical issues related to my research project. He asked me: Did I understand that, among other things, relation itself represents a potentiality of real space?

In my role as a professor in the Art and Craft department at KHiO, from 2008 to 2020, I have tried to bring in the learning culture that was first conveyed to me by Malmö Art Academy Rector Gertrud Sandqvist more than two decades ago. The project *World Wide Weaving* was developed together with Dorothee Albrecht for textile students at KHiO, and it included important contributions from both Maharaj and Sandqvist and much inspiration from the learning culture that makes Malmö Art Academy such an important institution.

Kasbah Walking III, Taking Photographs and Making Embroidery

During the past years, Europeans have intensively dealt with issues related to refugees and immigration, due to the wars in both Afghanistan and Syria. But there are also people seeking safety and better living conditions who are from elsewhere in Africa and are arriving in Europe with transit through Libya, Algeria, and Morocco. I will not go into this large topic, with the exception of mentioning that my family also once arrived in Europe as refugees, fleeing from a coup d'état in Algeria in 1965. We rested in Budapest for one year. Then we moved on to Norway, while my father made his way to Paris. For my sister and me, the flight was easier because our mother is Norwegian. This happened in the late 1960s, early 1970s. During that time, Scandinavia was still in a mode of openness. To be more specific,

the farmer's area where I grew up was a rather friendly and peaceful place to arrive at. Still, like most strangers, I have experienced what it means to be alienated both geographically and socially. Even after living in Norway for many years, I still experience and keep within me the knowledge of what is different.

The philosopher Paul Ricœur states that, on the one side, what we forget and what we remember is a result of an active cognitive process. But what becomes history and what we share with others results from a shared critical process, which then slowly develops into what becomes a collective memory. Shared memories are constructed in close relation to geography—places in landscape and cities, the names we give places—and also immaterial shared knowledge, such as myths and fairy tales.

During my second trip to Algiers in 2007, together with my brother Karim and my father Boualem Makouf, I met relatives living in the Kasbah. A “kasbah” is etymologically understood as a fortress. The form of the street and colours used on the facades are meant to cause dis-orientation.

Any enemies had to split up into thinner lines or smaller groups, which then were easier to attack. The French used to call the Kasbah in Algiers *la ville blanche*. In the film *La Bataille d'Alger* from 1966, we learn how the French Army developed new systematic methods to penetrate resistance movements such as the FLN. As a matter of fact, with tremendous force—napalm and electrical torture and the systematic repression of civil people—the oppressor could penetrate a resistant social body living in the country as well as in the complex city structure of the Kasbah.

When I took walks in the Kasbah, I was aware of this history and reflected on it. This history

was passed over from my father and is entangled into family matters. He told me: "When I was tortured by the French, it was bearable because I knew the earth under me was of my own. It gave me the strength to endure. in prison after the coup, when my own people tortured me, it was as if the earth disappeared."

Boualem Makoufs commitment to establishing an international socialism based on Marxism could not find a future in a state like the one Algeria had become. He went into exile to Paris, where he became politically active, in close relation to art in many forms.

In the Kasbah, the shifting social conditions have also formed the city. The steps we walk up and down respond to shifting political and social circumstances. I write "we," because there are so many people who carry with them past experiences of violence. Well after moving or fleeing to new social and geographical conditions, a large gap exists between an inner memory, or a memory we share with a few, and a collective memory. Memories can be contained in the smell of a flower or in the sight of a familiar bird and the songs it sings. But more important for our living conditions is how we are able to transport and translate our memories from past into present situations. When walking in the Kasbah, I feel connected to historical time, to periods of long duration like the time of French colonialism, to air strikes and bombings and the National Liberation Front's (FLN) response to this. I feel the repercussions of the civil war at the end of 1990s, but also of earthquakes that caused damage to buildings and street structures. In a strange way, the present city structure reflects the past of many Algerians. I believe refugees around the world have similar experiences. Walking in the Kasbah weaves together the past and the present, as well as interlinked geographical references.

Image pp. 178–179:
Kasbah, November 11, 2009. Image courtesy of the artist





We Are Each Other's Air

11

Övül Ö. Durmusoglu

2019

This text is an amended version of an essay that accompanied Runo Lagomarsino's exhibition *We are each other's air* at gallery Francesca Minini, Milan, in July 2019.

Reprinted by permission of the author and Runo Lagomarsino. Lagomarsino graduated from the MFA programme at Malmö Art Academy in 2003.

"We need other kinds of stories," says Donna Haraway as she faces the camera in Fabrizio Terranova's *Storytelling for Earthly Survival* (2016) and then suggests a wide horizon of possibilities about how these other stories may feel, look, or sound like. To balance our earthly living, weak stories are to be rendered strong while dominant stories are to be rendered weak. Runo Lagomarsino's practice is woven around a strong need for other kinds of stories shaped by persisting presence in the face of dominant narratives of power. From the beginning of our conversation, I followed how this desire unfolds itself in different forms and processes. And our conversation began at a critical turning point, when Runo was finishing his Master of Fine Art at Malmö Art Academy and when I was starting a new journey as part of the school's Critical Studies postgraduate programme, led by Simon Sheikh. It has been almost fifteen years since, and we continue to converse and collaborate thanks to the formal and political issues we both care about—ways to create other kinds of stories and circulate them.

Runo is very aware of how language is a site of empowerment and a site of enslavement at the same time. In his approach, materialities become tools and environments of storytelling; they are transformed with frictions such as the dilemma of presence and the impossibility of containment. He has recently been experimenting more with containment in various forms and elements, collapsing the boundaries between materiality and immateriality in different realms of politics and poetics.

The Enlightenment, defined as the Age of Reason in Europe, advocated ideals such as liberty, progress, tolerance, constitutional government, and the separation of church and state, and it produced the basis of modernity as it is understood today. For the artist, modernity and its ideals, as erected through the domination of labour, wealth, and resources appropriated from colonised lands and communities, reduces the knowledge and reality of the worlds we live in to a singular dominant narrative. The sharp and idiosyncratic sense of humour cross-referencing double-faced stories of modernity has acquired even more responsibility these days, when we are acutely experiencing the collapse of modernity—a multifaceted hegemonic project that we are all part of in different ways.

Runo often fractures and plays with the historical narrative of enlightenment, which appears in the materiality and symbolism of both natural and artificial light in works such as *Trans-Atlantic* (2010–11), for which he had newspapers regularly exposed to sun during transatlantic sea travel; *Stolen Light (Abstracto en Dorado)* (2013), a display of stolen light bulbs and neons he took from the Ethnological Museum in Berlin; and *A Place in Things* (2014), in which he reunites more than one hundred lighting devices previously used in the Pergamon Museum in Berlin, systematically laid out on a plinth. Communities today resist the further stealing of light, the further extraction of resources from south to north, the narratives erasing the effects of centuries-long extraction.

One such example of resistance is taking place very close to the Museum Island of Berlin, specifically around the newly constructed Humboldt Forum, which incorporates the same Ethnological Museum that Runo worked around, with its collections from Africa, Asia, the Americas, and Oceania, as well as the Museum of Asian Art. Rather than working to address the violent histories behind these collections, the Humboldt Forum project is moving in the exact opposite direction: to house these objects, it has revived a fifteenth-century palace charged with the symbolism of the Prussian monarchy, Christian dominance, and colonial entitlement. The Coalition of Cultural Workers Against the Humboldt Forum is addressing this proposal in the centre of the city, which is outrageous at a time when monuments to racist, colonial violence are being removed in very visible ways around the world.

Poet and philosopher Édouard Glissant rightfully points out that, from the perspective of enlightened Western thought, understanding people and ideas requires being measured and reduced: “In order to understand and thus accept you, I have to measure your solidity with the ideal scale providing me with grounds to make comparisons and, perhaps, judgments. I have to reduce.”¹ When there is reduction, there is no relation. Yet Runo’s playful reduction of enlightenment to light bulb and its artificial light reveals the reductive Western perspective in relation to the rest of the world, as exemplified in the Humboldt Forum project and similar others in the Western sphere, and relates history with the contemporary in intrinsic ways.

We live on the ruins of previous futures (2015–19) is the next passage in another kind of story. Comprised of glass jars and burned and broken light bulbs collected from the apartments that the artist and his family have lived in over the last four years in different countries and continents, the work brings the same institution of enlightenment into the domestic space, addressing what ideologically connects the institutional sublime and the everyday mundane. In putting used, burned, and broken light bulbs into jars, Runo alludes to the process of demystification and remystification present in *Lampada annuale* (1966) by one of his reference artists, Alighiero Boetti, in which a single, oversized light bulb, set inside a mirror-lined wooden box, randomly switches on for eleven seconds each year. Runo’s work is also a poetic call to accountability, to be aware of how many natural balances—and therefore previous futures—are destroyed in order to safely burn that light bulb in that domestic space. Rather than inflicting guilt, this call suggests that we should embrace awareness with care.

There is another side of the coin. The “coloniality of power” is a recurring condition in contemporary Latin American societies, which shapes the living legacy of colonialism in the form of social discrimination and political interventionism. This concept was introduced by the Peruvian sociologist Anibal Quijano and further argued by the Argentinian semiotician Walter D’Mignolo—another figure who inspires Runo’s engagement with the question of modernity. D’Mignolo writes:

“Modernity” is a European narrative that hides its darker side, “coloniality.” Coloniality, in other words, is constitutive of modernity—there is no modernity without coloniality. Hence, today the common expression “global modernities” imply “global colonialities” in the precise sense that the colonial matrix of power (coloniality, for short) is being disputed by many contenders: if there cannot be modernity without coloniality, there cannot be either global modernities without global colonialities. That is the logic of the polycentric capitalist world of today.²

Coming from a family forced to migrate to Argentina from Italy before the heat of colonialist World War I caught fire, and then forced to leave Argentina when the military dictatorship came to power in 1976, next coming to Sweden, Runo is very aware of the forms of fascism that the colonial mind is produced by and continues to produce to sustain itself. The current Bolsonaro government in Brazil, where Runo partially continues to live with his family, as representative of a new generation of anti-establishment alt-right movements, is one reflection of this condition. This coloniality brutally shows itself not only in Jair Bolsonaro's endangering of the whole country through his refusal to deal with the COVID-19 crisis, but also in his attempts at genocide by cutting off water resources to Indigenous communities in such a critical moment when the country and world is attempting to survive a pandemic.

When Richard Serra made his famous *Hand Catching Lead* film in 1968, inspired by Yvonne Rainer's *Hand Movie* (1967–68) which shows finger exercises, the art critic Rosalind Krauss framed the hand in action—trying, failing, and trying again to get hold of material in a repetitive cycle—as being a gesture of self-reflection and self-reference. The question of how art histories are written, by whom, and for whom comes forward in Runo's own "hand film" *America I use your name in vain* (2019). What kinds of models does Western modern art history propose to artists who are shaped by different contexts of power? The iconic hand of a minimalist artist claiming its material humorously translates into the precarious hand of an artist trying to hold the inner metal circle of 1 Brazilian real, one of the slipperiest currencies in the world, demanding self-reflection from those who write art histories. At the same time, the film can be read as a condition report of the ongoing loss of resources in colonised lands from the deep past up until today. And it points out how these two issues need to be read in relation, rather than treated as separate situations in reduction.

"I first try to see what is behind the image," Runo says. He knows that the world is the kind of place where we live among alien gods with weapons of magic, as a Navajo protection song says. His nomadic wisdom shaped between South and North, across continents and oceans, and in relation to political disruptions caused by dominant narratives, is built on the intuition that what is claimed to be contained can never actually be contained. He generously invites the audience to imagine together using the material and immaterial voids he deliberately leaves behind. Runo's stories will always be of the other kind.

1 Édouard Glissant, *Poetics of Relation*, trans. Betsy Wing (Ann Arbor: University of Michigan Press, 1997), 190.

2 Walter D. Mignolo, *Coloniality: The Darker Side of Modernity* (Durham, NC: Duke University Press, 2011), 39.

Image pp. 186–187:

Runo Lagomarsino, *Stolen Light (Abstracto en Dorado)*, 2013. Composition gold leaf applied to the wall, cabinet with lightbulbs, and neon tubes stolen from the Ethnological Museum, Berlin. Variable dimensions. Courtesy of Collection Ignacio Liprandi, Buenos Aires. Image courtesy of Gustavo Lowry

Image pp. 188–189:

Runo Lagomarsino, *Pergamon (A Place in Things)*, 2014. Incandescent bulbs, fluorescent tubes, halogen lamps and other light devices from the Pergamon Museum, Berlin. 500 x 600 x 75 cm. Courtesy of Collection Teixeira de Freitas, Lisbon. Image courtesy of Erling Lykke Jeppesen

Image pp. 190–191:

Runo Lagomarsino, *We live on the ruins of previous futures*, 2015–19. Burned light bulbs collected in the artist's apartments, and glass jars. Variable dimensions. Courtesy of the artist and Francesca Minini, Milan. Image courtesy of Andrea Rossetti













Image pp. 194–195:

The Anti-Apartheid Room at Malmö Art Academy, 2017. Reconstruction by Sebastião Borges, Ellinor Lager, Max Ockborn, Joana Pereira, and Joakim Sandqvist. Image courtesy of Joakim Sandqvist

Image pp. 196–197:

The Art History Room at Salisbury Island, University of South Africa, University College in Durban for Blacks of Indian Origin, circa 1971. Courtesy of The Documentation Centre, University of Kwa-Zulu-Natal at Durban Westville

Image pp. 198–199:

The Art History Room at Salisbury Island, University of South Africa, University College in Durban for Blacks of Indian Origin, circa 1971. Detailed documentation. Courtesy of The Documentation Centre, University of Kwa-Zulu-Natal at Durban Westville. During the highpoint of the Apartheid years, a new campus was built (1972) and University College, Durban for Blacks of Indian Origin was renamed: University of Durban-Westville for Indians. After the Apartheid years, the above institution was de-segregated and merged with the other segregated universities for the Zulu and for Whites, creating the post-Apartheid, multiracial university renamed University of Kwa-Zulu-Natal at Durban Westville

Image p. 200:

The Anti-Apartheid Room at Malmö Art Academy, 2017. Detail. Reconstruction by Sebastião Borges, Ellinor Lager, Max Ockborn, Joana Pereira, and Joakim Sandqvist. Image courtesy of Joakim Sandqvist

The World Turned Upside Down:
Art and Ethics in the Rise of
the "Stone Age South"

2017

Sebastião Borges
Ellinor Lager
Max Ockborn
Joana Pereira
Joakim Sandqvist
and Sarat Maharaj

During the 2017 spring semester, the course "The World Turned Upside Down: Art and Ethics in the Rise of the 'Stone Age South,'" initiated by Professor Sarat Maharaj, took place at Malmö Art Academy.

The starting point for the project was a reconstruction of the Art History Room (AH Room) in Durban, South Africa, of the apartheid years. The AH Room was located at the University of South Africa, University College in Durban for Blacks of Indian Origin. The reconstructed room in Malmö, given the title the Anti-Apartheid Room, served as the backdrop for all events that took place during the course. These included a number of open lectures by speakers from around the world, covering the various themes of the course: migration, colonialism, cosmic awakening, women in historical accounts of apartheid, and the decolonisation of knowledge production.

Documentation of the reconstruction, which was done by the artists and then students Sebastião Borges, Ellinor Lager, Max Ockborn, Joana Pereira, and Joakim Sandqvist, is here included together with a text by Sarat Maharaj.

Among the guest lecturers were Jan Apel, Jürgen Bock, Hans Carlsson, Franco Farinelli, Ângela Ferreira, Ndikhumbule Ngqinambi, Paul Gilroy, Betty Govinden, Thomas Higham, Jakob Jakobsen, Runo Lagomarsino, Patricia Lorenzini, Manuela Ribeiro Sanches, Arathi Sriprakash, Julia Willén, and from the Faculty Margot Edström, Mats Leiderstam, Sarat Maharaj, Gertrud Sandqvist, Emily Wardill.







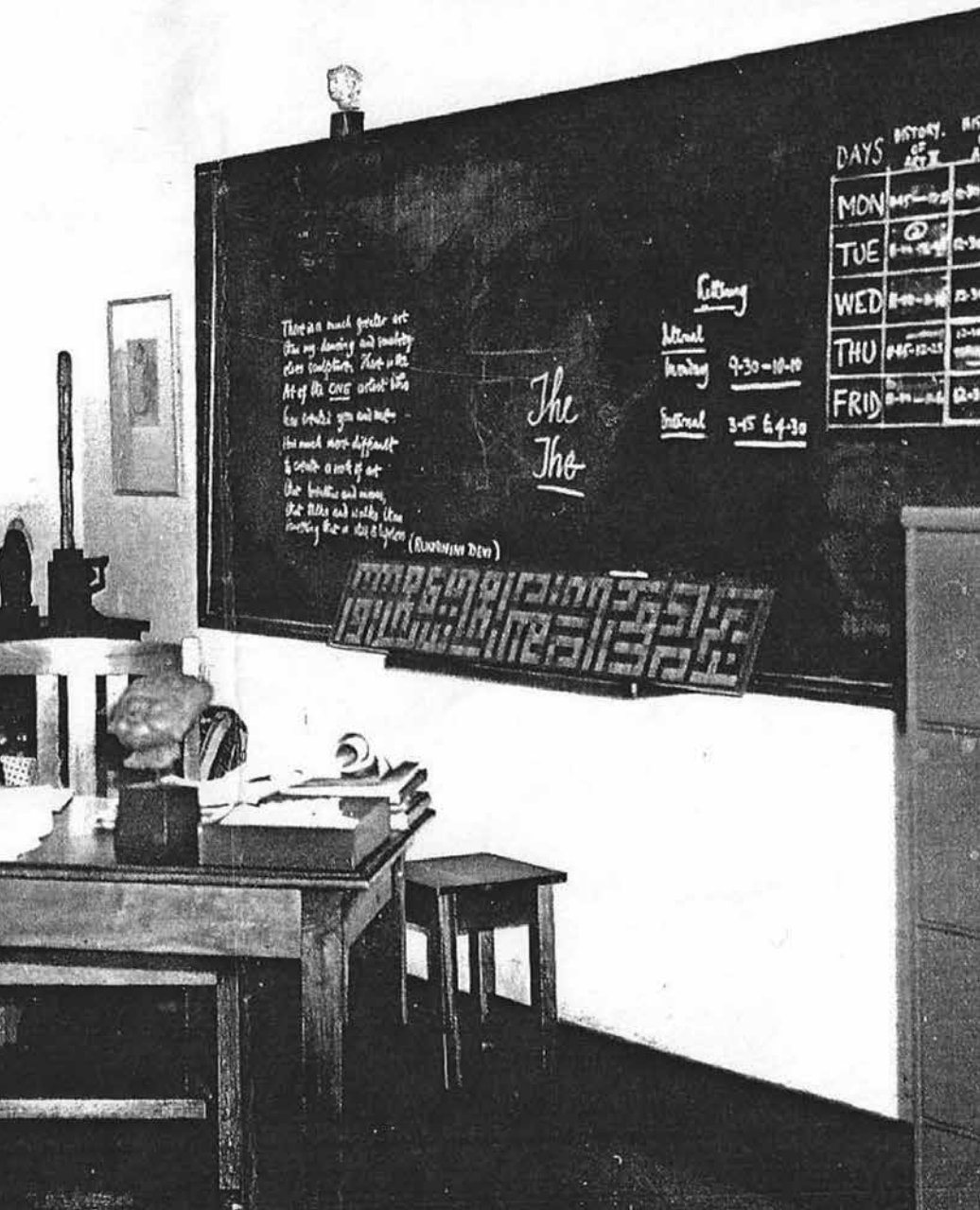

There are much greater art
 than my drawing and sculpture
 class sculpture. There is the
 Art of the CVE artist like
 the Greek you will meet
 the most most different
 to each a sort of art
 the British and more
 the style and really like
 having the a lot of styles
 (Rudolf W. Dier)

The
The

History

Literal

Reading

9-30-10-10

Internal

3-45 4-4-30

DAYS	HISTORY	ART
MON	9-10-10	10-10
TUE	10-10-10	10-10
WED	10-10-10	10-10
THU	10-10-10	10-10
FRID	10-10-10	10-10



7 20 2 18 10 11 12 19 23



24 25 1



Documentation Centre

University of Durban-Westville

Accession No: 1152/470
 Collection: Van Nickerk
 Description: Prof C Lakhi
 History of Arts Salisbury Island

- 1 Whitewashed interior
- 2 Breugel, *The Wedding Feast*, oil, ca 1567, photo/repro?
Northern Renaissance,
Flemish, retinal
- 3 Tannoy and/or listening device?
- 4 Through the window, a hovering moiré of heat vapour over the tarmac. A railway line cuts across the grass. Wagonloads of prisoners in khaki
- 5 Whirr of ceiling fan. Spy cam?
- 6 Brown, wicker weave or leather strap chair
- 7 White marble bust, repro,
Greco-Roman-Hellenistic
- 8 Smoky mustard stone,
repro Aztec Head
- 9 Elongated figurine, polished ebony, Congo
- 10 Four South African burnt black pieces,
Ndebele, Xhosa, Venda, Sotho
- 11 Elongated figurine, Makonde,
Tanzania
- 12 Baigneuse, pastel
- 13 Rubbing, Khoisan stone engraving, prehistoric, Transvaal
- 14 Craft ware, sooty clay pot,
KwaZulu
- 15 Haptic vs. Eidetic
- 16 Wool rug, Rorke's Drift Mission
- 17 Waste paper bin. Snooper?
- 18 Woman in silk sari at Luxor or Madurai, framed family photo, black & white
- 19 Scholarly papers, ping of Olivetti, steel filing cabinets
- 20 Curtain slightly awry,
floral, wood-block
- 21 Blackout roller blind
- 22 Epidiascope and/or Bug?
- 23 Buddha head and/or Bug?
Tan sandstone, resin repro.
Gupta or Gandhara
- 24 Blue-black Islamic calligraphic tiles in angular Kufic
- 25 Timetable, calligraphy lesson:
How to do the definite article -- 'the' with a tailed 'e'
- 26 Chalk dust
- 27 Jet linoleum, gloss
- 28 Rukmini Devi, dancer:
*There is a much greater art
Than my dancing and somebody
That sculptrues. That is the
Art of the ONE artist who
Has created you and me.
How much more difficult
To create a work of art
That breathes and moves
That talks and walks than
Something that is still and lifeless.*



The World Turned Upside Down:
Art and Ethics in the Rise of
the “Stone Age South”

Sarat Maharaj

2017

**This text was
first published
in Malmö
Art Academy’s
Yearbook
2016–2017.
Reprinted
by permission
of the author.**

The thrust of today’s migrations seems largely “Northward”—even in the Antipodes, where they are clearly headed towards the opposite pole. The “South” has tended to signal underdevelopment and crisis. It has also flagged up notions of other possibilities, alternative perspectives, other designs for living. The exodus from the South to the North is at odds with the idea of the Global South as a privileged vantage point from which to critique the world system. We rather have anomalies and crossovers that affirm and straddle, unpick and unravel in one go the received N/S dividing lines. How to map this topsy-turvy global space, how to take its sound?

On the one hand, with today's migrations, the classic cardinal points and domains—East/West/North/South—are constantly fixed, even vehemently asserted. On the other, migratory drives surge and spill over such distinctions, blurring and undoing them—throwing up fresh contact and interaction. Do these emerging spaces mirror strands of the “primordial, pristine” space that our ancestors, Stone Age *Homo sapiens*, wandered into from “out of Africa,” to roam and rove what were the protocontinents? An “unnamed” space, prior to demarcations and orientations—or should we say, a pre-cardinal space? It seems to echo the rising post-cardinal spatial mentality and experience thrown up, against the odds, by today's migrations. With this streaming movement, do we have the glimmerings of a contemporary Palaeolithic non-cardinality?

The starting point for our project at Malmö Art Academy was a reconstruction of the Art History Room of the apartheid years. The AH Room was at the University of South Africa, University College in Durban for Blacks of Indian Origin. This is in the province of Natal with the great Drakensberg mountain range—uKhahlamba—which includes one of the world's most extensive sites of prehistoric rock art and cave paintings. The reconstruction or recreation in Malmö, Sweden, could have been in any mode—art installation, film, diagrammatic or performative statement, walks, discursive picnics, critical rambles, etc.

The Art History Room in Durban put on show an “evolutionary ladder” of artefacts, artworks, and cultures from across the world. Its effect, if not explicit objective, was to underline a Eurocentric vision of things—a view not uncommon in art studies of the time. Some took it to imply that the spectrum of world cultures and art forms existed in separate, segregated compartments, almost in parallel universes. To their eyes, the display embodied apartness—sometimes touted during the apartheid years as a “multicultural rainbow” (where, needless to say, some cultures were more equal than others).

But did the display also open up—perhaps quite unwittingly—counterviews, alternative readings? A glance across the original room inescapably brought into play notions of mix, exchange, and swap—the sense of brisk translation between diverse artistic and cultural idioms,

styles, and modes of thinking. What light could this throw on today's migratory swirl of peoples and cultural elements—on prickly issues of multiculturalism, its limits and shortcomings; on questions of living with diversity, difference, and multiplicity; on much-thumbed notions of hospitality and tolerance; on ceaseless everyday cultural translation and cosmopolitanising forces—all in a setting of apparent *racisme sans race*?

Our explorations in Malmö, centred around the reconstruction of the AH Room, which we called the Anti-Apartheid Room, linked up studies of the Swedish anti-apartheid archives, ranging over issues of South African and Swedish women; minorities and their overlooked place in representations of the historical struggles to end apartheid; North and South prehistoric, parietal art; and contemporary ancestral and aboriginal presences.

The AH Room had evoked the idea of a world art system: in some ways, it tended to mirror André Malraux's cosmopolitan views of art and culture in a "museum without walls." Today, does the development of the global museum—hand in glove with contemporary creative industries—see the makings of flat-pack, "globalised" art practices across our art education institutions, galleries, and museums?

To mull alongside: The AH Room had come into being with apartheid's segregating, ethnicising logic. At the time, opposition to this development was summed up in the slogan "Knowledge Is Colour Blind." What to make of such a claim in the face of today's search for a "decolonialisation of knowledge"—for "tonal modes of knowing"—not least in the thick of an all-encompassing knowledge society with its drive towards a pansophic world? What mileage for art practice, creativity, and art research, not simply as hard-nosed "knowledge production" but also perhaps as its opposite, as modes of "knowledgeable ignorance," as *Ignorantitis sapiens*?

Jürgen Bock

September
2020

Dear Gertrud,

I recently found a folded A4 brochure in my archive. Unfolding it, I recognised it as the contact list of Malmö Art Academy from 2004. The Dean—you—teachers, staff members, and departments are listed, as well as all students. Crosses, I believe made by myself, indicate the students who participated in my first course in Malmö, back in 2004/05.

It was my longest-ever course at Malmö Art Academy. Titled “Art Goes Public,” it was the result of an invitation you extended to me to develop a public art exhibition for the campus of Linköping University together with the group. Extra funding was in place, and having travelled with the group five times from Malmö to Linköping, I remember well a subtle, consistent, but at the same time productive tension between us as a group and the Linköping University administration, which due to the usual structural reasons had to defend its normative structures with rules we had to comply with when dealing as artists with a vast educational infrastructure—some participants experienced the campus as a “school as factory.” My course started in the autumn, and the show was developed over winter and spring—I remember the heavy snowfall during one of our trips—before taking place between May 26 and June 18, 2005. We were repeatedly told not to climb the roofs of any of the campus’s flat buildings, which finally gave us the title of the show (*Don’t Climb the Roof*). The then students Viktor Rosdahl and Jens Henricson claimed that by “conquering” the rooftops, they felt that they could overcome the intimidating aspects of the architecture they encountered, rising above it. At the time, I imagined climbing the roof of Ludwig Mies van der Rohe’s Barcelona Pavilion, which I don’t remember finding at all intimidating, thinking that it was Le Corbusier himself who invited the inhabitants of his architecture to enjoy their buildings’ rooftops.

Having spent a substantial amount of time discussing the project with the various participants from Norway, Denmark, Sweden, and the US, I learned a lot about Scandinavian history, politics, conflicts, cultures, and, for someone coming from southern Europe, rather subtly unfolding sensibilities.

One work sticks out in my mind to this day, by an artist who is mentioned in the handout (which lists all interventions made on the campus), but whose name I prefer not to reveal because of her anonymous intervention in another part of the city. Two signposts—one on the campus and another, identical one in front of the main station—were appropriated by adding two signs to each. But the two works unfolded rather differently. Firstly, on the campus, this happened with the permission of the university administration and the knowledge that somehow some art would appear, including the release of the artist's name and a short text on the intervention. The signpost in front of the train station, by contrast, unfolded anonymously: no author could be identified, with the artist renouncing the usual system of recognised authorship. The artworks were produced by the same company that had produced the original signposts in the first place, meaning the work was disguised by an appropriated design, like a chameleon taking on the colour of its surroundings. In its anonymity, which might have made some wonder if what they were seeing was art or not, it reminded me of the German writer Robert Gernhardt, who each day inserted a five-cent coin into the letterbox of one of his neighbours, as a reward for giving him something to think about. In Linköping, the signs indicated non-existent geographical locations in an almost caricatural way that referenced nationalism and its inherent distrust of the other.

In my framing of the exhibition, I claimed that most of the works in Linköping rejected the eternal claims usually made by public art projects. I referenced the art critic Craig Owens, who has written that such artworks' "impermanence provided the measure of their circumstantiality."¹ We never removed the signs, however. While writing this letter, I went on Google Street View to look at the front of the main station, with the Järnvägscafé on the side; it was from here that the artist and I, having brought a ladder for installing the signs, first observed the scene. The signpost still remains where it was, but the online image is too blurred to see if the added signs are still part of it.

João Penalva and Jimmie Durham mentioned Malmö first—the Academy and the city itself both small and clearly arranged, the name of the place a pleasure to pronounce, with its two M's, much softer than “Maumaus.”

A town in the south of a country that I only knew through a visit to its capital, in the north; participation in a conference and a visit to the studio of Matts Leiderstam, where I also encountered Cecilia Edefalk. A town in the south of Sweden, where in 1995 you founded a public art academy that proclaimed a hearty and energetic farewell to the entrenched pedagogies of the classical master-student relationship. The term “pedagogy—*Pädagogik* in German—is explained in a 1914 German dictionary of the Greek language as being derived from ancient Greek, its original meaning referring to “the tutoring of a boy in the field of arts and crafts.”

I had developed a classic photography school into a study programme—Maumaus Independent Study Programme, based in Lisbon—and João and Jimmie encouraged me to contact the Dean of Malmö Art Academy, who I had never met, to see if a collaboration between our two institutions might make sense. My memory may trick me here, however: psychological amnesia is common among humans, independent of age—we call it cryptomnesia in the field of the arts. But trying harder to remember, it becomes clear that the driving force was in fact my collaborator Mário Valente, who had also worked closely with João Penalva. Both spent several weekends in Maumaus’s lab and studio, processing negatives and enlarging photographs for one if not several of João’s projects, and after every session came the same question: Have you contacted Malmö?

I remember my annoyance at having to answer again and again: Not yet! And I remember too my concerns regarding how best to reach out to you, since it felt awkward to just contact an institution in Sweden out of the blue. Finally, before Mário stressed me out about it again, I chose a banal if not inelegant solution: a package with some modest publications was organised and sent along with a letter. I recall the feeling that this was not the right way of doing things—it felt more like I was doing it just for the sake of getting it done and relieving me of the friendly pressure of my dear colleague. I later learned that the books did arrive, but that the letter had gone missing—I probably *unconsciously but on purpose* forgot to add it. In the course of my current research for my PhD, I found the letter in the Maumaus archive—on a hard disk written using the now defunct software ClarisWorks, meaning it can no longer be opened.

In early 2004, an invitation arrived: take the underground to Oranienburger Strasse station and meet at Linienstrasse 135. It was the birthday party of a Portuguese curator, held on February 14 at the Sharon Stone Bar in Berlin. Isabel Carlos, who was also celebrating her nomination as the next curator of the Biennale of Sydney, had invited an international art crowd, and while I was standing at the counter ordering a drink, someone tapped me on my shoulder to introduce us. Warm-hearted, with a big smile and much laughter, you told me about the missing letter, and of not knowing what to do with this anonymous package of publications sent over from Portugal. Very pragmatically, a visit to Lisbon was arranged on the spot. Details were supposed to be arranged via email, and an initial understanding of your notion of what an art academy is became clear when you requested studio visits with current and former participants of the Maumaus school, so that you could report back on these encounters to your students, in case an exchange programme was agreed upon.

And things moved fast! You announced not only that your arrival in Lisbon would come just five weeks after our encounter in Berlin, but also that your International Exchange Coordinator, Jenny Svensson, would join you. I understood that this would be a serious visit and realised that your research trip would overlap with those of the artist Allan Sekula and art historian Sally Stein. Allan came to Lisbon in order to prepare his exhibition at a commercial gallery, which, by supporting a book of his (to be published by Maumaus), was able to convince him to show at their venue. I curated as usual, and as usual when it comes to the selling of art, with all the non-glamorous aspects of the art market, I decided not to translate everything the gallerist said to Allan. Allan's wife, Sally, also came along for her teaching sessions at Maumaus. Of the four of them, I knew Allan best, and you from our very brief encounter in Berlin, so it was a case of taking the bull by the horns: nothing besides the requested studio visits was to be specially organised, no protocol, "just participate in what is taking place." Sally's talk "The President's Two Bodies: Stagings and Restagings of Franklin D. Roosevelt and the New Deal Body Politic" was one of the highlights, allowing you to also assist in Sally's dramatic prelude of refusing to give her talk if Allan didn't finish drawing up a long-overdue bill of expenses for the Museu d'Art Contemporani de Barcelona. Our encounter as a group had all the ingredients of a blind date: it could be either a failure or a success, and the question of how to judge which of these it actually was is a story of its own. Both you and Jenny joined the Maumaus participants for Sally's seminar

in the legendary “wallpaper room” of the old Maumaus, which was only recently substituted by a “copper room” in the school’s new domicile.

At the end, all five of us squeezed into a rental car to head to a hotel situated an hour north of Lisbon. Arriving at the guesthouse O Facho, which is located directly on the beach in Foz do Arelho, Allan instantly disappeared for a swim in the stormy sea, to the great concern of the hotel owner. Seeing as we were staying one night only, we were lucky to have the best breakfast table reserved for us, with its astonishing view of the Atlantic. We had intense discussions about and around art and politics and all their inherent contradictions, also considering the particularities that are to be taken into account when it comes to teaching art in given, reshaped, and invented frameworks. On the way back to Lisbon, we made a quick stop in Peniche, a port city of fishermen, where you turned strangely quiet as we ate some shrimp in a tiny traditional restaurant. Jenny, rather discreetly, enlightened me that this was due to your enjoyment of the food.

Your programme in Lisbon turned out, without my intention, to be rather intense. The excitement of encounters, the exchange of knowledge and experiences, and the inspiring discussions took all our time and energy. It was only on the last morning before you and Jenny were due to head to the airport that we directors both took an espresso at the counter of the Pastelaria that was close to the old Maumaus. Time was scarce and you got straight to the point: “And now? How do we continue? Well, you have to come to Malmö.”



***Climb the Roof*, Jens Henricson and Viktor Rosdahl, May, 26, 2005. Image courtesy of M. Wickström**

1 Craig Owens, “The Allegorical Impulse: Towards a Theory of Postmodernism,” in *Art in Theory, 1900–1990*, ed. Charles Harrison and Paul Wood (Oxford: Blackwell, 1996), 1054.

Olav Christopher Jenssen 14
Progressive Symbolic Dynamic
Drawing
for Gertrud Sandqvist
Stage 01

2020



Progressive Symbolic Dynamic Drawing
for Gertrud Sandqvist

Stage 02



Progressive Symbolic Dynamic Drawing
for Gertrud Sandqvist

Stage 03



Progressive Symbolic Dynamic Drawing
for Gertrud Sandqvist

Stage 04

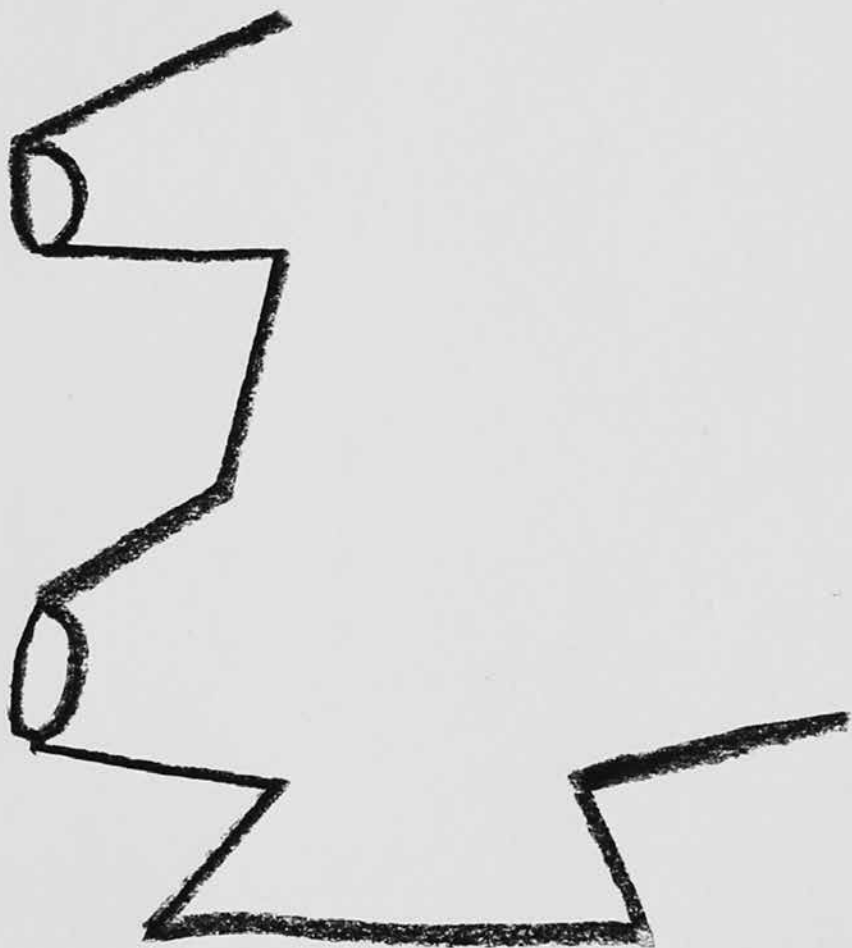

Progressive Symbolic Dynamic Drawing
for Gertrud Sandqvist

Stage 05

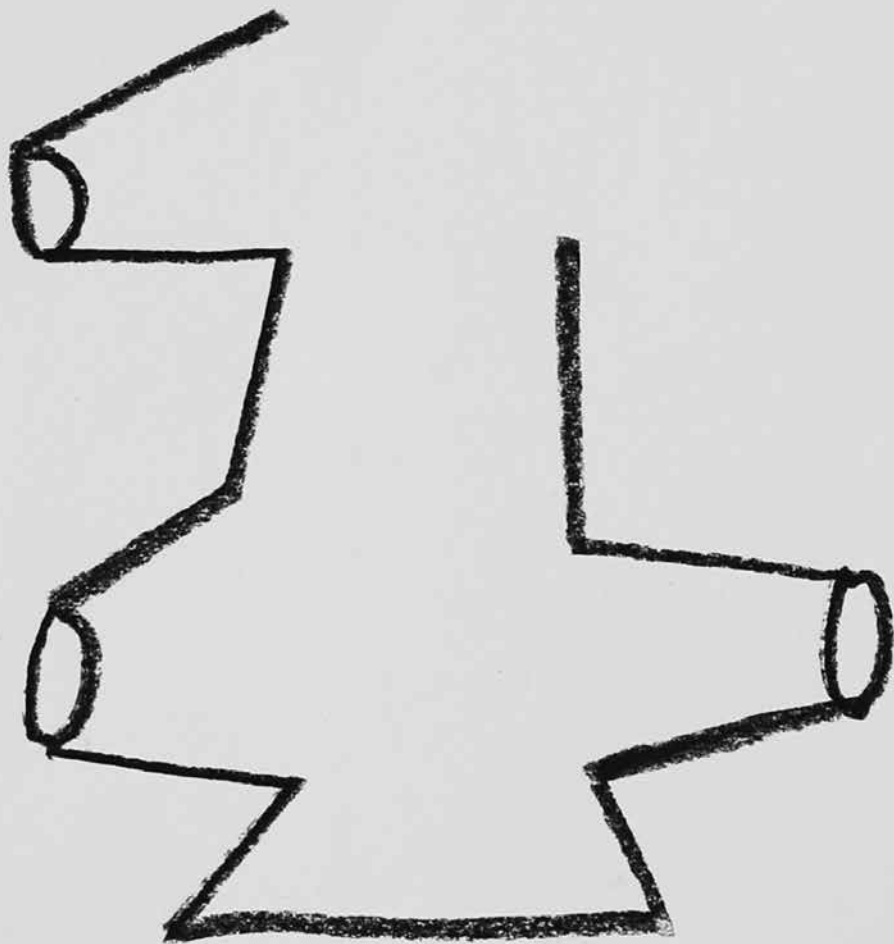

Progressive Symbolic Dynamic Drawing
for Gertrud Sandqvist

Stage 06

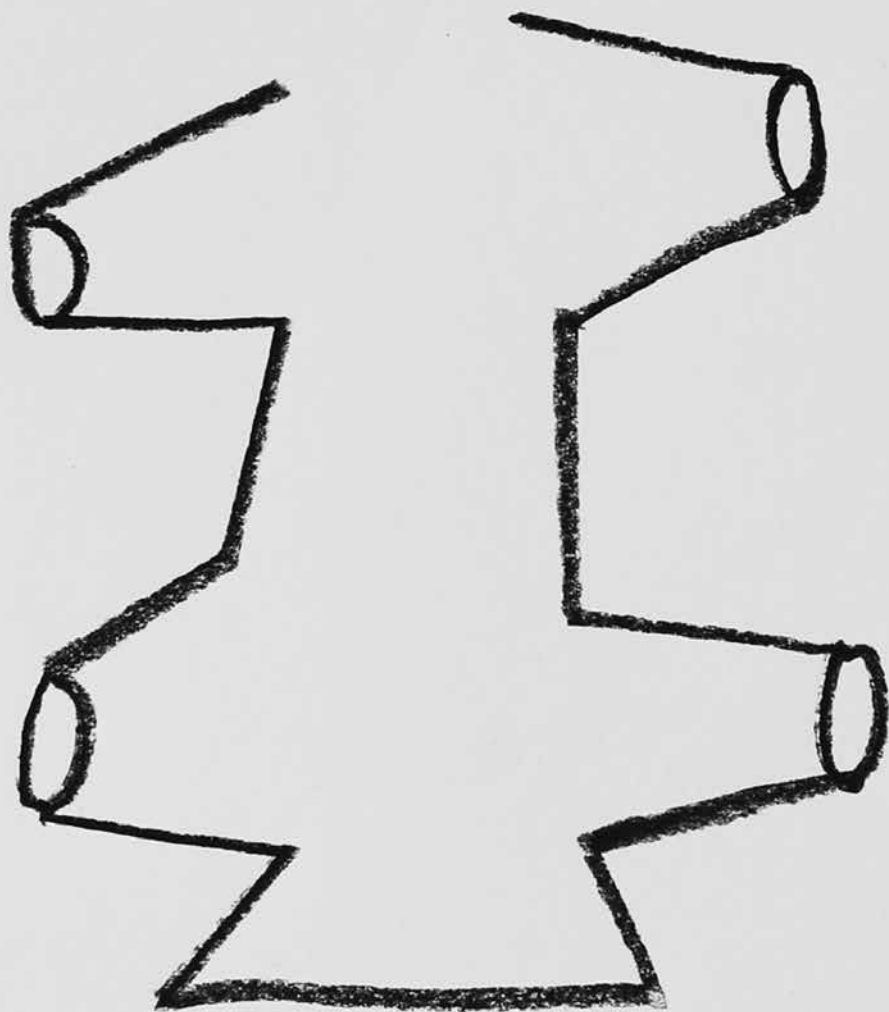

Progressive Symbolic Dynamic Drawing

for Gertrud Sandqvist

Stage 07

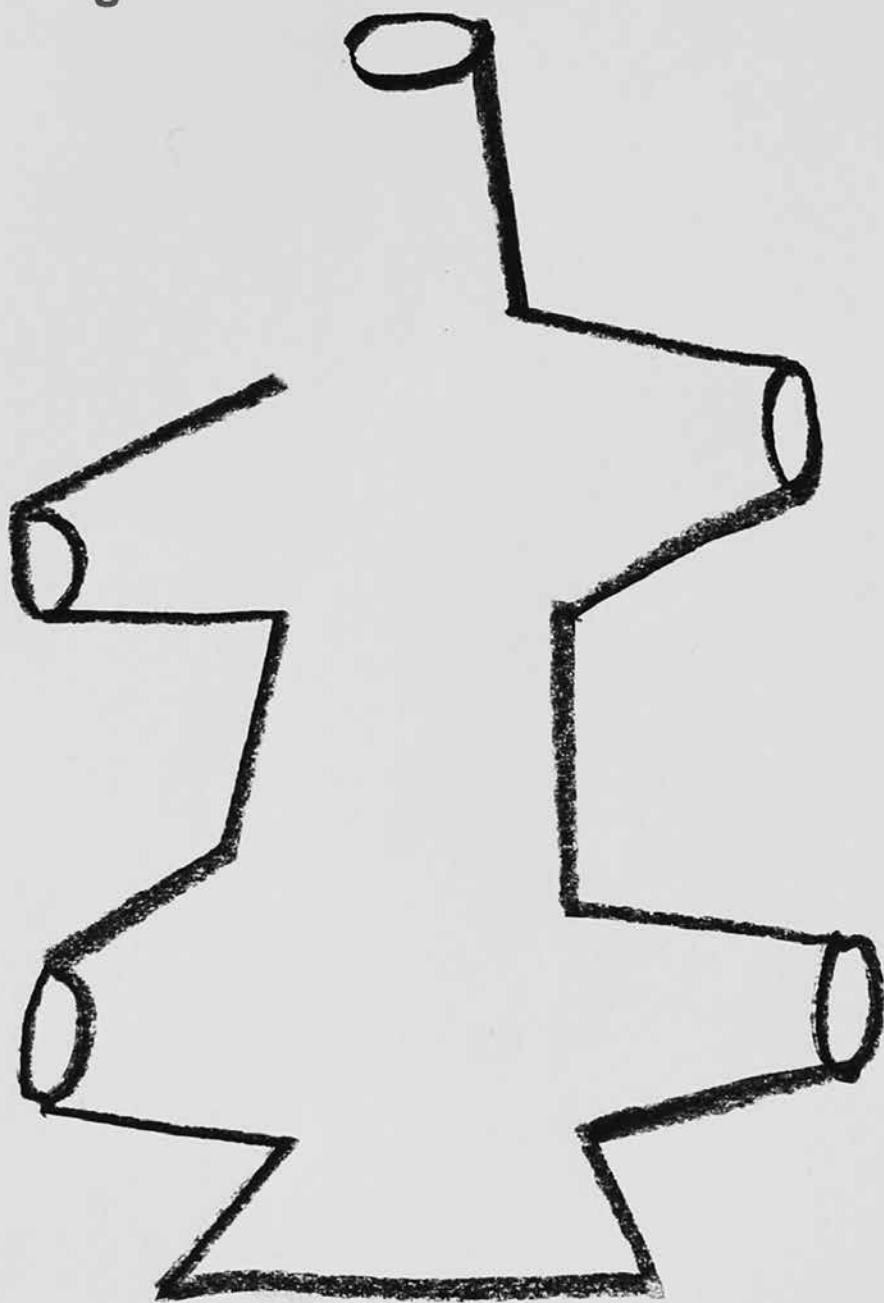

Progressive Symbolic Dynamic Drawing
for Gertrud Sandqvist

Stage 08

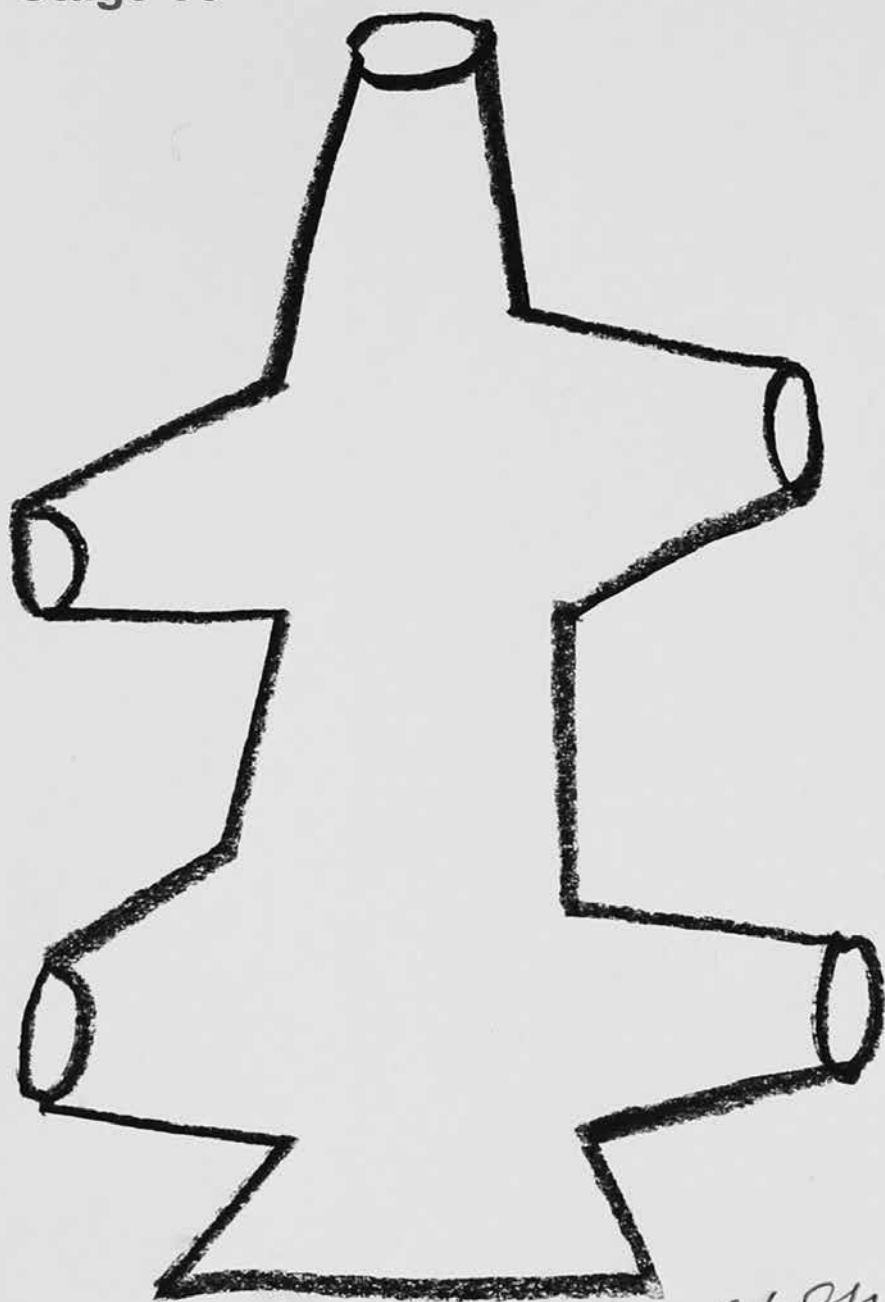

Gertrud Sandqvist

Image pp. 222–223:

Lars Nilsson, *Game is over*, 2000. Installation view, Magasin 3, Stockholm Konsthall. Image courtesy of Jan Engsmark

Stockholm,
September
2020

During the spring of 1995, I received a phone call in my hotel room in London. I was told I had been appointed one of the professorships at what was to become Malmö Art Academy. I accepted, on the condition that I wouldn't have to remain in the position for more than three years. I ended up staying for eleven.

The years I spent at the Academy are some of the best times I've had as an artist. Getting to share your knowledge and to follow the trajectories of some of our finest contemporary artists in the roles of teacher, colleague, and, often, friend.

We started out with a blank slate: an empty building and an ambition to reform art education—an ambition we went on to fulfil. To play an active role in this kind of upheaval, in which words are to give way to action, one must remain humble enough to admit that some things didn't work in a real-world application. But by the third year, it was mostly in place: a cutting-edge art programme that offered breadth and depth, passionate discussions, and diverse opinions. I am genuinely proud of what we and the students accomplished together. The dynamics and energy that we generated also provided space and momentum for my own artistic practice to flourish—which explains why I stayed on for all those eleven years.





Gertrud Sandqvist has a solid background as a curator and critic, something that has benefited the school and its students during all her years as Rector and leader of the Malmö Art Academy. With her insight, networks, and understanding of how the art world works, she has promoted the Academy's activities and helped students enter the professional field. She has opened up the world to them, and thus also opened up their own worlds.

Exhibitions allow artists to meet audiences and to understand whether their artworks are understood by others. Exhibition-making skills, including the behind-the-scenes logistics, have long been part of the art Academy's teaching, not least in connection with the students' graduation exhibitions at the school's own galleries in Malmö as well as the annual Open Studios exhibition at the Academy itself. Malmö Art Academy's recent graduates have frequently exhibited in public and private galleries and museums in the region and internationally. Lunds konsthall, of which I am director, has been a recurrent collaborative partner over the last fifteen years, but so have other institutions in the region since the Academy's founding in 1995: Rooseum Centre for Contemporary Art, Moderna Museet Malmö, Malmö Konsthall, Malmö Art Museum, and Skissernas Museum.

Many of the following collaborations between the Malmö Art Academy and Lunds konsthall have taken place with Gertrud as curator. These exhibitions have helped our visitors grasp how the Academy works and how important it is to the art world, both in the region and far beyond.

The Doctoral Programme in Fine Arts

The Malmö Art Academy was the first art academy in Sweden to launch a PhD in Fine Arts. The programme incorporates two fundamental notions: that contemporary visual art relates closely to other fields of knowledge, and that practising artists have increasingly become involved in investigations transcending a traditional understanding of “artistic practice.” Doctoral dissertations consist of interdependent visual and textual components.

The school’s first three doctoral candidates to defend their dissertations — Sopawan Boonnimitra, Matts Leiderstam, and Miya Yoshida — exhibited these “visual components” at Lunds konsthall in September 2006, with the exhibition *Three PhD Projects from the Malmö Art Academy*.¹

Sopawan Boonnimitra, an artist from Thailand, presented *Lak-ka-pid-lak-ka-perd*. The politics of space is central to discussions about the rights and agency of minorities, which often focus on overcoming confrontational dichotomies such as centre/margin, global/local, self/other, hetero/homo. The notion of “queer space” was coined as a strategic tool by sexual minorities in the West in the 1990s. A better understanding of non-Western sexual cultures may help us overcome notions such as the “boundary” and the “dichotomy.” The Thai term *lak-ka-pid-lak-ka-perd* literally means “sometimes closed, sometimes open” and occasionally refers to homosexuals. Boonnimitra’s research project aimed to explore the Thai urban landscape in relation to the transformation of queer culture in and through the arts.

Matts Leiderstam, an artist from Sweden, presented *See and Seen*. In eighteenth-century England, the “ideal” pastoral landscapes of Nicolas Poussin and Claude Lorrain inspired landscaped parks and theories of the picturesque. These constructions spread within the British Empire and still partly determine the Western notion of “landscape.” Since the early 1990s, Leiderstam has subjected the pastoral landscape to a parallel homosexual gaze, comparing it to the cruising park. *See and Seen* focused on a painting by Lorrain and a real view of an existing historical landscape.

Leiderstam entered into different roles — the copyist, the tourist, the art historian — and used them as “routines for seeing.”

Miya Yoshida, an artist from Japan, presented *The Invisible Landscapes*. Yoshida’s research is aimed at the visible, the invisible, and the invisible within the visible. Telecommunications have long been regarded as mysterious or “uncanny.” *The Invisible Landscapes* investigated the complex spaces created by mobile telephony: new realities generated by small individual acts but connected to the crisis-ridden mass imagery of politics, the media, and advertising. The project assessed the impact of the mobile phone as a connecting point for contemporary modes of thinking, not least in visual art. A related issue is how new technologies increasingly involve art.

Since its launch in 2001, doctoral programme of the Malmö Art Academy has continued to function at the highest international level.

International Collaboration

The exhibition *ESCAPE* in January–February 2011 was a collaborative project that involved more than twenty students from four art academies: Malmö Art Academy, the Braunschweig University of Art, Maumaus Independent Study Programme in Lisbon, and International Academy of Art Palestine in Ramallah.² Together they worked on the deliberately expansive theme of “escape”.

The mass media constantly feed us reports on disasters affecting humankind. We are flooded with images showing people trying to escape natural disasters, poverty, war, and oppression. Such images provoke both anxiety and fascination. How are they constructed to achieve this effect? Many people also flee into themselves. Such inner exile is sometimes to do with protecting a private zone but may also be close to madness. How does the drug culture and the daydreaming that the media encourages relate to our longing to escape reality? The notion of escape contains both violence and desire. How can this be expressed in art?

The international and the regional are always intimately interconnected in contemporary art. This is certainly true of art academies, where international

exchanges and collaborations are now an established part of the curriculum. Teachers and students from different countries come together to develop an integrated vision of art as an international arena that is sensitive towards the cultural identity of specific regions. In hosting *ESCAPE*, Lunds konsthall wanted to underline the importance of this kind of internationalism, for now and for the future.

Research by Gertrud Sandqvist

The group exhibition *Channelled* in February–June 2013, which was curated by Gertrud Sandqvist, was based on the thinking of visionary Swedish artist Hilma af Klint (1862–1944).³ The exhibition’s title refers to the significant concept of “inspiration,” which originally meant “breathing in” – something that is breathing through you, or that you are precisely “channelled” by this something. Inspiration and its crucial importance to practitioners of both science and art has been intensively discussed at various times since the emergence of romanticism in the eighteenth century.

In af Klint’s lifetime, this discussion was particularly active within theosophy and anthroposophy, two schools of thought that attempted a synthesis of the known and the unknown, the conscious and the unconscious. Today af Klint is mostly known for her esoteric painting, which can be described as systemic visualisations of complex philosophical and spiritual notions. Her paintings were always preceded by notes, of which those from 1905–16 have been characterised as “inspired from outside” (i.e., dictated by spirits, the High Ones) and the later ones as coming from her own spiritualist research.

Gertrud had spent several years studying around 150 occult diaries in which af Klint documented her method and process in great detail. They also reveal her relations to the authorities of the time – not least the founder of anthroposophy, Rudolf Steiner – and her struggle to maintain intellectual independence. The *Channelled* exhibition included a hitherto unknown series of af Klint’s drawings from 1917, a kind of set of spiritual notes or sketches.

Continuity of Knowledge

On the occasion of Lund University's 350th jubilee, the exhibition *Wither the Winds* at Lunds konsthall, which took place May–September 2017, presented a selection of the many accomplished artists who have been affiliated with Malmö Art Academy throughout the years: Professors, Lecturers, External Tutors, and doctoral candidates.⁴

The exhibition described how the Academy is part of Lund University and was founded in 1995 to continue the activities of the Forum schools of painting and printmaking in Malmö. Furthermore, it showed how, in a relatively short time, Malmö Art Academy has built a solid international reputation for itself, and how it today offers an advanced and varied array of courses and programmes, all adapted to the students' individual needs.

The Academy receives a large number of applications every year, not just from all parts of Sweden but also from the neighbouring Nordic countries, Europe, and the rest of the world. It is a great advantage for the region that some of the sharpest students and teachers of contemporary art gather here. The continuation of the sort of research, production of knowledge, and international exchange undertaken at Malmö Art Academy is of great benefit both to our region and to society at large.

1 Professor Sarat Maharaj is Principal Supervisor of the doctoral programme at Malmö Art Academy, run by Gertrud Sandqvist. The curator of the exhibition was Anders Kreuger.

2 Participating artists: Majd Abdel Hamid, Joanna Bini Eda, Caire de Santa Coloma, Miro Dorow, Karen Gimle, Til Heinicke, Leonie Hesse, Khaled Jarrar, Nina Jensen, Ingrid Koslung, Anne-Kathrin Loth, Henning Lundkvist, Tiago Mestre, Nikolaj Nekh, Olof Nimar, Lydia Paasche, Sofia Berti Rojas, Omaya Salman, Julian Stalbohm, Sarah Steiner, Maiken Stene, Lars-Andreas Tovey Kristiansen, André Trindade, Thale Vangen, Joen P. Vedel, Martin Weiser, Constanze Wicke. Curators: Jürgen Bock, Olav Christopher Jenssen, Gertrud Sandqvist, Viola Vahrson.

3 Participating artists: Carolus Enckell, Olav Christopher Jenssen, Hilma af Klint, Joachim Koester, Christine Ödlund, Silja Rantanen, Nina Roos, Emily Wardill. Curator: Gertrud Sandqvist.

4 Participating artists: Rosa Barba, Charif Benhelima, Matthew Buckingham, Jimmie Durham, Maj Hasager, Olav Christopher Jenssen, Mary Kelly, Joachim Koester, Matts Leiderstam, Sharon Lockhart, Lars Nilsson, João Penalva, Nina Roos, Jim Shaw, Sophie Tottie, Emily Wardill, Haegue Yang. Curators: Åsa Nacking, Emil Nilsson, Gertrud Sandqvist.

1

3/1/77



2 (a)

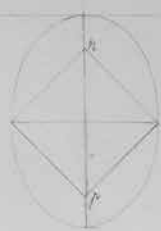
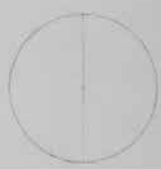

Images on the left and pp. 232–233:
Hilma af Klint, From unfinished series of drawings. February 3–March 29, 1917.
Courtesy of the Hilma af Klint Foundation, Järna. Image courtesy of Terje Östling

no. 12

2/2/177

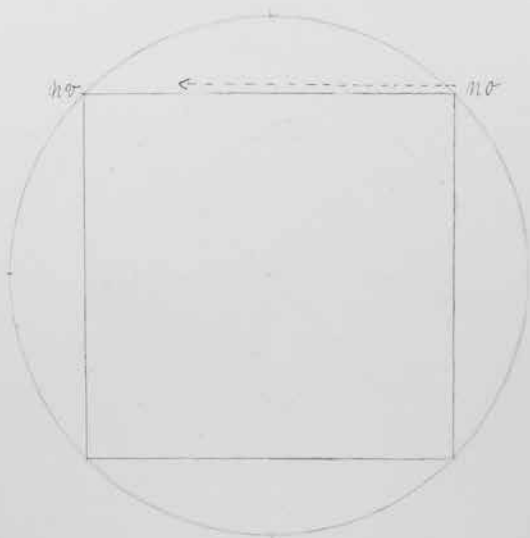

no. 13

2/4/177

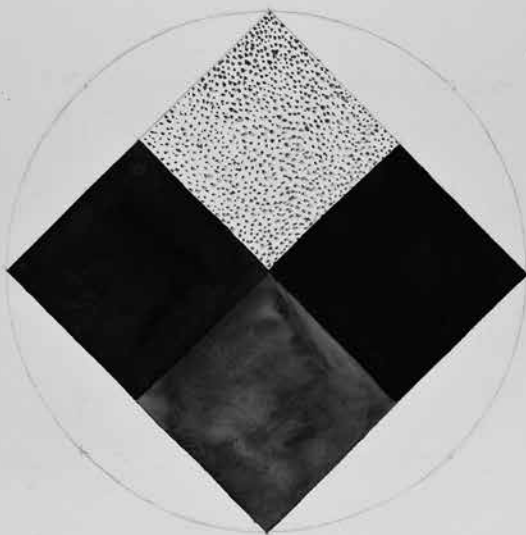

14-14

2 1/2 1918



14-15

2 1/2 1918

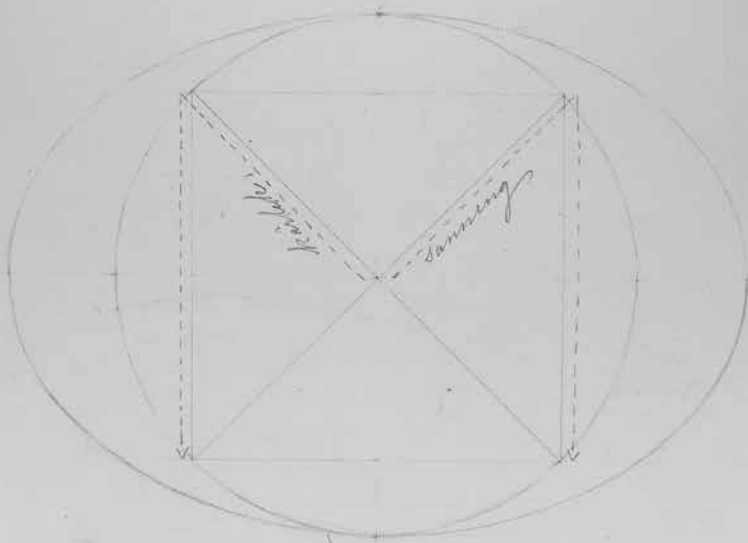

Over the last forty years, the conceptual approach has been ever-present in contemporary art, and its normativity has been stabilised at the expense of visual observation. These four decades coincide with my own time working as an artist. When I finished art school in 1980, it was already common for young artists to claim that their works weren't composed at all. Regardless of these assurances, most works still revealed the presence of visual ambitions.

After two historical waves of purely conceptual art movements, this third phase sees the conceptual strain diversify its basic approach into several less strictly conceptual artistic disciplines. In the last few decades, it has almost become the rule that an artwork, in order to be of substance, must incorporate a metalevel, a cognitive point of view from which the artist can give

a theoretical interpretation of their own work and frame its subject within a certain context.

In his study *Sublime Art: Towards an Aesthetic of the Future* (2017), philosopher Stephen Zepke analyses the evolution of conceptualisation in art in reference to the theories of artist Joseph Kosuth. Kosuth claimed that the form of the artwork was "secondary information," while the work's concept, its "reason to be," was the primary information. Kosuth defined art as a conceptual activity, the purpose of which was to liberate art from the conservative, repressive conditions it was subject to. As Zepke explains:

As a result, today art requires a minimum of "conceptual" reflection (i.e. rational "thought") on its own concept to be considered "contemporary."

A good example of this minimum condition is a painting that foregrounds its status as a “representation,” in this way organizing or at the very least premising its aesthetic and material aspects around its conceptual core or condition.¹

The two tendencies mentioned above might be broadly defined as the (modernist) approach to visuality as independent of its knowledge-based meaning, and the (postmodernist) approach of acknowledging the contextual interactions of all things, respectively. The latter leads to the conclusion that any piece of knowledge is potentially relevant and could be projected onto whatever it is we’re currently regarding or depicting. The speech of “semiotic art” or “psychoanalytic art” is thus misleading, as semiotic or psychoanalytic interpretation theory can, in principle, be applied to any work of art.

It’s certainly foolhardy to attempt a brief, concise definition of a pair of opposites as tightly linked as the one I’ve sketched above. However, this abstract dichotomy has held a deeply personal meaning for me, and still does. It’s a common thread throughout my personal history in art. The front lines are always being redrawn, and there is always a risk that one might end up on one’s former

enemies’ side; but despite this, I remain captivated by the intricate interactions of the visual and the conceptual. They have both existed, side by side, as different levels of interpretation, but neither has ever managed to single-handedly offer sufficiently broad definitions of art. Knowledge cannot do full justice to the essence of art any better than “innocent” visuality can.

During my own years as an artist, this competition between knowledge and visuality in art has performed a dialectical somersault. As a young artist, I was militant about staging assaults on the modern concept of visuality. Now that the pendulum has swung back to the other extreme, artists seem to be taking less of an interest in compositional considerations. The increasingly elevated station that conceptuality was afforded within the art world reawakened me to the importance of visuality.

From the proud creative delight I took in adjusting my thinking and knowledge to art in the early 1980s, I’ve come to revise my attitude in recent years, and I’ve ended up committed to a defence of the sensibility to compositional concerns that I find to be neglected today. The consistent aspect of the “revisionist” development of my thinking rests in my conviction that the ongoing discussion of art between my colleagues and art theorists is an important source of knowledge. My vision always relates to the general discourse within the

field of art. That's not to say that I blindly conform to the majority, but my opinions are still reactions to the "received" opinions of the majority. I don't subscribe to the thesis that a work of art could exist without an appearance. The appearance is a symptom of the structure of the work, which is in turn a reference to the artist's concept.

Conceptual art has its own compositional schemes, which are typical of its age. It's essential for an artist to be able to recognise these, as well as to analyse their relationship to the ideas that one desires to communicate to the viewer. For example, distance to the subject is a core feature of contemporary art. In what way does the external format of the artwork represent this? How can this distance be expressed in a painting, a medium that is essentially affirmative in nature?

I will offer two examples of compositional schemes that reflect the conceptual content of contemporary art: installation as an inter-medial artistic format, and blurred contours in contemporary painting.

On Installation

To present something is to make an emancipatory gesture. Whoever places buildings in public space in a city plan is exerting power over the city's inhabitants. A corresponding position of power, this time with a hint of the didactic, belongs to the person who hangs artworks for an exhibition. Traditionally, this

task has been reserved for others than the artist, to maintain a degree of objective expertise.

In the 1960s, contemporary artists began to take action to reclaim the authority to decide about the hanging for themselves. These reactions of artists arose at the same time as the first theories of institutional critique. This emancipation resulted in exhibitions resembling unified works, such as Claes Oldenburg's exhibition *The Store* (1962) in New York. Among the pioneering works of installation art were the experimental hangings of found objects in trees in the parks of Rome that Robert Rauschenberg carried out in the early 1950s.

It has since become customary for the hanging of an exhibition to be guided by installation-like principles. Regardless of who is responsible for it, the layout is based on the idea that the architectural surroundings will somehow actively interact with the works of art. Negotiations over the boundaries between the domains of the artists and the institutions are still ongoing. A common, but often unstated, argument offered by artists is that the relationship between the works and the walls is a part of the art. This problematic argument has served us artists well in our struggle to take control over any aspects of the situation that we realise might impact the content of the art.

However, artists don't only, or even primarily, make installations for political purposes. On the other hand, installations, as well as certain sociologically oriented art genres, are often utilised by museums because of their potential for popular appeal. Installations almost fit *too well* into the general discourse on how art relates to the outside world.

My own interpretation is that there are two main reasons why installations are so popular among artists today. First, the gesture of "presenting" is an alluring method, as it allows you to create something without actually fabricating a new object. But second, and more importantly, installation is used as a sculptural format by all media today, because it is such an excellent metaphor for how contextualisation works. Placing objects in a contrasting surrounding, or in a way that makes a surprising comparison, is an act that has the trappings of a scientific experiment while also remaining true to the core notion of creation: combining things to produce unexpected results.

In the play of children back in the predigital age, the method of installation was often used inventively, in that dolls were animated like puppets whose movements were controlled by the child, who also uttered the doll's lines. Digital gaming represents a continuation of this performative structure—an update, if you will. The first time

I encountered installation art, at Kunsthalle Helsinki in 1969, the games I had played as a child were still fresh in my memory. The work in question was Harro Koskinen's installation *Svinfamiljen* (Swine family). The swine were painted with a dense, yellow pigment, and their habitus had been humanised, although they remained lifeless and smooth. Along with their armchairs, they were arranged into a convincing simulation of a petit-bourgeois living room complete with a lounge suite. The whole scene resembled an enlarged doll's house or theatre play.

However, *Svinfamiljen* didn't conform to the conventional notion of sculpture, because the figures were able to invade the space and establish an alternate reality inside the art gallery. The air and the floor around the figures appeared to be within *their* territory, rather than as aspects of the gallery space's atmosphere.

Svinfamiljen thus distanced itself markedly from any classical sculpture incorporating several figures, such as the ancient Greek sculpture *Laocoön and His Sons* (27 AD) or all the famous monuments to groups of shipwreck victims or citizens of Calais, in which human limbs cast in bronze wrap around one another like strands of pastry in an enormous rosette cookie.

Koskinen's swine family were uncomfortably perched on their oversized plastic chairs, which had been made using the same method as them. The chairs didn't match

one another in a plastic sense, either. They took up too much of each other's space, which prevented all the organic mess that is so characteristic of the spatiality of a pigsty from accumulating. This manner of plastic dystopia lends itself particularly well to being presented as an installation. Objects and beings, insensitively rubbing against one another, without producing the slightest degree of harmony or triggering any response in each other. This is, after all, how our everyday spaces are laid out today.

In Helsinki in 1969, Koskinen's structural radicality passed by unnoticed. What ended up causing persecution by the exhibition jury was his painting of the coat of arms of Finland, in which he had replaced the lion with a swine.

On Diffuse Contours

These days, we tend to think of blurred contours as indicative of a faulty optical instrument. "The camera lens needs adjusting" seems to be what a blurred form communicates to us. However, in art, the history of blurred contours goes much further back in time than the manipulation of photographs. In classic landscape painting, the degree of blurriness is aligned with the aerial perspective. The eighteenth-century painter J.M.W. Turner came up with the idea of painting landscapes in a light that dissolves all solid forms, and this vision of his contributed to the later

development of modern and, later still, abstract painting.

In more recent art history, blurred contours have served a didactic purpose in colour theory. Art students have been encouraged to blur the contours of their figures in order to maximise the colouristic effect. In this context, blurriness serves an indirect function: to achieve precision in colour use, the other dimensions of painting are temporarily relocated to the background.

More than any other metaphorical feature, a blurred image can be experienced on a universal level, as a symbol of a loss of faith in progress. The blurriness suggests that the relationships between ignorance and knowledge, on the one hand, and information and knowledge, on the other, have become even more fleeting than before.

Blurred contours are a trademark of the artist Gerhard Richter. In the early 1960s, he began to use this method in his paintings, which he based on everyday photographs of both a personal and a journalistic nature. He applied light brushstrokes using a large brush on a wet, photo-based painting to achieve a particular effect. This gesture is easily identified and remembered. Paradoxically, its role within the anonymous whole of the image can be interpreted as representative of the artist's own brushwork; but here the blurred contours are mainly used

to signify distance, to camouflage the subject, or to introduce a general sense of alienation. Later, Richter would adopt a similar method when working on his abstract paintings, although he was not attempting to conceal the subject in this case.

After the arrival of the digital era, we've seen an abundance of variations on Richter's gesture in contemporary art. In recent painting, this aesthetic has undergone an extensive renaissance and has begun to be used as a reference to the ephemeral nature of digital imagery. As a way of relating to this universal visual idiom of our times, painters have allowed the blurry to enter the medium of painting, although the traditional vocabulary of the field has always held the sharpness of forms to be an exalted virtue.

In Ulla-Lena Lundberg's novel *Allt man kan önska sig* (All you could ask for, 1995), she provides an excellent answer to the question of what a conceptual artwork looks like. The narrative relates an interview with a forty-two-year-old female artist from Åland. The reader isn't told if the subject is a fictional person, or if this is a case of actual social anthropology research, a field in which Lundberg has worked as an academic. The author doesn't pose the question as I've written it here, but rather lets the artist speak freely about her approach to her work, placing particular emphasis on a stressful life situation that ended up becoming a source of inspiration,

against all odds. She describes her conceptual series of paintings titled *Storkök* (Restaurant kitchen), which consists of subjects she encountered when she did temporary work on one of the cruise ships that offer passage between Sweden and Finland:

You may recall that my objects are a little blurred and indefinite in terms of their form; as though you saw them in the corner of your eye just as they were rushing past. They're meant to make you feel a sense of urgency. Everything revolves around the objects, and you never get to see a whole human being, only parts. A blurred foot next to a broken coffee cup, where the pieces have come to rest, making them seem particularly clear. An arm in a rubber glove, a rear end with a skirt behind the table full of dirty dishes... those kinds of things. Human beings serving functions, rather than being individuals.²

In this passage, we find that a contemporary artist's work is based not on visual observations but on analytical themes. Still lifes of a restaurant kitchen's piles of dishes would never have provided sufficient subject matter. She fuelled her thinking by taking into consideration the fact that her work in that kitchen was essentially involuntary, a task carried out to finance an artist's

practice. However, this friction between her calling and reality is inspiring to her: although working outside of her area of competence, she uses her expertise to inform her observations. The objects around her give shape to her discomfort. This occurs through blurred, fragmented forms. The narrative of the artist reveals that her subjects are tightly connected to the compositional means that she uses to express her vision.

- 1 Stephen Zepke, *Sublime Art: Towards an Aesthetic of the Future* (Edinburgh: Edinburgh University Press, 2017), 5)
- 2 Ulla-Lena Lundberg, *Allt man kan önska sig* (Helsinki: Gummerus, 1995), 267.

Lecture,
November 25, 1996

18

Ola Billgren

This is a modified version for print of a lecture Ola Billgren gave at Malmö Art Academy in 1996 and was part of the Art Academy's *Yearbook* of the following year. Reprinted by permission of Anita Billgren.

When an artist, of one kind or another, consents to make a public appearance and expound his or her views on language, in most cases it is probably with a feeling that the audience will not have too high expectations of his or her competence and reading in the philosophy of language. This was what I thought when I spontaneously accepted an invitation to come to the Malmö Art Academy and open a discussion on the subject. I imagined that I would enjoy a certain protection by the fact that, in a way, I had already, in my paintings and to a certain extent in my writings, installed myself in language, and that my speech would flow unaffectedly and freely. But soon I felt that a reflection on language that wishes to be clarifying—and

nothing else is the case—could hardly be based on such a privilege; in such cases, it runs the risk of becoming a mere defence. The fact that language in the sense of “my language” or “language for me” is a conquest, related to artistic practice, does not make my taking part in it any easier and safer when I consider it as a general phenomenon—which, besides, is something I was aware of from all the occasions when I have broken the silence that surrounds my work.

So I must confess that I'm attracted to the difficulty without taking the full consequences of it. I was puzzled when thinking about what kind of presentation I was expected to do. When it comes down to it, it is not about achieving

the expected but doing the necessary, and this is what is so very difficult in this case. Naturally, I tend to see the work of art and artistic practice as the ultimate form of investigation and communication. Accordingly, there is a sort of moral reason for me for keeping to it, since it is there I should invest my maximum knowledge. On the other hand, it is hardly any help to wrap it up in silence, to be alone with it, although there are many poets who prefer to see things that way. In fact, literature remains ambiguous on this point: it is not always possible to make a clear distinction between literary texts—narratives, poetry—and texts that deal with questions of writing.

In other words, by entering a dialogue on language I have put myself in a middle position, where the notion that describes my desire best—to realise myself in my own, more or less unique and exact language—requires my attention in itself. So I end up outside of it, but close to it. I am forced to exert myself, and instead of talking from the point of view of what I think I have achieved, I have to talk about the general characteristics of this achieving. We now run up against a question: Why so much work on an attempt to define a specific artistic language, and why does language become the object of exclusive, personal possession? The scope of the question is such that I have no hope of even coming close to answering it. But, with the help of a text that came to my rescue, I can at least hope to clarify something in relation to creativity in language. The text, which I will read in its entirety, was written by Novalis' in 1798, that is, at an early stage of romanticism, when the instrumentalist view of the poetic word came under ardent attack.

Novalis, "Monologue"

There is actually something silly about speaking and writing; true conversation is a mere play on words. We can only admire the ridiculous delusion of people who think that they speak for the sake of things. Precisely what is peculiar about language, that it only cares about itself, no one knows. That's why it is such a wonderful and productive mystery, the fact that when someone just speaks for the sake of speaking, he says the most marvellous, most original truths. But if he wants to talk about something in particular, facetious language makes him say the most ridiculous and confused things. Out of this comes also the hate that so many serious people feel for language. They notice its willfulness, but do not notice that the despicable babble is the infinitely serious side of language. If it were possible to make it clear to people that language is like mathematical formulas—These constitute a world for themselves—They only play with themselves, do not express anything but their own wonderful nature, and this is exactly why they are so expressive—and this is exactly why they reflect the strange play of relations among things. Only through their freedom are they part of nature and only in their free movements does the world-soul express itself and turn them into a delicate yardstick and ground plan of things. So it is with language too—he who is sensitive to its fingering, to its rhythm, to its musical spirit, he who perceives the delicate effects of its inner nature, and moves his tongue and hands to

it, will be a prophet; on the other hand, he who knows how to write truths like these, but who does not have enough ear or feeling for language, will be made fun of by language and mocked by people, like Cassandra was mocked by the Trojans. If I think that I have shown clearly the essence and task of poetry by this, I am still aware of the fact that no man can understand it and that I have said something foolish, because I wished to say it, and no poetry comes about in that way. What if I was compelled to speak any way? And if this linguistic urge to speak were a characteristic of the inspiration of language, of the functioning of language in me? and if my will only willed all that which it was compelled to, could this not be poetry anyway, without my knowing or believing it, making intelligible one of the secrets of language? and wouldn't I then have a vocation for being a writer, since a writer, no doubt, is only someone who is inspired by language?²

Novalis formulates some kind of modern poetics in his assertion of linguistic autonomy. When I quote his text, it has to do with his somewhat contradictory and rough-hewn characterisation of language. Language, we are told, is both unpredictably unruly, and a perfect, systematic mirror of the relationships in the physical world, and this is exactly what is supposed to make it suited for an employment guided by inspiration and intuition—a kind of instinctive inclination for being absorbed by language. According to Novalis, the result is different depending on whether the person speaking or writing (he does not make a distinction between speech and

writing) is prepared to follow the ideal nature of language or if he thinks that it, by necessity, has to convey limited, useful knowledge about things. On the one hand, the constraint of language determines work with it in its untamed state (the author is born), while on the other, language expresses its refractory character, which only seemingly can be controlled. It seems as if these two experiences are specific to two different kinds of people and talents; let us call them the poet-artist and the critic. But there is room for both in Novalis's experience of working with language, and in order to reach the rank of the first and higher kind, he takes recourse to a refined kind of irony against his pretensions of defining the essence of poetry. This transition is critical. This reveals that the obsession with language is existentially grounded and not only an expression of an extant intuition of the essence of language. It is on this foundation that writing becomes a work where the aspiration to come to terms with language dominates the linguistic act. The language that is supposed to be at hand in speech without obligation has, in fact, a utopian magnitude that the author reaches for with all his spiritual powers, a purposeful act that is projected on the image of game and sensual devotion.

There seems to be no peaceful relationship with language, but instead a continuous dream of attaining such a state. To use one's powers in an artistic project must, as far as I can see, be connected to a considerable deal of negative experiences of this dependence on language. Strictly speaking, we are here dealing with our complicated relation with what it means to be oneself or to be "something" in general. To the

same extent as looks and manners, speech and writing are markers of identity—but they were not supposed to be mere ways, but *expressions*—transcendence. For anyone, the necessity to speak may suddenly reveal its negative side and become a reminder of gruesome limitations and restraint. I think we have all had the modern experience of hearing a recording of one's own voice and felt how language, which was supposed to express what one had in mind, joins itself on to a number of unintended external characteristics that seem to have condensed into some kind of dialect, which I don't recognise as me. As a consequence, one may be hit by a kind of language regret. One wishes that one had not been so eager to communicate, that, in the realisation of the linguistic superstructure, one had only exemplified neutral dignity. Secretly one begins to prepare one's withdrawal from the verbal community. Two thoughts go through the mind, one about annihilation—a small suicide—the other about starting all over again and once and for all living up to one's ideals and never again being let down by language. In such a situation, one may be motivated to dissociate oneself from language in its trivial, social suavity and concentrate on its formal level, or even on a level above its formality, and with a sovereign gesture take control of one's own destiny. The attentiveness that is required in this decision makes possible a re-entry in the present moment without being superficial. If it can be maintained that poetry, in the broadest possible sense of the word, realises something inherent in language, it is because it removes language from an area where it produces new propositions, only

changing slowly, to an experimental area where a new language can come into being instantaneously. Consequently, language allows—and does not allow—a language “for me.” This language is the object of neglect, which is why it has to be claimed continuously.

P.S.

The text above is an extended revision of a shorter script that I brought to a class at the Malmö Art Academy. The changes can be seen as justified insofar as they represent digressions I made at the original reading and, especially, the lively exchange of opinions that ensued. This reference to conditions for the reader to be aware of should of course not conceal what are simple excuses. I have improved upon my text—as a result of the sense of irony that irremediably sticks to the subject of language. I don't think I have ever had a feeling of having done such a lousy job as a lecturer as when I left the school building of Mellersta Förstadsskolan, where the Academy is housed, and trudged along Föreningsgatan. Certainly, I had said one or two true things, but they bathed in the merciless light of the omissions that stopped me from mastering the subject.



Franz Gareis, Portrait of Novalis, circa 1799

1
(1772–1801).

Novalis: Friedrich Leopold von Hardenberg

2
ed, Friedrich Schlegel and Ludwig Tieck (Berlin: n.p., 1802), 120–22.

Mark Kremer

1997

This text, accompanied by slide projections, was presented as a lecture at Malmö Art Academy in 1997 and published in the Art Academy's Yearbook 1996–1997 under the title "Just What Is It that Makes Today's Bodies So Lucid, So Prolific?" Republished by permission of the author.

My talk deals with an issue that from 1990 onwards received a lot of attention in the critical discourse on contemporary art. The issue could be described as the re-enactment of certain visual motifs that were part of 1970s performance art. This re-enactment occurs in what I, for the time being, will call the "performance-related work" of a number of younger artists who entered the art scene in Europe and to a lesser extent North America around 1990. The appreciation of this development varies. The art historian Benjamin H.D. Buchloh, for example, argues that it all comes down to a spectacularisation of practices from the 1960s and '70s, such as those of Fluxus artists, with their interest in the transient event and ephemeral artistic utterances in the

world.¹ Other critics, on the contrary, cherish the link of this recent art to developments in the 1970s. They point out that today's artists seem to have similar interests in, for instance, process-oriented art, context-specific installations outside galleries and museums, and, in general, the reciprocity between art and the world. Many years ago, the art critic Lawrence Alloway, for that matter, talked about the "expanding work of art" when addressing practices that evolved in the 1960s and '70s (he juxtaposed these with the practices of painting and sculpture that were more prevalent at the time). Who is right when it comes to the current development: the pessimists, who say that we have seen it all before—and in more original art—or the optimists, who take

pleasure in the affinity to an earlier epic art era that today's artists seem to put forward, thus pushing aside the evil era of 1980s art, which supposedly was only about the money? Some artists that I will talk about today have acknowledged an indebtedness to practices from the 1970s. Studying their work, one can find substantial evidence of a relation to early performance art. This is what I will do. But in the first instance, looking at current performance-related work, my attention was drawn by what seemed to be, to me, mere replay of motifs and motivations from the 1970s.

1.

Some years ago, while attending a conference where members of art communities from all over the world had come together to talk about the current state of things in contemporary art, one evening a group of participants left the meeting and ventured to the outskirts of the city of Stockholm. There, in some deserted building that temporarily was a home base for poets, painters, musicians, and peculiar other talents, various artworks including video and film projections and live art were to be presented. I was among the people who had chosen to take the trip, and without distorting the truth too much, I can say we were rather excited at the prospect of seeing an art spectacle after all the scholarly musings. But, when witnessing the first live act—two youngsters, boys in their twenties, were indulging themselves in a sadomasochistic act in a bare

room reeking of vomit—we realised that our expectations had been too high. The boys were kicking ass: one stood behind the other, kneeling on the floor, pants down, receiving, on his butt, kicks from his companion, who made him crawl through the room like a dog. The picture was probably intended as an appetiser, offering morbid amusement until, so I presumed at the time, spectacles of a more lofty kind would erase the memory of a charade. And yet, this did not happen. In spite of the events that were presented later that night, the ghastly image of the boys in their carnal tangle has stayed with me since then, and from time to time it crops up like a phantom paying me an unexpected call.

What is it that makes this image so persistent? Why does it keep on coming back? Its vile and unattractive appearance—however strongly a squat mien may imprint itself on the memory of a susceptible person—cannot explain the ineradicability of this image in a satisfactory way. That leads me to look for a more profound explanation. Let us focus again at the act in question. What I see before my mind's eye is the depiction of a phrase, "kicking ass," with its particular connotations. This act could be understood as some kind of sequel to the performances of the 1970s, in which verbal expressions, such as proverbs, were visually rephrased by artists who, in the performance, often looked like stick figures almost devoid of their own will. However, the act of the boys also has a lot of aspects that

contradict this reading. The youngsters performed a “poor” spectacle, more *representative* of terror in inter-relationships than showing the real thing, conveying the hard emotions. There was irony in the air, non-belief! Somehow their gestures seemed prescribed by signals coming from a distant source, which rather gave the sensation of an after-image. Lack of structure made it impossible to experience the act as a rite of passage—the objective of many performances in the 1970s. In short, the performance of the two boys suffered from a flawed command of a visual language, and hence a viewer obtained the feeling of witnessing an event in which youngsters were simply acting out their exhibitionism. In their exposition of unprocessed affects, we can observe a crucial difference in the early performances.

To refresh our memories, let me offer this example of the Dutch artist Pieter Laurens Mol, who made a small number of performances in which one can discern the influence that Fluxus had on him. In 1975, Mol realised an act in the seclusion of his studio, where he, dressed in white overalls, threw himself on the floor repeatedly, to cleanse it with his body. The camera was the only witness as Mol visualised a twisted poetic phrase: *Einmal Schnell mit Mir Selber den Boden Fegen* (To wipe the floor for a change, 1975–76). His act, like many early performances, was a solo adventure in which an artist painstakingly choreographed himself for the sake of testing bodily limits. Only at a later stage could the public

take notice of an enterprise that —by then—would have transformed into a stylised momentum.

In the 1970s, many performances were executed in peripheral places by artists who were not *a priori* concerned about public exposure. They would record their actions solely for themselves, because they regarded them as highly individual, and in many cases even didn’t consider them as works to be made public. The difference of the current performance art, compared to acts from the 1970s, is indeed a matter of public address. The curator Daniel Birnbaum writes, “The exposure is of a completely different type: it is not about the lonely space of the lyric poem, but about a kind of total visuality that is rooted in the electronic visual media.”² Birnbaum’s distinction is crucial, but for one objection: it doesn’t take notice of *the* condition that determines the nature of a lot of current work that is produced under the label “performance art.” Today’s world is one of cultural feedback! And today’s art is the substantiation of a lack: artists realise acts whose essence is derived from performances of the 1970s, which they got to know via visual and verbal records, but did not experience.

The 1990s manifest the return of visual and other vocabularies from the 1960s and ’70s in many cultural fields: film, design, music, fashion ... The omnipresence of information leads to the emergence of odd phenomena. In a future book on twentieth-century art, one chapter simply will have to be

dedicated to the motif of repetition. One example is the return of the spectre of the “bed pieces” of Yoko Ono and John Lennon (*Bed-in for Peace*, 1969), Chris Burden (*Bed Piece*, 1972; *Oh, Dracula*, 1974), and Marina Abramović and Ulay (*Communist Body / Capitalist Body*, 1979) in performance-related work in the 1990s, by artists like Aernout Mik (*Project for La Vie Conference Centre*, 1993), Elin Wikström (*What would happen if everybody would act this way?*, 1993), and Janine Antoni (*Slumber*, 1994). At the end of the century, it seems to be crucial to decide which images one should rescue and bring into the next millennium. Everybody looks beyond 1999 in his or her own way: the boys in Stockholm, who are perhaps hostages of a cherished picture they want to reanimate; critics who try to write new things on current performance practices but are meanwhile holding on to old ideas about the genre; and even 1970s artist Marina Abramović, who wants to reperform a number of acts that were originally executed by Vito Acconci, Chris Burden, Dennis Oppenheim, and Gina Pane.³

Other artists are redoing their own performances. A 1996 catalogue of such instances could mention Matt Mullican, who in Brussels remounted an early performance work in which he subjects himself to hypnosis; Dan Graham, who in Vienna redid his *Performer / Audience / Mirror of 1975* (I will return to this piece later); and Marina Abramović and Ulay, who on November 30, the birthday that they share, redid a performance in

which they stand still to the sounds of a tango, undoing this static pose when the music comes to an end. The catalogue could also mention Mike Kelley and Paul McCarthy, who remade pivotal work by Vito Acconci, an artist they admire (*Fresh Acconci*, 1995). And it could mention the video of a certain Dennis Bellone, a New York artist who redid, in slapstick mode, some famous *Aktionen* of a European precursor of performance art, Joseph Beuys, pulling a coat over his head as a tent and talking in a small apartment to his cat—thus referring to Beuys’s piece *I Like America and America Likes Me* (1974), in which Beuys shacked up with a coyote. The title of Bellone’s piece, *Joseph Beuys Is Underrated* (1993–96), comes at a time when, with Beuys being dead, the urgency of his message is fading away (plus it also refers to a sculptural piece by Beuys himself: *The Silence of Marcel Duchamp Is Overrated*, 1964).

2.

Lately we have seen an increase of critical publications in which the visual language of today’s art is viewed as an externalisation, at times a somatic one, of a crisis of the postmodern subject. The difficulty human beings experience in connecting with the world has, since around 1990, been addressed in work that depicts reality in a confronting way. The American art critic Hal Foster introduced the term “traumatic realism” to talk about this work. With the term, he addresses in particular the transgressions depicted in work

by artists such as Mike Kelley, Cindy Sherman, and John Miller. His argument is that these artists—through their depictions of the grotesque body, the vulnerable body, or the body exposed to forces that cannot be controlled—give us tools to confront the pain of our era (or our own pain). He argues that people tend to suppress their discontent with their culture, and that art can undo this denial through a repetition of instances that bring the suppressed to the surface again. Foster borrows the term “traumatic realism” from the psychoanalyst Jacques Lacan, who, in the early 1960s, defined the traumatic as “a missed encounter with the real.”⁴ Foster’s idea points to one of today’s crucial issues: the lack in our relation with the world. One example is the current information technology. On the one hand, we have at our disposal a multitude of highly developed tools to reach out into the reality around us; on the other, we often feel that a huge gap is separating us from it. A doctor making a diagnosis of the condition of our culture would certainly put forward the case that there is a problem in the sphere of communication.

The huge increase in electronic communication means an age-old human skill is getting cornered: the ability to tune our messages in a refined way and get them across with the same acuteness. With regard to contemporary art, I have my doubts about the fact that, in the work of quite a lot of artists, I encounter visual languages with a blunt directness, derivative of the

ways of television and other news media. This work provides us with information, but does it also convey experience? The problem I just mentioned has been brought up before. This is a recurrent question in modern thought as far back as the 1930s, when Walter Benjamin wrote a short and terse observation on the level of estrangement caused by an ever growing army of apparatuses that bring all kinds of information within our reach. Central to Benjamin’s text is the notion of impoverished experience. Ultimately, it is the result of the forces of the progress of modern society. Benjamin starts his account with the example of the newspapers that bring us each morning the latest information on what’s happening in the world. Yet, so he says, in our lives, we are short of wonderful stories! As a counterbalance, Benjamin retells the story of the Egyptian pharaoh Psammenitus as it was written down by Herodotus, the ancient Greek historian, in his chronicle of ancient times.⁵

Psammenitus, king of the Egyptians, after having been taken prisoner by Cambyses, who was the king of the triumphant Persians, was subjected to public humiliation. Cambyses ordered that the Egyptian pharaoh should be put in a place where he would face the Persian triumphal procession. Cambyses had it so arranged that the prisoner first saw his daughter moving past, now turned into a maidservant, carrying her pitcher to the well. While all the other Egyptians shed tears over the sight, Psammenitus stood

motionless, his eyes fixed on the ground. And he continued doing so when soon thereafter in front of him his son, a rope around his neck and a horse bit in his mouth, was led to the place of execution. However, the moment Psammenitus saw one of his former servants in the line of prisoners, an old man who used to sit at his table, now reduced to poverty, he struck his head with both his fists and displayed all signs of grief.

This tale, says Benjamin, contains the secret of the true story: it doesn't exhaust itself. It saves its power, the core within, so that it may unfold itself later. The French philosopher Michel de Montaigne returned to the story of this Egyptian king, following Herodotus. Montaigne asks: "Why is it that the king begins to wail when he sees the old valet, why not before?" Montaigne answers: "He was by then filled with grief; this small addition was enough to take his defences down." But other readings are also possible. Benjamin tells us about a gathering of his friends, on which occasion he asked them what they thought of the king's behaviour. One friend argued: "The king is not moved by the fate of the kingly; that is his own." Another one: "Much on stage touches us that doesn't in our lives; to the king the servant is merely an actor." And the third one: "Intense grief gets stored within and only comes out with a relaxation. To the king, the view of the servant brought this relaxation." "If this story would have occurred today," a fourth one remarked, "next morning all newspapers would have

written: 'To Psammenitus, his servant was dearer than his children.'"

I have quoted Walter Benjamin at length. Firstly because I see a strong link between performance art and storytelling: storytelling plays a major role in its reception. What is left of these acts, once they are done, is often a sediment in text and pictures that appeals to memory. Consider how certain works—I'm thinking of acts by Vito Acconci, Chris Burden, Rebecca Horn, and so on—live on in our culture. The historical performances as artworks per se are no longer there; what remains is their stories. Secondly, Benjamin's account offers testimony that a story can be retold in such a way that its listeners experience a momentum or happening in the here and now—through words. But what about the images? What about live art that is being re-enacted? Can performances—live events whose visual manifestation in the 1970s was often limited to a singular time and place—be restaged *and* keep their original energy? Many early performers, as we know, did not raise this question. They were interested in singular events. But nowadays artists seem to approach the issue from a more liberal perspective. Think, for instance, of the American artist Janine Antoni, who, on several occasions, realised a performance called *Loving Care* (1992–95), in which she patiently and in a dedicated way painted the floor of a room in an art space with black rinse, using her long hair as a brush.⁶

Did Antoni use the weaknesses of an art world suffering from

nostalgia for the 1970s? Her performance *Loving Care*, through repeated acts of mopping a floor, seems to have evolved as a critical gesture inspired by 1970s feminist artists. Possibly she wanted to reclaim territory delineated by Yves Klein and his *Antropométries* (1960), for which he used the bodies of women as brushes. Possibly she wanted to present a case of rebellious *belle peinture*.⁷ A certain pleasure is what she shares with us. Antoni leaves the heavy feminist heritage behind, but this heritage also informs her work ... I discern a kind of blending of her performance with that of Klein—a jolly union of copy and original! The recent reception of performance art abolishes in fast pace the hierarchy between primal acts and secondary documents. Text, photographs, and video and film documents inform a young generation about historical art. A lot of performance art since 1990 has sprung from a desire to revivify a heritage: that of the secondary documents.

3.

I would like to proceed to a discussion of some recent works that, in my view, relate to 1970s performances and their existential mood, but that also undo this link through their particular lightness. However, there is another matter that I need to attend to first. Several critics have claimed that the renewed interest in performance art that started around 1990 came from a consensus of opinion that at the end of the 1980s art had

arrived at a dead end. As if it had lost its inner drive. And then some people started to consider performance art, because of the way it embodies protest against mainstream culture, as a model, an example, for the new art. A tricky view, of course, as art is always changing. It does seem relevant to ask: What happened to the radicality (read: political concern) of the performance artists? Where did it go? Did it suddenly vanish, like a thief in the night? To answer these questions, let us find out how one of the prominent 1970s performance artists is responding to this renaissance of performance art.

For that matter let's consider a recent performance by Ulay (Uwe Laysiepen). Ulay is known because of his performances with Marina Abramović. The artists called these acts *Relation Works*. After his collaboration with Abramović, Ulay continued as a solo artist active in photography and performance art, same as before his meeting with Abramović. My approach to the performance in question is complex, because it was part of Festival a/d Werf, an annual event in spring in Utrecht where theatre and art projects are shown in various spaces and sites throughout the Dutch town during a ten-day festival. I was the art curator there from 1994 to 1997).

On the night of May 25, 1995, Ulay presented a performance called *Der Begeisterer* (The animator). The work was a poignant proposal as to what performance art was in the past, and what it perhaps could be in the present.

Der Begeisterer took place in a lecture room of a former university building on the outskirts of Utrecht. This structure, erected at the beginning of the twentieth century, an impressive brick gestalt, was called the Rudolf Magnus Institute once, accommodating the Faculty of Medical Science. At the time of Ulay's performance, the place was approaching a dilapidated state. Now, picture yourself in front of the building in a row of visitors. It's a cold spring evening and with the others you are standing in a queue, not knowing what to expect, eager to get in. Next moment you enter, walk up the stairs, and are allowed into a lecture room that still bears all the signs of the teaching that took place there: an arrangement of benches rising like the seats of a theatre; a balcony looking towards a place where learned scholars stood, instructing students in the ways of their knowledge; and the impressive rostrum, a wooden table annex laboratory case, behind which speakers addressed the audience. While you take in this aura, you take a seat. Little by little, the room gets filled, and with many others, you wait until the person who handed you the flashlight at the back entrance of the lecture room, and bade you welcome, goes to the front and takes his place behind the rostrum. Various items have been prepared: skull, transistor, a chalice with blood, mortar, hammer, stone, and a bottle of water. Now that man walks to the front, switches off the fluorescents, turns on a desk lamp, and

starts to read a text from a paper that he's holding in his hands:

The American artist Vito Acconci started with body works in the 1970s. He announced the first work with a poster stating "body as space." From then on a wave of body works, body art and body language emerged across the USA and soon in Europe. A first generation of "body oriented" performance artists, like Chris Burden, Dennis Oppenheim, Charlemagne Palestine, Terry Fox amongst others, were to break with the object oriented tradition. Instead they came to terms with "life-like art," a word invented by Allan Kaprow, who himself belonged to the happening generation which, prior to performances of the 1970s, was active during the 1960s and into the 1970s. "Life-like art" as opposed to "art-like-art" focused on pure existential matter in which the body is central. The body implicating a reservoir in which all exists, a microcosmos with the same complexity as that of the macrocosmos. A vehicle by which to accumulate, to catalyse and to communicate. A space in permanent motion and permanent emotion, a biochemical laboratory, a psycho- and memory bank, a room to move. Body as space, imagine. The inner space of our body, thus the negative space. Both spaces we feel or sense, we can sense a cold breeze of air on our skin, while at the same

time feeling our comfortable body temperature. We can see a cruel action or violence by the sensory perception through our eyes and at the same time feel sordidness, which may sicken us. Emotion might be the bottom line, the basic climate for our conditions. Emotion is conditioning our well being or not being well, and emotion is subject to most disturbances. Emotion can get us in and out of our minds, for both are difficult to stabilize, speak control.⁸

After twenty minutes, Ulay's talk ended with a recapitulation of the rules that he and Marina Abramović set themselves as they began to realise their *Relation Works* in 1976: no fixed living space, permanent movement; no predetermined ideas in anticipation of the time, place, and location where the performance would be held; no rehearsals, no repetition; the aspiration to create something unexpected.

Then the second part of the performance began. The academic lecture changed into a poetic reading in which Ulay prepared the public—and himself—for what was going to happen next. "I will turn into the model of my reading," he said at some point. Prior to the execution of a succession of acts with a ritual tenor, Ulay invited his assistants, who were sitting in the front row, to come forward. Eight young women, dressed in black miniskirts, each with a pair of cymbals in her hands, sat down on chairs placed left and right

of the rostrum. And they almost immediately began to send soft waves of music through the room. Ulay now proceeded with the ritual. With the hammer, he coolly and systematically crushed the skull; he destroyed the transistor, which, a moment before had been playing classical music, and grinded the pieces to powder in a mortar. Then he put the pulverised organic and manufactured matter in a bottle and added blood to the particles.

The third part of Ulay's performance began when all the lights were turned off. Quietly, Ulay undressed, walked around the rostrum, and stepped on it, striking a pose with his back turned to the audience. In his right hand, he took the bottle with the compound of blood and the other particles, putting it over his head. Dozens of flickering flashlights illuminated the artist in the shape of a classical sculpture. The young women by now were producing a music that at times was unbearable. Repeatedly, Ulay poured trickles of the liquid compound on his head. Thin red lines of blood emerged on his back: a human "drip painting." On the whole, Ulay stood on the rostrum for almost an hour and a half. The audience responded strongly. At a certain point, having become restless to an almost unbearable degree, people started to throw paper airplanes; soon after that, they were clapping, stamping, and yelling. Always there was one flashlight on. But when many lights were finally switched off, and the women with the cymbals were too

tired to continue making any more music, Ulay stepped down from the rostrum. Slowly he pulled his feet out of the pooled blood on the platform, bent his body, and descended. When his feet touched the floor, those still present in the lecture room could hear the cracking of his bones. He only turned around and paid reverence.

4.

In a talk that I gave last year I presented some ideas about this work.⁹ I proposed that Ulay's work regauges the meaning of performance art: his work reminded a public without a direct experience of 1970s live actions of its essential traits. First, in choosing to make a new work, Ulay pointed out that we should perhaps speculate less about the history of performance art, since so many of the early performers are still around, artists who can show and tell. Second, Ulay's act can be positively related to the recent work of younger artists. His performance in Utrecht regauged the meaning of performance art in different ways.

One, his work implied a critique of painting and sculpture—by addressing their limitations with imagery derived from these arts! His act was in tune with the iconoclasm of performers like Yves Klein, who exposed the limitations of painting in his live acts, particularly in his staged photograph *Le peintre de l'espace se jette dans le vide* (The painter of space throws himself into the void), printed in a newspaper on November 27, 1960, that was produced by the

artist himself. The attempt to break the static nature of a picture can also be seen in Ulay's act, which exposed the limitations of sculpture, notably its insufficiency to depict life in a manner that does it justice.

Secondly, Ulay's act invoked the exchange between performer and audience, at various levels. At a certain point, a switching of roles occurred, as a formerly passive public began to take part in an active way, becoming the animator. The shift from subject to object (and vice versa) befalling performer and audience is characteristic of many body-oriented performances of the 1970s.

And, finally, noteworthy is the building up of Ulay's performance in three sequences: lecture on body art and its origins, poetic reading, and nude act. These parts of the performance relate to mind states of rationality, susceptibility, and surrender. Form journey of the mind to rite of passage!

Ulay realised the final episode of his act in the dark. The framing of this part is remarkable: the subdued mood of this sequence strongly contradicts the aspiration for total visibility that Daniel Birnbaum wrote about. In the image of the naked man, his back turned to the audience, there was a stillness that somehow reminds me of the unemphatical presence of the early performers. With Ulay, the image of the man became a picture that seemed to be there almost for itself, as if it was separate from its surroundings. Can one presume that Ulay intended his work to end as a kind of still life

that—given the flashlights' limited battery power—would gradually fade away?

In the talk I gave last year, I proposed that the ephemeral quality of the last part of Ulay's act connects with recent performance-related work. I am now less sure of that idea. Ulay's act was based on opposition. *Vis-à-vis* the public he performed an act that was monumental in scale. That the work depicted the monumental as an illusion, a man-made construct, does not alter the fact that he created a confrontation with his public. His performance was an act of opposition.

But we can relate Ulay's act to performance-related work that involves dealing with pain. Historical performance art has many examples of acts in which emotions such as pain, anger, and anxiety are imagined in a very pure and direct manner. Let me present a few specimens of current performance-related work that can be grasped as visualisations of such emotions.

The Dutch artist Job Koelewijn in 1993 produced a work with the motif of voluntary, self-elected imprisonment. He made a wooden box of five sides, twenty-five by twenty-five centimetres, covering these with mirrors to reflect the immediate surroundings. Occasionally he would put this on as headgear. In this way, impulses of the world would bounce off the cap, while at the same time he was in the midst of them. A colour photograph depicts the artist wearing a brown coat. It is autumn, he is in a forest, the mirrored cap

on his head, the object indicating the dividing line between the artist's persona and the outside.

The Spanish artist Pepe Espaliú, who died in 1993 due to AIDS, in the last years of his life did a performance at the exhibition *Sonsbeek 93* in Arnhem. High up on a tree, he slowly undressed on a wooden platform, showing his emaciated body to the spectators. As he put his clothes aside, the platform started to resemble a nest, where he could finally put his body to rest. Thus in this act a kind of exorcism emerged, perhaps as an attempt to undo rage about being trapped in a doomed body.

The American artist Stephen Shanabrook in 1995 realised a performance that he recorded on 8 mm film. *Bandaged* took place on a sunny day in San Ygnacio, Texas, during which the artist wrapped pink candy floss around his hands, took a walk in the park, and lay down on the grass, striking a pose as if he had dropped dead. As the floss melted, his hands began to look like wounded flesh. Inquisitive ants taking delight in the sugar finally put an end to the action.

Although these works address the sadness in our lives, it's important to distinguish the lightness that prevails here. A lucid element appears in them, as if the body itself becomes transparent.

5.

I want to make a final remark on Ulay's performance. I defined several aspects of his act that relate to historical features of performance art: a critique of sculpture; the role switch

between performer and public; the transitional element (rite of passage); the stillness that remained in the end as an introspective mood. But there is one feature that I did not mention yet. What I find really contemporary about Ulay's performance is his stylised hesitation with regard to the execution of his performance. The energy and time he invested in the preparatory stages can be read symbolically. As if Ulay was asking the Gods of Performance Art for directions, so as to do the right thing ... The academic lecture and the poetic reading seem in retrospect as exorcisms of sorts, disciplined attempts to get rid of a surplus of experience, or to cast this aside and regain the innocence required for the fabrication of a work that does not yet exist in the world.

Such contemplation on the act of creation: it is a subject in contemporary art, and especially in works that want to establish a relation with art tradition. An outstanding case is *Passion*, the film by Jean-Luc Godard from 1982, featuring a film director who is reconstructing paintings by Rembrandt, El Greco, Francisco Goya, Jean-Auguste-Dominique Ingres, and Eugène Delacroix, among others, recreating them in the form of 3D tableaux with actors. His wants to film the spatial scenes and go into the paintings with the camera, to discover their inner life. Godard uses the figure of the troubled film director to investigate the question: Can cinema extract artworks from their history and transpose them to the present? He wants to activate

the power of the works! Godard's answer is ambiguous. *Passion* is the tale of an artistic impasse. At a certain point, the ambitious film project comes to a halt as problems accumulate: there is an issue with the lighting of the 3D scenes that makes it impossible to get the right shots; there are huge financial obstacles; there's a strike in a local factory, which means that those factory people who have been engaged to perform as actors or extras in the film in their spare time cannot come to the set anymore—they have to stick with their strike project! Plus a love affair develops between the filmmaker and the conductress of the strike, played by a stuttering Isabelle Huppert, who likes to quote Karl Marx ... And so, our film dissolves into fragments of stories, putting aside the grand narratives whose live textures it wanted to recreate. And the prosaic conditions on which the production of an artwork depends are exposed. Indirectly, in a humorous manner, the film tackles the artistic and worldly issues that all artists (including the makers of the director's paintings) face when making their works.

I have dwelled a bit on Godard's film because I see a resemblance between the re-enactment of historical paintings in *Passion* — Rembrandt's *Night Watch* (1642), Goya's *Tres de Mayo* (1814), Ingres's *Turkish Bath* (1863)—and a subcutaneous element in Ulay's *Begeisterer*. Ulay and Abramović's *Relation Works* are present as a kind of second layer in the piece! *Der Begeisterer* was

not a reconstruction of their work, but it was a commemoration. Consider, for example, their performance *Imponderabilia* (which means “things that are not weighable”), executed in Bologna, Italy, in 1977. Ulay and Abramović stood in the entrance of the Galleria Comunale d’Arte Moderna, where an art fair was being held, facing each other. Both were naked. Visitors to the fair had to pass through their human gate.

6.

It is time to get back to my earlier question: What happened to the radicality of the pioneers, the first performance artists? Is it true, as people today sometimes say, that young artists don’t take a political stance anymore? Is there no work with a mission in the present? Then again, “political engagement” is almost a synonym for the philosophical-artistic climate of the 1960s and ’70s. In those years, progressive artists were, by definition, political artists. “As a medium, performance art was initially intensely political in orientation.” This is what Henry M. Sayre writes in *The Object of Performance: The American Avant-Garde since 1970*.¹⁰ The American scholar locates the rise of performance art in the US against the background of the emergence of a broad counterculture that saw various events such as the 1967 San Francisco Human Be-In in Golden Gate Park or the Angry Arts Week, a manifestation in New York organised that same year as a protest against the Vietnam War.

Because the term “political” is burdened with historical meaning, it is not so easy to use in the current debate, for contemporary art. Also, “politics” is not easy to identify; it has transformed itself into an infinitely ramified body whose members pursue dispersed interests. The philosopher Michel Foucault remarked around 1968 that politics had disappeared in society’s strata. In the 1970s, developments took place that came down to a “goodbye to ideology.” At a certain point, there was a shift from an idealistic attitude toward life and a belief in the collective enterprise, to an individualist approach to life. This shift can be seen in the “bed pieces” that I mentioned. There is a difference between the overtly politically concerned *Bed-in* of Yoko Ono and John Lennon and the distant and doubtful mood that permeated the act of Marina Abramović and Ulay. Both works addressed issues that had huge impact on many people, respectively the Vietnam War and the psychic deformations caused by communism and capitalism. But the way these matters were taken up differs. Ono and Lennon still believed in the possibility of changing the world for the good, while in Ulay and Abramović’s act there was an acknowledgement of the individual’s powerlessness to do so. A similar resignation was already part of Chris Burden’s acts of the 1970s, which I read as stagings of mythical enterprises, and suffering in an environment that does not seem to care.

Elin Wikström, Aernout Mik, and Janine Antoni do not address the world at large. Wikström and Mik created performative works in the micro-cultures of a supermarket and a conference centre. Also Antoni's *Slumber*, the transfer of the inner motions of a woman asleep in the night—via an electroencephalogram—onto a weaving that she made during the day does not seem to take a straightforward oppositional political stance. These works simply provided imaginaries of sleep and dreams. Mik inserted “sleepers” in the midst of a building in Utrecht where people gather and work. He thought of this tableau vivant as a reinforcement of a dreamlike daily atmosphere. Wikström placed her bed in a supermarket in Malmö as an act of refusal. She stayed put the whole day, above her head a red digital sign displaying the words:

One day I woke up feeling sleepy and in a bad mood. I pulled the cover over my head, for I did not want to get up, look around or talk to anybody. Under the cover I said to myself: “I am going to lie like this, without moving, without saying a word, as long as I feel like it. I’m not going to do anything, just close my eyes and let my thoughts wander. What would happen if everybody did that?”

These works are lucid but are not without critical potential. They act like mirrors reflecting our world. Sometimes it's revealed with

humour. The figures in these works penetrate semiclosed systems and expose—through a contrasting presence—the peculiarity of these orders. The works unfold their own narrative amid daily life, bringing about odd displacements in the reason of the day.

Lately, such light-heartedness can be seen in a type of image that is reinvented as we speak: the group portrait. This genre offers new possibilities. The optimism about the collective endeavour may be over, yet we need images in which people stand and come together. It can be that we're not united by one idea or ideal but that we have a lot in common. Let me introduce some of these group portraits. An important reference is Dan Graham's 1977 work *Performer / Audience / Mirror*. Perception and cognition were the themes of this piece in which the artist, in four successive stages, described the external features and movements of people—he saw them in a mirror—and those of himself, as well as the internal attitudes that he believed to be signified by all that. While Graham made an X-ray or an archaeological study of the group and its behaviour, younger artists today treat the subject with humour and irony. They seem even more attracted to the idea of its illusion.

One example is Aernout Mik's *Langer oder liegender Affe* (Long or reclining monkey, 1996). The work was installed in the public space of the German town of Münster, on a sidewalk next to an austere 1970s flat. Perhaps the title refers

to outward form: an aluminium sluice reminiscent of those used in airports for passengers boarding planes. In a similar way, the visitor had to board or enter this piece. Midway in the construction, a video projection was played, of boys and girls—punks—gathered in the open. They hang out, smoke cigarettes, drink beer, talk. At intervals, this behaviour is punctuated by involuntary movements: facial muscles are forced into animalistic grimaces, or sudden eruptions like swinging a rattle in the air. These acts alternate with sessions in which they undress, trade clothes, and get dressed once more, putting on pants and sweaters that do not exactly fit. Thinking about this work, it seems as if different patterns of behaviour are thrown into the mix, merging the everyday with the primitive that is still part of our lives. At the time, muffled sounds reached your ear from behind the projection screen: the youngsters were really there!

(-): *HumaTiCks of the Present* :-[], an act by Arthur Elsenaar at the 1994 Festival a/d Werf, is a second example. Elsenaar presented his playful piece around Neude Square in Utrecht, in the midst of relaxed festival visitors. His act featured five characters with mechanised bodies that reacted to sound. When these people were, for example, spoken to, they automatically made a pre-scripted movement. This was put in motion via an electrode that, fixed to a part of their body, sent surges to muscles. These involuntary movements could be read as strong emotions.

There was a lady who turned her head coquettishly to one side. A girl threw her head back in a strong air of haughtiness. A third one, looking like a rogue, raised his arm in a jovial gesture, giving you a big wink. On the last evening of the festival, the five characters came together on stage.

Next I will mention a work by Pierre Huyghe that was recently presented in Paris. *Dubbing* (1995) consisted of a large projection of an event where around twenty people are watching a film that we cannot see but the dialogue of which is made visible through typed words at the bottom of the screen. Huyghe instructed the spectators of the film to replicate the texts said by the actors. When one watches this work, one sees an unusual scene of a gradual shift from the formless—people who don't make contact—to a portrait of a group who accomplish a task. I found this work impressive. In a playful way, it persuaded you to become optimistic about the things people can do together!

Compagnie de compagnie (Company of company), an art project by Alicia Framis for Festival a/d Werf in 1996, was a functional agency. In the hall of the main train station in Utrecht, a yellow kiosk was set up. Here, a service was put on offer. Festival visitors could be accompanied by a pair of twins—identical twins were in ancient times the bringers of good fortune!—young men and women, on their way to a festival event. On their walks in the city, the festival visitors would not be alone. What most people probably

saw when approaching the kiosk was a portrait of beautiful twins. Perhaps the illusion of this work was the strongest feature! It reminds me of the spirit of the twentieth-century avant-garde, artists who saw their work as a tool to add beauty to everyday life.

My final example is Aernout Mik's contribution to the catalogue of the 1995 exhibition *Wild Walls*, held at the Stedelijk Museum in Amsterdam. It consists of two photos of museum guards sitting on the floor amid a constellation of scattered sugar cubes. Silly and unusual acts, guards who leave their role behind, freedom and anarchy!

Gestures, expressions, and body language, human encounters: the works of today's artists play them back as real projections (or mirages). Sometimes an image is literally triggered through mechanical or electrical devices. At surface value, these images inform us about the "human project"—in ways that resemble Dan Graham's performance. Like Graham in his piece, these artists conjure up a group portrait. But instead of dissecting it, they show it tongue-in-cheek, an ideal undermined by irony.

7.

Maybe it's possible now, despite the limited number of works I've talked about, to answer the question I asked at the outset. What is the connection between performances of the 1970s and current performance-related art (and tableaux vivants)? I have

discussed the repetition of historical acts, in terms of somatic re-enactment (the "Stockholm boys"), conscious tribute to a tradition (Janine Antoni and the feminist heritage of performance art), and as a bridge to a past that may seem lost sometimes (Dennis Bellone with respect to Joseph Beuys).

I have also discussed other performance-related works. In my view, this work embodies not a spectacularisation of 1960s and '70s art but rather an at times lucid revision of a historical critical potential. I doubt if the connection of today's "performances" to that historical art comes from a similar interest of the artists in context, process, and politics. It seems as if these terms are more related to the past than to the present. What does seem crucial to me is that, today, artists are gauging the element of modern anxiety. Already the early performers did this in their solitary actions. But in their approach, a heavy heart was beating! Today's younger artists also expose problems of our era, but in the company of the suppressed laughter of the modern era, as the Russian literary theorist Mikhail Bakhtin called it. Hence in their work, a light tone prevails. They simply allow the problems to enter and take over their works, with a smile on their face.

Postscript, Summer 2020

Strange, this encounter with the real ... But, I am always someone else! After twenty-three years, I meet an author who is confused about his role. Art historian, storyteller, or art critic? This text presents an argument, or rather a question. It takes some detours, yes, it has some shortcomings. Yet, between the lines I feel the heart of a person who is enchanted by art! In 1997, I was an instructor in the Curatorial Programme at De Appel in Amsterdam, passing on knowledge, finding my way as to how to connect with young people. In this text, I miss artists' thoughts. At the time, I could have asked "my artists" about the early performers—as curator of Festival a/d Werf, I had easy access—integrating their ideas into my meditation. Apparently I preferred the distance ... Did I want to keep my enchantment intact?

Ulay's performance still touches me. Ulay died this year, in March. His act makes me feel real

urgency. For him, performance art was stone dead. He had to animate dead matter before he could do what he did. Funny that the subtext of his title escaped me at the time. *Der Begeisterer* (The animator) is of course a variation on a Hollywood fixture: *The Terminator* (1984).

One year after this talk, in 1998, I was teaching the workshop "Urban Angst" at Malmö Art Academy. Christian Andersson was one of its participants. At the end of the course he realised a performance in which he sat down in a glass box positioned in a corridor of the school. It was the type of glass used in police interrogation rooms. He could not see his spectators. But we could see him. It was a beautiful and terrifying sight. A man was looking at the world, without seeing us, in his eyes all the signs of expectation and vulnerability.

- 1 Benjamin H. D. Buchloh, in "The Reception of the Sixties: Round Table Discussion," *October*, no. 69 (Summer 1994): 15. Buchloh's criticism is aimed at *Loving Care* (1992–95), a performance by Janine Antoni that I will discuss later.
- 2 Daniel Birnbaum, "Visible/Invisible: Poetry, Television and the Body," *Siksi: The Nordic Art Review* 11, no. 2 (Summer 1996): 47–48.
- 3 Information provided to me by Lois Keidan, curator of live art at the Institute of Contemporary Art London, September 11, 1996.
- 4 Jacques Lacan, *The Four Fundamental Concepts of Psychoanalysis*, trans Alan Sheridan (New York: W.W. Norton, 1978), 50. Hal Foster mentions this source in his *The Return of the Real: The Avant-Garde at the End of the Century* (Cambridge, MA: MIT Press, 1996), 132.
- 5 Herodotus, *The Histories of Herodotus of Halicarnassus*, trans Harry Carter (London: Oxford University Press, 1962), 170–71. The account of Walter Benjamin, "Kunst zu erzählen" [Art of storytelling] can be found in *Walter Benjamin. Denkbilder* (Frankfurt am Main: Suhrkamp, 1994), 136–38. What follows hereafter is my translation of the German text, to which I added details as offered by Herodotus.
- 6 The first time Antoni realised *Loving Care* was at Anthony d'Offay. London, in 1992. Thereafter she performed her act in New York, Seoul, Amsterdam, Barcelona, Glasgow, and Dublin between 1992 and '95.
- 7 Benjamin Buchloh expressed a similar criticism when he accused Antoni of "a spectacularization of feminist theory ... and of Fluxus practices." In 1994, he claimed that *Loving Care* is a pastiche of a 1965 Fluxus performance by Shigeo Kubota; see "The Reception of the Sixties: Round Table Discussion." Somewhat later, the art historian and curator Juli Carson showed very convincingly that this is not the case. See Juli Carson, "Letter to the Editors," *October*, no. 71 (Winter 1995): 144–45.
- 8 Ulay, "Body as Space," unpublished text, Amsterdam, May 1995.
- 9 "Joy in Repetition" was the title of my talk. It was presented at *You Put Me High (Upon a Pedestal)*, a symposium on performance art that took place in Sackville, New Brunswick, Canada, November 11–17, 1996.
- 10 Henry M. Sayre, *The Object of Performance: The American Avant-Garde since 1970* (Chicago: University of Chicago Press, 1989), 13.

Two Instruction Pieces
by Leif Holmstrand
and a Documentation
Photo of a Seemingly
Unrelated Piece
Performed at
Zarya Ccenter for
Contemporary Art
in Vladivostok

2020

Leif Holmstrand

1. Past Tense (2020)

Spend five or six years at an art academy. Make sure it's a small one, with an international profile. Eat everything served to you, and demand more. Work with materials and ideas that surprise you, when possible. Listen to everyone, to everything. A multitude of critical voices are there for your enjoyment and progress. Love them all. Start your education when the school is young. Follow its development, be a part of it, and contribute when you can. Be angry if you have to, take every chance to be happy. If you develop schizophrenia, Malmö Art Academy will help you manage. If you are beaten and raped, Malmö Art Academy will offer you opportunities to heal in ways local psychiatric care cannot. Do not adapt. Do not conform. Enjoy every angle, every statement, every piece of advice. Make friends for life. Travel with them to Mexico City and visit the Museo Nacional de Antropología. Harvest delight in possibilities given to you that you never thought reachable. Make art. Make things happen. Leave school at an appropriate time. Remember and nourish. Build life and work. Cook your friends a nice meal. Be happy.

2. De Profundis, or From Above (2020)

See to it that the lighting has a friendly and inviting quality. It should also change, slowly, but never stop signalling safety and care.

Be many performers. Be different. Surround a seated audience, but keep a respectful distance and be as nice as you can in this situation.

Make sure the seated audience has a large amount of comfortable, old, dark pieces of furniture to inhabit, and a large number of red, pink, orange, and yellow pillows at hand.

Wear pastel-coloured veils over your bodies, wear green panties with different details and nothing else but lovely, fabulous black shoes and long black gloves.

Move like slow animals at the intersection of insect-mammal.

Concentrate on the difference between scent and smell for a while, continue the exploration of movement, and during these moves and relocations, each performer will add something personal to the growing odorama landscape, one by one. It could be perfume drops, the unpacking of lilies, the releasing of bakery loveliness, whatever.

Ask the audience where they draw the line between scent and smell, and reassure them that it is all right to like both. Welcome answers and other phrases as they appear, and maybe repeat them, yes, repeat them.

Let in a lot of fresh air, and a lot of outside sounds; reset the event.

Drain the odorama room and state that the imagined smell/scent of cookies and incense lingering in the hole, in the naughty absence of a loved one, precedes a soon-to-be return and reunion, a new kind of meeting and forging, the reversed little flower catastrophe, something within everyone's timeline and attention span, within everyday life of life, nothing special.

There's a bakery in Shinjuku called the Smell of Scandinavia, and now is a good time to enlighten the audience concerning this central issue.

Tell them to go there and touch each other, to sniff.

Let's all go there and touch each other, and sniff, because we want to, and because we have to.

I am not only a fruit of knowledge. I am bread. I am oatmeal in fat, sweet milk. I am all non-fruit, through and through. But other things will always call for our attention. An apple straight from the tree is not a bad thing.

Taste my juicy sinful apple tears of joy. Drink, friend, and I will drink from you.

Distance was never an issue. Let everyone know that distance was never an issue, and that it never will be. But keep all bodies apart, be very strict about this, maybe with black-and-white string, maybe with police barricades and large branches picked from the ground of the closest forest.

Say something about distance not being an issue because relation is humanity, air is humanity. Which is true and true nonsense. Never speak in full sentences, but try not to deliver fragments in a staccato fashion either; be softer and friendlier than that. Focus on air and breathing.

Ask many times if anyone would like to sing a refrain or a verse from a favourite song, or just a song they happen to remember. Try to sing along, but in a more monotonous and chanting way. Ask to hear the song fragments again and again. Learn the words. Chant and conjure.

Breathe each other's air while moving in slow motion, breathe slowly and carefully from greater and greater distances. Don't forget to behave like slow insect-mammals.

Switch places with the audience, but let people, tell people, to bring all pillows out onto the open floor and sit on them, or hold them, or both.

Continue not resembling humans. Climb furniture, rearrange furniture, while all performers speak, sing, and chant what they have learned, in overlapping fragments. Remember that you are insects, mammals, something in between.

Let the singing and chanting slowly turn into insect and animal sounds while climbing and rearranging in more and more complex patterns. Strike beautiful poses from time to time.

Make place for a naive attempt at art, full of shadows of gnomes and elves, dancing in the clearing.

Pull out containers or taped plastic bags with pastel-coloured paint, many different kinds, from the undersides or insides of furniture. Make sure beforehand that the paint is water based and doesn't have any heavy smells or scents.

A surprising kiss among the climbers will now surprise you all while everything becomes surprisingly darker in a surprisingly soothing way, darkness is not evil, care can embrace someone like you during the night as well as during the daytime, you'll be holding on to these plastic flower organs with paint or pastel seeds from very distant species and you'll be spreading the joy.

Warm laundry enters from above, lands between the audience and the performers. Mostly white duvets, white sheets, and white pillowcases.

See to it that the audience fills all duvets and pillowcases with all the pillows, and see to it that the audience throws the sheets and stuffed duvets and stuffed pillowcases on the furniture pile you inhabit and crawl upon. Make them put the police barricades and the branches and the black-and-white separating string there as well.

A warm day in an urban park, as the sun goes down, appears with ease. Choose a medium for this impression or a magic trick with care. Also for the following: A fox scurrying through a gay district. Three alien spaceships landing and the disembarking visitors bringing us thoughtful gifts. Two gentle and uneven winds blowing from two clear lakes through dense forests, making the veils you are wearing move from side to side in an enchanting way.

It is very important that you never stand still.

The soft afterglow of the morning after a party will now arrive. Signal this feeling.

And puncture some of the paint bags. Move, climb, sing, chant, talk. Spread paint.

A tangled system of roots will appear, maybe it was hidden under the scenography, maybe even under the floor, and it will make it possible for you to attach all the pieces of furniture and the other things to each

other, to let the roots root, to secure the structure and make climbing safer. The roots may be of any practical and available material, dirt coloured, soil coloured, terra di Sienna, raw or burnt umber.

Mulled wine will be served around this time, and a very worn-out tarot deck (Rider-Waite) will be handed out, card by card, while more and more bags of paint are punctured and carried around over the secured, root-bound mountain of furniture and sheets and stuffed duvets and stuffed pillowcases—and so on.

The paint must also come upon yourselves. Your voices must be heard.

A nice cup of tea will follow, many of them, and palm trees will be reported being seen at night, lit by the flickering, from-down-under rising, fluorescent, rainforest mushroom light. Yes. Voices as light from below. No more pain in the voices from below. Voices as candle eye-lights travelling through the palm tree dribbles of glitter-honey, through all the colourful veils of yours, through furniture, shoes, panties, through all uttered words or insect sounds or animal sounds.

You will be more and more quiet, more and more still, you will make yourselves comfortable and be quiet and still, fully quiet and fully still, and cinnamon and cardamom powder will fall from the ceiling while the upward-striving lights disappear. This special kind of light will have moved on, gone further, up from this place, this stage, setting, scenery, and a pleasant everyday sunshine will take its place.

Now, pay your respects, say goodbye, and wave.

3. Documentation photo of a seemingly unrelated piece performed at Zarya Center for Contemporary Art in Vladivostok called *Nonsense Translation* (Leif Holmstrand, 2018). Image courtesy of Vadim Martynenko.



Karin Hald

2020

This piece is part of the publication and exhibition *Lights, Camera, Reaction!* at c4 projects, Copenhagen, 2020, by Karin Hald. Republished by permission of the artist.

1.

Leave your house. Walk towards Fox-Amphoux in Provence. When you come up the mountain, and you can see the small village at the top, turn right on the small gravel road. After walking for about five to ten minutes, you will come across a small opening between the trees where stones have been placed. This is the entrance.

You are entering sacred ground, composed by Françoise, who was enlightened and then follow the calling, which was giving to her.

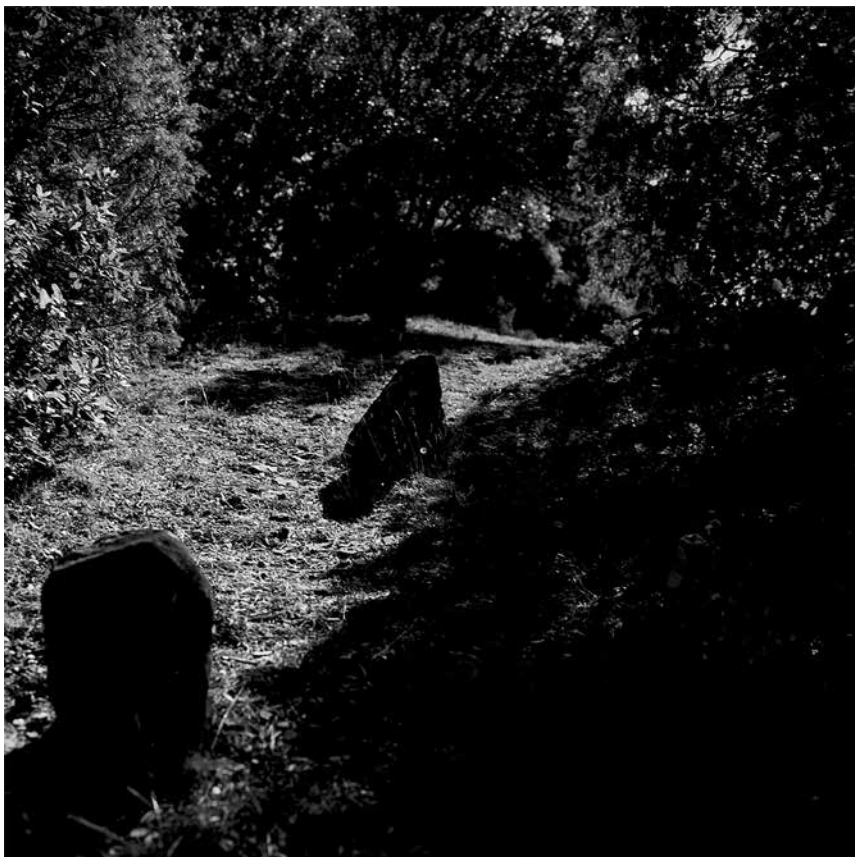

2.

The first thing you will see on the land is a stone bed, approximately seven by seven metres, made out of rocks of roughly the same size. Walk in the direction from which you entered over the rocks, as slowly as possible. For every metre, think of a chakra in your body—the first metre = the first chakra, and so forth.

Connect your body as a line between earth and sky.



3.

Walk down over the grounds, past the stone house on the right. Find the place where large, almost white rocks have been dug out from the ground. Françoise will have placed a large white cloth for you to lie down on and placed a small, white cloth to cover your eyes. Meditate on the experience of being with and on rocks, while your internal gaze is turned towards the sky.

Stay until you have an epiphany and/or you dissolve the idea of the dichotomy between you and the rocks.



4.

Follow the cairns that lead you left on the path around the house and out of the grounds. Build your own cairn if you feel like it.

Pick up a small rock, put it in your pocket, and walk home.



Ute Meta Bauer

2009

This text was first published in *Art School (Propositions for the 21st Century)*, edited by Steven Henry Madoff (Cambridge, MA: MIT Press, 2009). Reprinted by permission of the publisher and author.

Art schools and university studio art programs, previously free and open zones for experiments, have found themselves pulled further and further into the orbit of the art market. Art students have more knowledge of the market than ever before, and to “create” successful artists—which largely suggests commercial success as a career artist—has become a standard promise read in almost every mission statement and call for applications by MFA programs not only in the United States but around the world.

What may be more specific to the situation in the US is the very short route from the art school to the gallery to the collector’s walls. This may be the case in London too, but the very high tuition fees in the US put a certain pressure to succeed on both the institution and the student. Today’s strong market has made art

education red hot and an increasingly attractive field within education—and not only MFAs. In the expanding market of the culture industry, critical studies, curatorial studies, MAs in public art, and PhDs in artistic production have either been recently invented or have risen to new popularity. (The inevitable cooling, and just as inevitable reheating, of the market is not likely to cause the institutional structure to regress.)

This isn't in itself bad. The proliferation of these new, specialised programs interrupts the dominance of hundreds of years of the European master schools tradition that was established to select and form "the best." Or this would seem to be the case. A question that immediately arises is whether the influence of the market is inducing a different uniformity. Of course, another question to ask is where all of these art students are going to go when they leave their alma mater with a degree in their pocket.

As part of the selection process for a specific degree program, if you intend to invest so much in your art education, you want to know where the revenue will come from when you are finished with school and out in the world. But the pressure isn't only on the students. The pressure is on the art schools and programs to connect early with the art market and generate a smooth entry into the system while young artists are still under the school's umbrella. That is a major shift from even a decade ago. The debate then was about what that majority of art students would do who never reach the first stage of the magic "success" triangle of academy-gallery-museum. But with the globalisation of the market, the boom in biennials and art fairs around the world, and the rapid expansion of a new generation of collectors, the chance to catch a ride on the art carousel has increased enormously. The ambition to pass through the gate and gain access to this field of distinction for larger and larger numbers of fledgling artists has become a reality. There are more exhibitions taking place, more art institutions with their doors wide open, more new museums and *Kunsthallen* being founded, and more private collections welcoming the public than ever before. But was this what art students

and young artists were after, say, twenty-five years ago, when they asked for more visibility as they addressed the exclusive politics of major art institutions?

Today it feels as if the art market has replaced the music industry, with its annual top-of-the-pops and one-hit wonders. And although I appreciate the democratic component that almost everyone can be a producer of some kind today, I am not so sure that this is a good thing. If the art market now seems more integrated into the educational system than ever before, we have to ask what its far-flung biennials and fairs are providing. It is important to support access to discourse and to modes of production that we now find spread all over the world, just as I still believe that artistic practice is a critical contribution to the formation of societies. But the market embraces each new spot that pops up on the global map all too fast. Yesterday it was China, today it is India, and tomorrow Dubai and the Gulf. Who knows what it will be a year or two from now? And as much as I support this expansion of respect for and acceptance of artistic production in all parts of the world, the question is the degree of disciplined analysis, of filtering and criticality that this expansion has lacked. Instead of this, art has simply become a huge operating machine in need of skilled and “educated” labour — a neocolonialist approach that takes advantage of postcolonial ambitions.

This brings us back to art schools. Before the incursion of the market, art schools could still more easily be testing grounds for experimentation and innovation, including failure. But are they still places where you can discuss the meaning of artistic production within the larger field of culture, or, perhaps more precisely, debate what culture *is* today in such a globally expanded field of experience and how art schools have adapted to this fact? But have they indeed? And given this contested space of authority, can art schools truly help to negotiate and problematise what role art and its institutional apparatus play in our globalised and modified societies? It seems, on the one hand, that art students are allowed to do whatever they have in mind. Yet, what they have in mind is increasingly shaped, if

not dictated, by the allure of success in the market, which is to say that the wild growth of experiment is more and more subject to the biotope of uniformity that the market enforces. Perhaps this was always there—the same when a “master” taught his novices skills, techniques, and his own style as, today, when the market enforces its own means of determining quality, techniques, and styles. But isn’t it even more so now, with the endless output of colours, forms, two-dimensional works, voluminous installations, sparkling pixels, and the offer of so many diverse topics to fulfil the demands and desires of an “educated” consumer society that wishes to express its “fine distinction”?

Under these pressures, art students and art schools seem to be without any useful, utopian naivete. All kinds of strategies are incorporated to serve our post-naive system. Perhaps the most flagrant is the end-of-term “open studio,” which is advertised as an event that courts art dealers and collectors, replacing critics and curators, the global players of the 1990s. This is the reciprocity between the market and the academy. As art events have become part of the lifestyle, with substantial cash flow involved, there are huge demands for fresh artists, young curators, new terrains for biennials, galleries, and so on and so forth. It may feel as exciting as Paris showrooms during Fashion Week, but the question that we as educators and intellectuals need to address is what this reciprocity actually creates.

In his article “Bureaux de change,” curator Alex Farquharson addresses “new institutionalism,” referring to the number of high-profile freelance curators who have joined the “safe haven” of institutions for higher artistic education.² I don’t necessarily agree with his argument. To me there is no *outside* of the institution, no outside of the art market, and vice versa. The market is part of the discursive field, as educational institutions are too. The art world is and always has been a complex system, a field of constellations and interrelations; some are friendly to each other, some are of a more antagonistic nature. Traditionally, the critical field has distinguished itself from the commercial sector, but

the field has changed. These are not fixed configurations. Roles shift. The market brings both uniformity and proliferation, which means the opportunity for actors to decide on the coordinates of the positions and the directions in which they'll move. Indeed, institutions today represent far more positions than they did twenty-five years ago, because they have to address and attract a more diverse audience, if not many audiences.

When Farquharson brings up the topic of curators flirting with educational institutions, this too is not about an outside and an inside but about the shifting fields of education and commerce in relation to one another—and the larger effects brought into clear play. The commodification rampant in the art world has made it more difficult for curators to act within institutions as creative agents. It is the same for museum and *Kunsthalle* directors today, who are more occupied with management and fundraising activities than with working on shows or working directly with artists, as has been the case in the past. I do not want to criticise my colleagues in art institutions, but I want to express (and this I share with a number of my peers) a strong feeling of unease about the economic and political pressures that museum directors and curators increasingly face. And while art schools currently face the influence of the marketplace more strongly, by comparison they still seem to offer a kind of temporary refuge for those who want to sustain a more critical and discursive practice.

This doesn't mean that the migration into the art school environment that we see at the moment is simply a means of escape. The opposite could be said as well: that art students are getting ever more prepared for "real life" by professionals in the field, such as curators and critics. But the potential and pleasure of working with students and doing research in related fields shouldn't be underestimated either. My own motivation for shifting from my original training as an artist and stage designer to my practice as a curator and educator already seems dated. The exclusion of a younger generation of artists, specifically female, from mainstream art institutions in the 1980s was a motor for me and for my artist friends to generate something else. We were not completely

opposed to art institutions, but there was no space available for us, and what we saw exhibited often failed to address what mattered to us or to our discussions about art. Instead of complaining about this situation, we simply created our own formats and spaces, generating our own audiences—a typical do-it-yourself approach. We descended not only from visual arts but also from the fields of performance and theatre, film, music, and poetry. Today, with so much interdisciplinarity and the greater (though still unequal) acceptance of women in the art world, this seems far away.

It was not until later that I understood that art history isn't made in the garage; the art historical canon is to a certain extent still in the hands of the major museums (and their trustees), based on what they choose to collect, exhibit, and publish. But more and more, the market dictates what kind of art is produced and shown in art institutions, and the rapaciousness of its desire for the new discourages memory and deep criticality, while addressing cultural diversity and gender only in its search for novelty. Price and collecting prestige invent new types of segregation.

There is a need for serious debate within universities and other social institutions to focus on these issues in order to understand the major implications of this development. But for obvious reasons, those debates should also take place at art museums and at opinion-creating blockbusters like documenta (in Kassel, Germany); the biennials in Venice, São Paulo, Sydney, and New York (the Whitney); and the Carnegie International (in Pittsburgh). *Especially* at these places. They have the budgets, infrastructures, and media power to “correct” and rewrite art history, as they are the events at which the critics and opinion makers show up in vast numbers. But are we seeing these sorts of debates take place at these venues? Perhaps informally, but rarely as part of a regular public platform. A network of institutions addressing these issues would be of huge benefit. And closer to my main subject, what we need to see more in art schools is the development of alternative cultural stances to the predilections and short-term memory of the market.

I see my own teaching in art schools as a practice in line with curatorial work. The BBC's founding phrase, "Education, Information, Entertainment," is a healthy mix that is still a valid model. The relation between art and exhibitions, which offers the option to test situations and combinations and explore thoughts through works of art, is no less needed as a focus in art education. An exhibition is equal to a seminar for me; both formats produce a communicative space through artistic and intellectual means. Nothing is wrong with the involvement of students in exhibitions, but the idea behind such participation has to be made clear. It shouldn't be to create a showcase for students entering the market, or certainly not that alone.

When I studied art, being unpredictable was enough to prevent my fellow students and me from getting co-opted. I must have internalised this attitude, and in any case we were far from having a master plan to develop and manage our careers. Of course, it's also important to remember the practical lessons of any number of conceptual artists, such as Hans Haacke at the Cooper Union in New York and Michael Asher at the California Institute of the Arts, who were able to sustain their independence throughout the pressures of previous market booms because of the independence that their teaching positions provided. For a female artist, often the only way to survive was to become a teacher.

Of course, this isn't only about financial independence from the market. This is about the possibility and responsibility to transmit a specific notion of a critical artistic and cultural practice to a younger generation of artists, while giving teachers the distance necessary to remain cognisant of the market but not in thrall to it. As a curator within the academy, I'm always trying to find company to explore, discover, reflect, analyse, and share what I perceive in order to implement a correction through a multitude of voices— which is precisely what a curator does in the selection of works for an exhibition. Alongside the pressure to produce "successful" artists, the pressure has to remain to support the development of critical subjects.

This understanding, this continual generation of a public, communicative space within an institution for *education*, is still important to me. But the more the market encroaches, the more difficult this is to achieve. Perhaps to a certain degree this has been caused by curators entering the teaching field, bringing the dynamics of the market along with them. But it is clear that the fact of the omnipresence of the market means that art schools need to work on new ways of configuring and positioning themselves. Just as we have begun to see biennials reformulated as art schools, we must think about inverting this outside and inside of the market and the academy and think of a reverse practice that uses art fairs and the market more emphatically as educational tools and as the terrain for (counter)actions.

Of course, it is also true that other possibilities remain if we take a longer historical view. The idea of making ephemeral and process-oriented work that cannot be absorbed so easily by the market still exists within the academy. Dada, lettrism, and the Situationist International, land art, arte povera, Fluxus, and conceptualism have all been artistic movements that, at least at first, couldn't easily be swallowed by the art market and its consumers. New art will undoubtedly offer new possibilities of resistance, while the equal challenge remains to find ways in which what is useful about market thinking can be incorporated into art education and artistic practice. And while the market's influence is in the ascent now, this is a perishable fruit—just as it has previously been the case that art historians, critics, and curators have each taken their turns as influencers. We have seen the same situation within the academy as it took up theoretical positions on colonialism and postcolonialism, gender, and class. They have all been great engines of debate and then have been pulled into the curriculum and disappeared through the back door of esteem, smelling too much of (necessary) political correctness, of doing good rather than thinking freely and widening our perspectives.

Is it still possible to believe, as the political theorist Antonio Gramsci did, in the artist as an organic intellectual whose role is not to act subordinate but to be

a critically independent voice that negotiates civil society? In some ways. But it is most important to not fall into the trap of considering any of the art world's players or institutions as fixed entities. This constant flux, this shift of what outside and inside even are, makes it possible to open up a space in education for rethinking values and judgements and to develop new critical practices. The biggest challenge may not be the pressure of the art market, but the willingness of the academy to challenge itself.

1 This essay does not address the curricula of BA, MA, or MFA degrees, nor is it a reflection on art education per se. Instead, it is my comment on recent developments that affect artistic education. The original version of this text was written for the conference *A Certain MA-ness*, organised by Henk Slager for the Utrecht Graduate School of Visual Art and Design, in collaboration with the Sint-Lukas Brussels University College of Art and Design, in Amsterdam, on March 8, 2008. Additionally, it addresses a panel debate and workshop, "A New Institutionalism? A Look at the Public Dimension of the Private Art School," organised by Mary Jane Jacob at the School of the Art Institute of Chicago on February 24, 2007.

2 Alex Farquharson, "Bureaux de change," *Frieze*, September 2006, <https://www.frieze.com/article/bureaux-de-change>.

Thinking about Thinking Together

23

Anders Kreuger

2011

This is an amended version of a text that was first published in *Teaching Art in the Neoliberal Realm*, ed. Pascal Gielen and Paul De Bruyne (Amsterdam: Valiz, 2011). Reprinted by permission of the publisher and author.

The invitation to write about art teaching made me think, which is almost invariably a good thing. I have some thirty-five years of work experience, much of it related to pedagogy in some sense, if only because I have always, in all the roles I have assumed, had to address other people in a clear, lively, and thought-provoking way. I have had many opportunities to reflect on the pros and cons of what is commonly referred to as “communication” and “mediation.” These activities are problematic, I find, because they too often use language in predictable and flattening ways and therefore suspend the curiosity and unfettered thinking they were supposed to promote. But here I will look more specifically at my experience of teaching and what it might teach us.

Since the mid-1980s I have made my living in the following fields, in roughly chronological order: language teaching at university level; art mediation in a conservative art museum; translating and interpreting in a foreign policy environment; cultural diplomacy and arts administration for an international organisation; freelance curating of small and large contemporary art exhibitions; freelance writing about art and related topics for catalogues and journals; freelance lecturing, moderating, and translating and book editing in a contemporary art environment; academic research on curating; teaching curatorial practice and art theory; institutional curating in a *kunsthalle*; academic administration; teaching fine art studio practice; institutional curating

in a medium-sized contemporary art museum; directing a small private *kunsthalle*.

My trajectory is not an unbroken line of ascent or descent, nor is it a haphazard zigzag. At least that is how it looks to me now. It all started with a strong interest in art, language, and history, which made me study art history, political science, comparative linguistics, and modern languages (Lithuanian, Russian, and Finnish) at Stockholm University. I have travelled in different directions with this luggage, and I have been able to convert all my objects of study into action and results in the different chapters of my professional biography. So many of my curator colleagues have similarly speckled backgrounds that I rarely have to defend or even explain mine. One of the greatest attractions of working in contemporary art, I have always thought, is that it accommodates such a great variety of interests. More than most other fields, contemporary art allows for a generalist approach. At the same time, of course, the art world is a highly specialised context. This balancing between the open and the closed also has implications for teaching art.

Teaching

The first time I was asked to teach I was still a student. For two years, I had been the only student of my unusual subject. Lithuanian is a notoriously difficult language, and because of my two teachers' almost total lack of interest in the process

and protocol of learning, I had to find my own way through a thicket of obtusely formulated grammatical rules, which had to be extrapolated from hard-to-find books. How inspiring, how *emancipating*, to be left to one's own devices like that! This was my first encounter with non-pedagogy after twelve years of well-intended but overly pedagogical schooling.¹

Some other people wanted to start with Lithuanian in September 1986, and I was put in charge of them, since no one else could or wanted to do the job. I was already a convert to the non-method of "theoretical" philological study, as opposed to the drip-feeding of "practical" knowledge that was, and still is, the pedagogical norm for learning a new language. I decided that going through the textbook chapter by chapter was fine, but only after I had given my students an outline of the basic construction of Lithuanian and its meaning in a global linguistic perspective. This sounds ambitious, and it was, but my seemingly counterintuitive undertaking to base the first month of teaching entirely on my own hand-drawn illustrative plates of the language's deep structure proved reasonably successful. The usefulness of these posters strengthened my resolve to treat theory as the foundation for practice, rather than vice versa. They also showed me that almost anything could be visualised without oversimplification, which was a good reminder of the need for precision in teaching.

After doing things more or less directly related to politics for more than ten years, I found myself teaching again in the early 2000s. I had just assumed a new identity, that of the freelance curator, and besides getting my first commissions for exhibitions and essays, I was getting invitations to give occasional lectures in Scandinavian art academies. As a matter of both principle and convenience, I would speak only on subjects that intrigued me at the time. This simple rule is, I have found, also true of institutional programming: do not try to guess what interests other people; try instead to share your own interests with them. I lectured, for instance, on the topic of “contemporary bureaucracy as art” at Malmö Art Academy, on “the unfinished sentence” at the Royal University College of Art in Stockholm, and on Walter Benjamin’s phrase “to read what was never written” at the Finnish Academy of Fine Arts in Helsinki.² Obviously, preparing for such lectures helped me to shape and deepen my own reading practice and curatorial research.

The next stage in my development as a teacher was when I was invited by some of the same academies as well as others, like the Royal Academy of Fine Art in Copenhagen and the Trondheim Academy of Fine Art, to give week-long seminars. I developed yet another non-pedagogical method (or perhaps it was a pedagogical non-method): reading original texts aloud to students, with frequent

breaks for explanation and commentary, rather than offering “applied” versions of Walter Benjamin, Gilles Deleuze, Hannah Arendt, Martin Heidegger, Sigmund Freud, and Henri Bergson (these were the authors I focused on in 2002–07).

I am not ranting, but simply stating a fact, when I note that young people’s reading skills have changed since the mid-1980s, when I was a student. It is partly to do with a general decline in teaching arts and letters at school, but more significantly with the institutionalisation of the short attention span due to clickable hypertext and real-time online feedback. Urbane, intelligent art students know better than to lose time with books when they are alone in the studio or at home, where they cannot immediately weave their newfound knowledge into a social web involving their peers, a figure of authority, and the collectively sustained sense of possible future gain. This is unsurprising. Like most people today, art students need to feel secure that what they are doing is important, and preferably all the time. They have been taught that knowledge is useless unless you can use it. Curiosity for curiosity’s sake is something many of them have “unlearned” (a too fashionable word, but appropriate in this context).

The reading seminar without homework is one way of addressing this contemporary psychological reality. First, an adapted rendering of the concept of time as duration, or the idea that the past is preserved in the past, can never substitute the

sheer intellectual shock and aesthetic pleasure that Bergson's concise and unpredictable verbal images offer us when we read them or listen to someone reading them to us. Second, the collective reading of *The Life of the Mind, What Is Called Thinking?*, or *The Logic of Sensation* becomes a performance.³ This is recognisable as an art format and therefore more pleasurable—and important—than an individual act of reading, which is associated with everything art students are supposed to be less good at: wrestling with language, following a thread from beginning to end ... Finally, the possibility to monitor whether the seminar participants actually understand the text is a crucial element of this pedagogical experiment. Explanatory digressions are an efficient tool if they are precise and well timed.

Students of curating have an even shorter attention span than fine art students. At least that is what conventional wisdom tells us. They are even more focused on the instant gratification of converting knowledge into networking benefits or concrete results. Of course, there are different kinds of curating students and different kinds of study programmes. The MA in Curating Contemporary Art at the Royal College of Art (RCA) in London, where I taught in 2003–04, was at the time known for not neglecting the technical and social skills of exhibition making. I was called in to supervise a group of twelve graduating students as they were collectively putting together an exhibition and a documentary

film programme, so I appreciated that they had been trained in the fundamentals of making things happen. I continued in the same fashion, giving small workshops on topics such as how to write letters to commercial galleries and how to edit an artist's CV, and I supervised the students as they renovated the rundown gallery spaces of the RCA. This methodology of learning by doing was, I thought, a suitable way to share my experience of being a curator.

None of these four teaching roles—conveying synthesised insight into a complex system, formatting specific aspects of discourse into lectures, performing text for a small collective, and supervising a classic apprenticeship—was uncomplicated. They all required experimental approaches and solutions. Yet they were directly related to my own expertise as a philologist, writer, and exhibition curator. My latest “proper” teaching job, as Visiting External Lecturer at Malmö Art Academy in 2010–11, was by far the most difficult and the most worthy of thought. How could I, as an active curator and writer and former administrator (I had been Director of this academy in 2007–10) use my own experience in the one-to-one studio conversation with a student who is becoming a practising visual artist? I, who do not define myself as an artist? What were my advantages in this predicament? My disadvantages?

Every studio visit is a delicate and sensitive situation. Work is

underway, and the teacher is invited (always invited by the student, never inviting himself) to respond to it and to help steer the ongoing process. I decided to stay true to my non-pedagogical approach, making it clear to the students that I would always respond very directly to whatever they showed me, without censoring my impulse to verbalise what I saw or trying to make it fit into any "learning strategy." But before I say more about my experience of studio teaching, I will allow myself a few digressions.

Curating

First some very basic reflections. Having worked in a few different capacities, I have developed some attitudes that I think are suitable for all kinds of work. I always try to do things that are a little bit too difficult for me, to avoid getting bored and to make sure I keep learning new things. I have discovered, sometimes the hard way, that it may be good to put your own "personality" (which of course is forever changing and developing) into your work, but that it is bad to take your work personally. Getting angry with others, or really feeling sorry when you apologise for your mistakes, is rather unhelpful. And perhaps most pertinently: the result of your own work will always, if you are lucky, become material for someone else. It means that we should not be offended when others cannibalise our thoughts and misquote us for their own purposes. All these bits of self-help wisdom

can be quite important to remember when you are teaching.

My question to myself is: How I can best use my experiences as a curator in the studio visit situation? To answer it, I need to clarify, and at the same time complicate, how I view my profession. This is also known as "problematizing" (another sadly overused word). There are different approaches to curating, and curators usually subscribe to several of those in their practice. As we have seen, curating may be regarded as a technique or a set of skills that can be taught and learned: the things you need to know to make good exhibitions or be an efficient "art mediator" in other ways.⁴ Alternatively, it can be described as an attitude or awareness of quality or mark of cultural sophistication, which is more difficult to acquire through training. Such contemporary and highly specialised connoisseurship is, I sometimes suspect, the actual connotation of "the curatorial," a recent coinage in the growing literature on curating.

Curating is in fact increasingly recognised as a mode of operation reflecting what drives contemporary capitalism: the "art of choosing."⁵ In an economy no longer characterised by scarcity and need, knowing how to select from an abundance of offerings is what creates visibility and status. The *good choice* is perhaps the only act that consumerist society accepts as meaningful and "personal." Seen in this light, the curator's role as an arbiter of taste (a taste that aims to transcend the merely aesthetic and embrace the psycho-

logical, the social, and the political) is perfectly designed for a networked world that privileges the relational over the substantial and reference over interpretation.

It is healthy to remind ourselves of another possible understanding of curating: as a mode of thinking that cannot function if it is too far removed from the practice of animating objects and ideas (making them come alive in three-dimensional and social space) or if it excludes the other (the object, the author, the viewer) from its operations. This, in fact, is how the failure of exhibitions can often be explained: that the curator decided to do all the thinking himself, disregarding interesting things that did not fit with his "concept." At the same time, practitioners of curating must have enough confidence in its methods and goals to avoid reducing it to mediation. Rather than assuming the role of the go-between, the curator should aim to produce situations where people can *think together*.

This was my tentative conclusion when I sat down to scrutinise curating some years ago, after being invited to submit a proposal for a biennial. I even entitled my exhibition outline "Thinking Together." The starting point was a rather straightforward understanding of the phrase: that an exhibition is an event designed to bring people together to *think* rather than to "do something." The "think tank" is sometimes brought up as a model for both exhibition making and academic research in visual art, with the motivation that a group of

like-minded curators or doctoral candidates working informally together will challenge each other's assumptions and deliver more innovative results. Yet this analogy, inspiring as it is, will mislead us if we ignore the actual purpose and functioning of established think tanks. More often than not, these are ideologically and commercially motivated purveyors of partisan views for the political marketplace. We may want to play a curatorial game with the overtones of kitsch enthusiasm that resonate in "thinking together,"⁶ but do we really want contemporary art to make itself useful as a lobbying instrument?

When I thought more about these two words, I remembered another way to connect and interpret them. They may point us in a direction that is less ambitious than a gathering of minds but perhaps more pregnant with meaning for the practice (and theory) of curating. People can think together, but *things* can also be *thought together*. In contemporary academia, the latter interpretation of thinking-together (the hyphen is optional) is gradually winning acceptance as an experimental methodology for combining various forms of knowledge into new speculative ensembles.⁷ This allows academic writers to look for unexpected similarities or analogies between seemingly disparate phenomena, which could be seen as a return to the foundational moment of comparative science (linguistics, archaeology, anthropology) in the late eighteenth and early nineteenth centuries. The thinking-together of

different thoughts is the equivalent of a comparison that deserves to be made even if we do not know what knowledge it might produce.

The common practice of thinking-together is therefore no less ambitious than the utopian ideal of thinking together. The two can also be combined. I once failed in an interesting way when I wanted to do precisely this at an informal gathering, in Oslo, of artists and theoreticians. What I tried was to put an array of inspirations and interpretations “on the table,” so that my listeners might combine them into new constellations. I wanted them to do this “together,” which is never a self-evident activity. Together with me? Together as a group? It is difficult either way, and might not even work. In a sense, the Oslo talk was a perfect illustration of the core difficulties of this proposition. Although I enhanced my lack of coherence with performative awkwardness, the presentation remained too open-ended, too scattered. Yet I believe that “Thinking Together” (my still unrealised exhibition plan) reveals a hidden need that should be made explicit and converted into concrete curatorial and pedagogical work.

True to my non-method for teaching theory, I read out short passages from original texts that had helped me to configure a *semantic field* for my idea—a fuzzy set of meanings presenting a multidimensional mental image rather than a concise verbal definition.⁸ The most important of these sources are Gilles Deleuze’s elusive notion of

the “noosign,” or “thinking image”;⁹ Jacques Rancière’s no less ambiguous parsing of the “pensive image”;¹⁰ and, above all, Pierre Teilhard de Chardin’s overtly speculative but more accessible description of the “noosphere,” a “sphere of thought” postulated in analogy with the biosphere, or “sphere of life.”¹¹ I find all of them very relevant for thinking about curating and, in the context of this essay, for thinking about teaching.

It is perhaps paradoxical that I, who think of myself as an only moderately social person, should insist on speaking in such terms of “togetherness” and on trying to grasp what unites the connection of people with the connection of ideas. I do tend to avoid togetherness whenever I can, and particularly larger groups of people, but on the other hand I am also not interested in going it alone and thereby imposing my own attitudes on others. At least for now, before I have had time to over-elaborate my idea, I find it meaningful to identify curating as a mode of thinking that will not thrive in splendid and dictatorial isolation. It is this vision of the curator’s role that I tried to carry over into my parallel activities as an art teacher.

Teaching Art as a Curator

Teaching studio practice to young aspiring artists offers a minimal model for thinking together: the meeting of two individuals within the format of the educational studio visit. Yet it must be acknowledged that this is

an abstract and idealised view of the institutional reality that constitutes life in the art academy. The two individuals are under different kinds of pressure: one being weighed down with the task of turning the other into a student, the other saddled with the task of becoming an artist by using himself and others as material.

On the one hand, there are good reasons why teachers should not fraternise with students. The effects on the microcosmic world of the academy might be devastating if things get too personal between the two categories. Intergenerational affairs are, as we all know, not unheard of, but I side with those who condemn them while the teacher-student relationship is still in place. While I was at Malmö Art Academy, I even decided to not accept any offers of Facebook friendship (a common ritual for expressing satisfaction with a lecture or a studio visit, and not a very personal act at all) until the counterpart had graduated from the Academy. On the other hand, Rancière's observation that the teaching situation produces ignorance in order to perpetuate itself is relevant also in the ostensibly democratic contemporary art academy.¹² The potentially emancipating educational studio visit is embedded in a hierarchical order that threatens to compromise it. It is always difficult to make thinking-together work when the parties to the situation are unequal.

So there are some difficulties with the institutional framework and psychological realities of teaching

fine art. Presumably, similar problems occur across the whole educational sector, but what makes the art academy particularly challenging is that it offers comparatively little curriculum-based education and instead focuses on students' individual processes of becoming-artist under the supervision of older and more accomplished colleagues. Such continuous personalised tutoring is the most important component of a degree in fine arts. Usually this is an affair between artists. Only those who are themselves practising (and successful) artists are entrusted with looking at, understanding, and responding to the work that is emerging in the studios.

But surely there are also ways of making curators' knowledge useful to fine art students? First of all, curators must know how to put their experience of art into words. This is what "mediation" is all about. Good curators should be able to write concise and expressive prose, which is one way of converting functional mediation into something more creative and challenging. A clear and precise verbal response to students' work is important for the quality of the studio visit. Curators must also be good at gathering information, creating associative links across vast stretches of data and, crucially, retaining names and dates and other details that make communication more accurate and efficient. One important task for fine art teachers is to make students aware of the context of their work, to show them what has already been done: how,

why, by whom, where, and when. I have often used the internet as a reference tool during studio visits, but for this I must be able to recall names and feed them into the search engine. I dare say that curators, in general, are better at this than artists. Name-dropping is simply part of the curatorial *déformation professionnelle*.

Finally, curators must always pay attention to the pragmatic details that can enhance art making, if students learn to master them. Thinking ahead about possible solutions for presentation is one way to trouble-shoot an idea. Both artists and curators are skilled in this, but curators have the advantage of having worked with different artists who have different needs. They are trained to see things from both inside and outside the individual artist's perspective. Curators participate in the production of art but are also detached from it. In my experience, one of the best questions to ask art students is: "How would you yourself react if you were confronted with this work in an exhibition?" This serves as an introduction to discussing the need for some basic clarity in the structure of a work. Art students are quite often anxious about showing work that is "too obvious." While "communication" may not be the purpose of art making (at least, I don't think it is), communication often contributes to the success or failure of a presentation. Curators who teach fine art should be uncompromising in their emphasis on critical seeing, but they should also unambiguously stress

the importance of using language as a tool.

When I was Director of Malmö Art Academy, I initiated a one-week workshop to address this issue of language and writing in relation to studio practice. I invited my experienced colleague Helena Holmberg, curator at Index in Stockholm, to teach it together with me. We decided to call the workshop "Curating for Artists" and to focus on the notion of the "art project" (with its deliberately "logistical" overtones) and to coach students in three different ways to use text: as part of a work (a vehicle for self-expression), in a project description (to attract interest and possible support for a project in the making), and in a press release (to advertise a finished project). We wanted the students to grasp the meaning and basic method of the "functional" writing that curators have to master, believing that practising artists would also benefit from such skills.¹³

The workshop was part of the obligatory course package for second-year BFA students, along with a course in basic accounting and tax and copyright law and a workshop in grant application writing. Feedback from the participants was overwhelmingly positive (all courses at the Academy are evaluated in writing by the students), but after half a year or so I was already hearing complaints from faculty members. The students had, I heard, become too complacent about developing their studio practice and planning their BFA graduation essays,

thinking that this had already been taken care of in the project descriptions Helena and I made them write for the workshop. The curatorial approach to “projects,” I also heard, was derailing the more insecure students who were struggling to develop their actual work. The gist of the critique against “Curating for Artists” was that it is unsuitable to teach the “too instrumental” curatorial approach to language when the process of becoming-artist is still in such a delicate stage.

I accepted these objections as credible, because I knew that transferring the curator-artist relationship to the teaching situation would always be problematic and difficult, and as a result of discussions with faculty, the workshop was suspended. Yet in retrospect I believe that the risks were overstated, and that Helena and I were making a valid point with “Curating for Artists.” The mission of Malmö Art Academy, as I formulated it, was threefold: to educate new artists, to provide proper employment for accomplished artists, and to produce new knowledge. I maintain that new artists need to know not only how to produce work but also how to situate their work in the world at large so that it can be received as new knowledge. Now that I have withdrawn from the Academy and from teaching and instead meet younger artists in my capacity as a museum and *kunsthalle* curator, I am strengthened in my conviction that success comes to those who have both sets of skills.

The main problem of the art academy, as I see it from my different vantage points, is that it too often becomes a power base in itself, serving the interests of those who operate within the academic system rather than the students or even the teachers. Too much of what the academy does to renew itself and be future oriented is actually to do with securing funding. This is, as far as I understand, true of the doctoral research programmes as well as of the international exchange projects, the special publishing projects, the high-flying seminars with invited guest speakers ... All this is fine and well, as long as the everyday routine of studio visits and technical and theoretical courses (these were the basic teaching formats at Malmö Art Academy) are not allowed to fall into neglect. I am convinced that the art academy has the potential to be a site for the production of something new and for thinking-together in the two senses I have tried to elaborate.

Therefore I resent it becoming a machine that turns potential partners for innovation into “students” or, even worse, into the “pupils” of the pre-Bologna tradition. I resent becoming authoritarian in my role as a teacher, which is partly a result of pressure from “the system” and partly a tendency in my own personality that I have to resist. To strike the right balance between the professional and the personal is, I think, the challenge that makes teaching continuously interesting.

Nevertheless, the reason I stopped teaching is simple: I no longer have enough time for it. When you are fully dedicated to institutional curating, everything you do should be geared towards creating a maximum of art world visibility for your institution and for yourself. Sadly, teaching does not do that; it is too long term and low key to register as a curatorial achievement. In this sense "the system" takes care to preserve a traditional division of labour between artists and curators. Teaching studio practice is a good career move for artists and less so for curators. Yet I hope that I will have the opportunity, in the not-too-distant future, to take up this kind of teaching again, and to push it further into the territory of curating so that the studio visit really becomes an arena for thinking-together.

1 I have often thought of my encounter with the Department of Baltic and Slavic Languages at Stockholm University as a somewhat uncanny parallel to the interview, in the cellar of the university, with Dr. Uzzi-Tuzii, professor of Bothno-Ugrian languages, in Italo Calvino's *If on a Winter's Night a Traveler* (on pages 51–58 in my copy of the Swedish translation by Viveca Melander, *Om en vinternatt en resande* (Stockholm: Bonniers, 1983)). After all, a three-week course in Old Prussian grammar and text fragments was part of the MA degree I earned in 1990 ...

2 This is an important phrase in Walter Benjamin's 1933 essay "On the Mimetic Faculty." See Walter Benjamin, "On the Mimetic Faculty," in *One-Way Street*, trans. Edmund Jephcott and Kingsley Shorter (London: Verso, 1979), 162.

3 Hannah Arendt, *The Life of the Mind* (San Diego: Harcourt, 1971); Martin Heidegger, *What Is Called Thinking?*, trans. J. Glenn Gray (New York: Perennial, 1976); Gilles Deleuze, *Francis Bacon: The Logic of Sensation*, trans. Daniel W. Smith (London: Continuum, 2003).

4 When this essay was first published, in 2011, I was employed by M HKA—Museum of Contemporary Art Antwerp, as a "presentation specialist." My colleagues from Romania tell me that a museum curator there is officially a *muzeograf*.

5 See Dorothea von Hantelmann, "The Curatorial Paradigm," *Exhibitionist*, no. 4 (2011): 8.

6 By way of example, I will just mention William Isaacs's book *Dialogue and the Art of Thinking Together: A Pioneering Approach to Communicating in Business and in Life* (New York: Bantam and Dell, 1999), and the working congress on the "municipal transition system" organised by the city of Cologne on June 3–4, 2008, under the title *Zusammen denken, gemeinsam handeln* (Thinking together, acting as one).

7 See, for example, Gordon G. Globus, *Quantum Closures and Disclosures: Thinking-Together Postphenomenology and Quantum Brain Dynamics* (Amsterdam: John Benjamins, 2003). Quantum brain dynamics in itself is a fine example of thinking-together. It was launched in the late 1960s when the Japanese physicist Hiroomi Umezawa first used quantum field theory to try and explain the sub-neuronal functioning of the human brain, and it has produced the intriguing theory that memory relies on non-localisable macroscopic quantum operations involving the quasi-crystalline behaviour of the brain's water molecules.

8 On this topic one of the best writers is Vasily Nalimov, a dissident Soviet philosopher of science whose grandfather was a Komi shaman: "Thus, if human consciousness operates with fuzzy, probabilistically weighted sets of concepts, is it possible to introduce this system of concepts directly into our language? The experience of statisticians, representatives of the subjective probability interpretation, shows that it is extremely difficult, if at all possible, to extract from people prior, probabilistically given ideas of some familiar phenomenon. Though such fuzzy knowledge almost certainly exists, people for some reason or other will not, or perhaps cannot, transfer it to others. This barrier is erected by our culture: it is not customary to reveal the process of thinking; hence, communication goes on at the discrete level." Vasily Nalimov, *Realms of the Unconscious: The Enchanted Frontier*, trans. A.V. Yarkho (Philadelphia: ISI Press, 1982), 16.

9 Here is an important but typically nonexhaustive quote from Deleuze: “The image had to free itself from sensory-motor links; it had to stop being action-image in order to become a pure optical, sound (and tactile) image. But the latter was not enough: it had to enter into relation with yet other forces, so that it could itself escape from a world of clichés. It had to open up to powerful and direct revelations, those of the time-image, of the readable image and the thinking image.” Gilles Deleuze, *Cinema 2: The Time-Image*, trans. Hugh Tomlinson and Robert Galeta (London: Athlone, 1989), 23.

10 “I have tried to impart some content to the notion of pensiveness that refers to something in the image which resists thought—the thought of the person who has produced it and of the person who seeks to identify it. By exploring some forms of this resistance, I have sought to show that it is not a constitutive property of the nature of certain images, but a set of distances between several image functions present on the same surface.” Jacques Rancière, “The Pensive Image,” in *The Emancipated Spectator*, trans. Gregory Elliott (London: Verso, 2011), 131.

11 “I am first of all dreaming of the extraordinary network of radiophonic and televisual communication which, in anticipation perhaps of a direct tuning-together of brains through the as yet mysterious forces of telepathy, is already connecting us, at this very moment, in a kind of ‘etherised’ common consciousness.” And another quote: “It is clear that research, yesterday still a luxury occupation, is now becoming the primary, and even principle, function of humanity. —What does this great event tell us? I, for my part, can see only one explanation. It is that the enormous excess of free energy, released by the establishment of the Noosphere, is naturally, as a matter of evolution, destined to pass into the construction and functioning of what I have called its ‘brain.’ In this the Noosphere is similar to the organisms that preceded it. Humanity is progressively becoming ‘brainier.’ In order to fill what is called our leisure time, we must therefore devote it to new work of a higher nature. This is a biological necessity, and it leads to a general and collective effort of vision. The Noosphere is an immense thinking machine.” Pierre Teilhard de Chardin, “La Formation de la Noosphère: Une interprétation biologique plausible de l’histoire humaine” (1947), in *L’Avenir de l’homme* (Paris: Editions du Seuil, 1959), 190 and 195. My translation.

12 “To explain something to someone is first of all to prove that he cannot understand it by himself. Before being the act of the pedagogue, the explanation is the myth of pedagogy, the parable of a world divided into learned spirits and ignorant spirits, mature and immature spirits, capable and incapable, intelligent and stupid.” Jacques Rancière, *Le Maître ignorant : Cinq leçons sur l’émancipation intellectuelle* (Paris: Fayard, 1987), 15–16. My translation.

13 This is how we introduced the workshop to prospective participants: “Introduction to the project format: delimitating and developing a project; different stages of carrying out a project; different kinds of texts for presenting and marketing a project: project descriptions, texts being part of a project, press releases.” Course description for “Curating for Artists,” Malmö Art Academy, spring semester 2009.

Andrea Geyer

2007

This text is based on a lecture delivered for the conference *What Kind of Art Academy Would Women create?*, Iceland Academy of Arts, Reykjavik, October 2005. First published in the *Malmö Art Academy Yearbook 2006–2007*. Republished by permission of the author.

“One is like so many that one is not one, never one, always one of a number. One is one of many but not the same as any other, never the same, not exactly. One is peculiar, be both one thing and another, here and there, real and imaginary. Certainly one terminates. Everyone has an end. One falls everywhere, resting anywhere but one never keeps the same in the same place like the others. One simply does not have a choice. Rising one falls and collects. Dropping to gather, one changes, and one evaporates, and each one is constrained by the same gravity as any other.”

—Gregg Bordowitz¹

After I was invited to develop this essay for a lecture at the Iceland Academy of Arts in Reykjavik in 2005 in the context of the symposium *What Kind of Art Academy Would Women Create?*, I could not help but think about Leontine Sagan’s *Mädchen in Uniform* (1931). It is a filmic saga about a Prussian boarding school run with discipline and order where only one of the all-female staff—the beautiful Fräulein von Bernburg—shows

some heart, thus causing the main character, a fourteen-year-old girl, to fall in love with her. That thought of course made me smile, as I know that this was not that scenario that I was invited to address in the context of the conference. But my thought was in fact revealing to me a need to examine some of the propositions made by the title of this conference. I will obviously, and I admit deliberately, put aside the symposium’s founding motivations for now. I will

get back to the palpable and also subtle discriminations in regard to gender in institutions that teach art, and even more so in the field of art (the art world at large) in a little while.

For now, I will take a little detour, following some of the foundational questions that come along with the discussions of “women’s rights” and “feminism.” Of course I will only be able to touch on some, and even on those only lightly, within the frame of this paper. Nevertheless, what I will try to suggest is that it is these rather foundational questions that offer a productive space in the midst of an expansive debate. This is true specifically in the face of the institutional celebration of feminism currently occurring in 2007, which seems to encourage a canonisation of a rather heterogeneous discourse. Why try to build a canon instead of creating the space that these debates actually still need—or should I say, will inevitably need again and again.²

What Kind of Art Academy Would Women Create? This title implies that if an exclusive group of people specified as “woman” came together to create an alternate (oppositional?) system of education, the changes—or better, the shift in education—brought about by them would lie exclusively in the very identity of these actors as “woman.” It is this assertion—literally unfolded as such—that I have

difficulty in following, even in the hypothetical. Actually, I have to resist it. Not to claim a polemical opposition, but to actually move through what problems these assertions point to and why I will use them to start detours to what I personally think is at stake in terms of gender and education today, especially within the field of art.

Any Act Should Assume Unified Terms to Get Started; or, What Happens When I Say “Woman” in a Classroom Today?

Growing up in the 1970s with feminism already established as an “institution,” I was too young to be part of the identity politics of the early 1980s. I recognised the drive and the usefulness of the term and the identity of “woman” at that time. Yet I myself had found an understanding of gender (and therefore myself) in the discursive space of the late 1980s and early 1990s with different ideas on these categories, informed on the one side by Judith Butler’s *Gender Trouble* (1990) and on the other by the challenging questions asked towards language by Monique Wittig in the *Straight Mind* (1992) and Denise Riley in *Am I That Name?* (1988). Of course, I was also living and working within an environment that had significantly changed since the first-wave feminist struggles of the 1970s (and of course partly due to those struggles). I was confronting my gender identity

as a contested site of identification in dialogue with being a recent settler to the United States and a white person in the American context of the Clinton era. So instead of embracing a pre-scripted, even if politicised, identity that the generation before me had carved out, I needed to locate the path towards my right to be who I am. This struggle was at the same time deeply personal and also generational and intersectional, grounded in the present moment in which I was coming to terms with it. This personal experience points to the inevitable when I teach yet another generation of students: the students I work with at Malmö Art Academy and in the United States today need to reconcile and form their identity differently than I did. That means I have to be conscious and acknowledge the paths that my students are making in terms of their struggle for identity rights happening within yet another political environment —one that I am of course also continuously responding to, but did not form my identity in relation to. I also recognise that they are making those paths now with the newly named and demarcated gender identities available to them. I understand the identities they attach themselves to, as well as those they create, as contextual, and never merely descriptive. It is through this understanding of the mobility of these identities that I recognise the impossibility and

limits of language and terminology in the face of such complexities. But taking this into account not as a limit, but as a possibility, allows me to productively raise issues around discrimination based on gender in the present moment, for my students and for myself.

The students and I in our respective multitudes of gendered beings together create and enact a community that has to be in its difference (not unity). It is from this place of community across difference that we can understand and discuss the formation of their identities as well as the oppression some experience based on their gender. Put simply: we need to acknowledge the fact that the students' conception of who they are in terms of gender is not necessarily that of the teachers, even if similar terminology is used. This is a process that needs to take its own generational and personal time, and it does not concur with lesson plans. What I have recognised is that, within feminism, each generation has to realise and locate its own particular place and need of struggle in terms of its identities. And only after that generation locates its path and the conditions that form it will some of that generation be compelled to relate themselves to larger histories of feminism—never before.

In acknowledging these different and shifting identities (including my own), the question for me has been: How do I work with those

differing identities without slipping into relativism but rather find a thread, an alliance, and a form of organisation that relates, and therefore creates, a discussion across difference (without a desire to unify) that can challenge the dominant order without reinscribing reversed stereotypes or yet another form of hierarchy? For example, when using “woman” with students, I have to unfold the term, historically and ideologically. The term, in its abstraction, is standing in for concepts in relation to different traditions of thoughts and different contextual interpolations.

The word “woman” doesn’t necessarily address every woman, female, queer, lesbian, trans man, or, more often than not, myself. This demonstrates that a system of language that describes the divided subject (man/woman) ontologically is not very useful and cannot be folded successfully into the identities at stake in the political struggles with which we are engaged today.³ To add to that is the fact that “woman” historically has shown itself to be a term that excludes. Working myself through these thoughts, it becomes clear that the point to start and work with when addressing discrimination based on gender in the classroom today is to ask: Who are the individuals that are patronised and discriminated against within the inevitably patriarchal environment we work in? And I do that without naming

them with any specific term. Then, from this place of experience and observation—of being present to where I stand, to who my students are today, to who faculty and staff is—I can start to identify structures within the institutional context that frames us that I would like to challenge, resist, rewrite, and overcome. And I can start working collectively with those affected on how to do that work.

What’s Your Problem?; or, Don’t We Live in a Post-feminist Area?

I am very aware of and subjected to the discrimination that exists within the arts, within education, and beyond. This field of arts is fundamentally structured along intersecting axes of gender, race, sexuality, class, ability, nationality, and age, to manifest different privileges and power. Starting from the recognition of individual art practice, visibility as a practising artist, and value, these discriminations affect the majority of practitioners, including professors, adjunct faculty, staff, and students at many art academies. This discrimination is a bleak fact, a tangible part of my professional life as an artist. But nevertheless, I find when addressing this fact in the classroom, it is treated by significant number of today’s students as an urban legend. Because they assume that they are simply accepted as who they are. That structures of power offer a choice to participate or not. These

students experience themselves to be above this kind of discrimination. They believe that this privileged position is theirs because of their own individual excellence, as artists who will and can exceed the confinement of conventional labelling. They don't recognise (yet) that this position is a sign of their inherent privilege, which, if unreflected upon, sustains such discrimination.

Discrimination based on race or gender can be a challenging issue to address in the classroom. It is messy, it triggers defensiveness, and in the art context it is often conflated with claims or dismissal of quality. When this topic is addressed by a female-appearing professor, it can be read and disregarded as an older woman's "bitterness" and "defensiveness," caused by a personal lack of success. Another turn-off is that, once put forward as a condition or problem, there is not "a" solution: there is no simple list of things to do differently, and you also cannot escape it. Discrimination based on gender and race is a prevailing condition intertwined with other forms of discriminations. Maybe because of the above as a topic and as an actual practice, even among fellow artists feminism has become highly unfashionable to address or engage. Part of this also stems from the limitations of second-wave feminism when it comes to gender nonconforming identities and the lack of consideration of the intersections of gender, ability,

socioeconomic power, and race. There seems to be no end to sexism in any case, and a confrontation with curators or gallerists or colleagues along its lines brings too much discomfort all around and so is considered not worth it—a nuisance—hitting closed minds.

For the occasion of this lecture, I went out and did a little bit of fieldwork. I asked a group of fifteen students that I work with at Malmö Art Academy, in Sweden, what they thought needed to be challenged around gender within education. Their answers did not surprise me. There was strong resistance to the term "feminism," as it seemed to most of them to be a term that is historical and not useful today, because the female students did not feel discriminated against. See above. They believe that they are judged just and only on the quality of their work. Feminism, they said, simply prescribes for them to be victims and for others to be the predators, no matter how much the male students themselves felt bothered by the mainstream "macho" attitudes and values. Their spontaneous response to feminism was that it feminism in itself was discriminating against them. In one way or another, they all articulated that was actually feminism that was constantly reinscribing a divide, and that that was not their experience. Feminism was keeping them hostage in stereotypes they felt utterly uncomfortable with. Another interesting outcome

of this conversation was that there was a definite resistance from all students to the suggestion that they are in any way, consciously or unconsciously, complicit in any form of it.

What I observed though, when asking them about their experiences in the art world, their lives at the academy, and their personal lives, is that they were experiencing discrimination continuously. But because of their self-positioning as beyond sexism, and their consequent rejection of feminism as a political and social necessity, they lacked the language and tools to address the discrimination that they seemed to experience nevertheless. Their liberation from and rejection of the terms of feminism, I noted, left them at this point inarticulate in the face of their struggles, and therefore having trouble organising collectively against those sexism.

Given my conversation with my students, I have to ask: How can I work with terms like “feminism,” often already considered as an ideology or institution itself, one unaware of its own edges and limits? What does it take in this environment to put the actual drive (may I say passion) of feminism — the fight against discrimination based on gender — into action? How can I teach and expand this struggle into its intersections with race, ability, and socioeconomic standing as a necessity? What is the role of language in this needed

pedagogy? How can I support the students (independent of their gender) to be prepared for the highly gendered and segregated environment of the art world if they resist acknowledging these conditions? And, on a broader level: How can one respond to the challenges of the never-ending sexism without falling oneself into roles that are already written and immobile, and therefore reinscribing instead of deconstructing gender hierarchies?

What Privilege Isn't; or, Unlearning One's Privilege as One's Loss

With these challenges from the inside and the outside, I find it helpful to look at feminist literary theorist Gayatri Chakravorty Spivak's notion of “unlearning one's privilege as one's loss.” Literary scholars Donna Landry and Gerald MacLean put Spivak's thinking this way: “Our privileges, whatever they may be in terms of race, class, nationality, gender, and the like, may have prevented us from gaining a certain kind of Other knowledge: not simply information that we have not yet received, but the knowledge that we are not equipped to understand by reason of our social position.”⁴ Spivak suggests that, in coming to see one's privilege, one may see how one is limited and shaped by a particular view or discourse, and also realise that other ontologies and epistemologies exist and, in fact, compete against

one's own. The idea of "unlearning one's privilege as one's loss" marks a metaperspective on the hierarchies of modern society, since it may be interpreted as a question. To address gender discrimination on the basis of privilege offers an entry into the debate that bypasses morality and a simple notion of political correctness by classifying discrimination as a lack of knowledge, a blind spot, a lack—a loss, in fact. And this opening towards knowledge releases the deadlock of prescribed bipolarities and offers a broader perspective on the question of how questions of gender operate within systems of power.

Following Spivak's example, in a very broad sense, the task is to guide students to the limitations of their positions within the patriarchal system, and how these limitations not only apply to them but also affect others, all students (and all teachers) alike. The aim is to arrive at discrimination as a collective problem through a critical reflection on beliefs, prejudices, and assumptions of norms and their formation as naturalised in one's own perception. These reflections can also take into account that, within a political struggle, identities such as woman, trans, queen, man, queer, female, lesbian, gay, and any nuance in between do not have to be fixed and determined to have credibility and agency, but rather should be considered potent, not despite, but because of, their respective fluidity. They

can be understood as an agile and responsive strategy, in response to a universal condition. Thus, what gender means, how it is performed and experienced, both individually and structurally, can be acknowledged as constantly under negotiation and therefore also not restrained.

As a consequence, I suggest that the need to unify concepts of identity within traditional feminist debate should be replaced by a building of alliances along lines of equity and recognition and considerations that run across acknowledged and celebrated difference based on the multiple possibilities of intersectional identities. I believe that what is needed today for a productive feminist struggle is not simply the collective validation of any one "oppressed identity" but instead a collective validation of and commitment to difference. We must support our students in this process of recognising each other as different, recognising each other's gender identities in dialogue with other markers such as culture and race. We should affirm each other's right to and the beauty of self-determination, and give assurance to our students that this affirmation of difference does not need to lead to individualisation, fragmentation, and maybe consequentially isolation—but, on the contrary, that organising across lines of affinities is an incredibly powerful tool in any political struggle.

What I describe here is of course a longer process in need of repetition. The choreographer and filmmaker Yvonne Rainer said once that all we can ever be is “recovering sexists, racists, classists, etc.” I’ve always appreciated this comment, as it liberated me from the conception of an ideal reality that should be reached as an ultimate goal—something like an ultimate enlightened condition. It allowed me to instead see the goal in the process itself: to create an ongoing awareness of discrimination around oneself but also importantly within one’s own perception. The aim is to include the modes of challenge within one’s practice, not as a burden but as a fact and as a potential. I see this establishment of a space of continuous negotiation being most productive in a teaching environment. To quote Spivak once more:

“An uncoercive rearrangement of desires, then; the repeated effort in the classroom.”⁵

After giving the term “woman” some consideration, I would like to return to the institution and its structures and suggest a new set of questions: What kind of institutions do we need that do not reinscribe the hierarchical violence of patriarchy? What structural changes need to be made within institutions to not reinscribe discrimination and sexism? How can we foster the already existing forms of intersectional feminist organisation within art institutions?

Liberal Feminism or Anarchist Feminism

Given my little example from the celluloid world in the beginning, Sagan’s *Mädchen in Uniform*, we know that institutions or environments exclusively run by women are not necessarily feminist spaces. One could say that feminism is a structure, a process, a form of organisation that is driven by values and ideas of gender equality and also by the need for a response towards the oppression of patriarchy. Kara Stern’s 2005 doctoral thesis, “Chased by Fate? A Life History of Sheila Sadler and the Founding of the Village Community School,”⁶ offers an interesting investigation into several community schools in New York City founded and led by women over the last thirty years. The study analyses the different leadership strategies and the effect they had on the community of the school and the school’s graduates. Following the sociologist Kathleen Iannello’s examination of feminism and organisational theory, Stern points to a differentiation among two branches of feminism, the first of which is “liberal feminism,” described as the equal rights work that took place during the 1970s and ’80s aimed at “reducing or eliminating patriarchy from larger governing institutions.”⁷ This definition of feminism still resonates in most minds when confronted with the term today, and it often prompts resistance. The second

branch is “anarchist feminism,” which as a movement focuses on organisational theory and the “development of structures that avoid the kind of coercive power transmitted through hierarchical organization.”⁸ It is this second term that I find interesting for us to investigate when thinking of possible structural changes. What Iannello is suggesting is an organisation built around empowerment rather than power. For her, *power* represents domination and is typically wielded in hierarchical organisations, whereas *empowerment* is a characteristic of non-hierarchical institutions and represents the ability to actually accomplish something and offers space for growing into and recognising one’s abilities. Iannello concludes that this form of organisation is aimed at building institutions that foster a shared sense of ownership and that turn teachers, administrators, and students into team, members, and stakeholders, with the aim to create an environment in which the members form connections between and among one another—connections that are based on mutual trust, an agreed set of rights and values, and a collective caring for the institution. It is these elements that challenge discrimination at its core, as all members are active participants within the institution and actively create and are responsible for the atmosphere within. Iannello

describes these elements as the seal of a feminist approach to institutional organisation.

I can see the challenges that such a radical reorganisation of institutions would ask for, but I think it is worthwhile to consider some of the suggestions and carry their values into a practice of teaching. With the classroom, we can work with forms of organisation that tend to the building of teams and members of a learning collective in which teachers are one part, aware of discriminatory microstructures and equipped to collectively tackle them one by one, if they occur. To foster these dialectical structures within the academies, and to mark their value and necessity, is to create a supportive space for collectivity that the students can carry on and use in their professional lives. And as an artist, I know how much that is needed in the field. Even though this suggestion to work collectively and through empowerment in terms of building critical forms of organisation seems relatively simple, trying to realise it while teaching within the highly individualised art world, which has a strong echo in art academies, is quite challenge and a real task. As bell hooks states:

Feminist education—the feminist classroom—is and should be a place where there is a sense of struggle, where there is visible acknowledgment of the union of theory and

practice, where we work together as teachers and students to overcome the estrangement and alienation that have become so much the norm in the contemporary university. Most importantly, feminist pedagogy should engage students in a learning process that makes the world “more rather than less real.” In my classrooms, we work to dispel the notion that our experience is not a “real world” experience. This is especially easy since gender is such a pressing issue in contemporary life. Every aspect of popular culture alerts us to the reality that folks are thinking about gender in both reactionary and progressive ways. What is important is that they are thinking critically. And it is this space that allows for the possibility of feminist intervention, whether it be

in our classroom or in the life of students outside the classroom.⁹

To conclude, I would like to answer the call of the conference that prompted this text—“What kind of art academy would women create?”—in a direct way. I agree with Kara Stern’s suggestions that the potential in a feminist institution lies not exclusively in the identities that enable it or the values that it teaches, but first of all in the mode of its organisation. And that it is through these forms of organisation that we should steer away from exclusions based on limiting notions of identity. On the contrary, exceeding what we imagine when we say “women” or “men,” we should organise into structures that can sustain complex and differing identities and their continuous fluidity, and embrace that radical potential.

- 1 Gregg Bordowitz, "More or Less," *LTRR*, September
2005.
- 2 A phenomenon that deserves attention in itself,
but unfortunately I will not be able to address it in the context of
this paper. See, for example, *WACK! Art and the Feminist Revolution*,
exhibition, Geffen Contemporary at MOCA, Los Angeles, March 4–July
16, 2007; *Global Feminisms*, exhibition, Brooklyn Museum, March
23–July 1, 2007; *The Feminist Future: Theory and Practice in the
Visual Arts*, symposium, Museum of Modern Art, New York, January
26–27, 2007.
- 3 Denise Riley, *Am I That Name?: Feminism and
the Category of Women in History*, reprint edition (Minneapolis:
University of Minnesota Press, 2003).
- 4 Donna Landry and Gerald MacLean, "Introduction: Reading
Spivak," in *The Spivak Reader*, by Gayatri Chakravorty Spivak, ed.
Donna Landry and Gerald Maclean (New York: Routledge, 1995), 4–5.
- 5 Gayatri Chakravorty Spivak, "Terror: A Speech after 9-11,"
in *boundary 2* 31, no. 2 (May 2004): 82.
- 6 Kara Stern, "Chased by Fate? A Life History of
Sheila Sadler and the Founding of the Village Community School"
(PhD diss., New York University, 2005), [https://search.proquest.com/
docview/305466347](https://search.proquest.com/docview/305466347).
- 7 Kathleen Iannello, *Decisions without Hierarchy:
Feminist Interventions in Organization Theory and Practice* (New York:
Routledge, 1992), 39.
- 8 Iannello, quoted in Stern, "Chased by Fate?"
- 9 bell hooks, "Toward a Revolutionary Feminist
Pedagogy," in *Talking Back: Thinking Feminist, Thinking Black*
(Boston, MA: South End, 1989), 49.

My involvement with Malmö Art Academy started in 2012, when a group of students was assigned to a project I was realising at dOCUMENTA (13) in Kassel, Germany. *27 Gnosis* was an absurdist, linguistic game show led by artist Kira Nova and I, set within a massive mud mound. From atop a lilac spherical stage, participants were directed through a series of confounding world-building exercises derived from the interplay of a set of twenty-seven “gnoses”: nose-like sculptural forms, each representing a different concept. Students performed various roles within the production, which ran throughout the summer, helping to induce onlookers into what, from the outside, must have resembled a strange cult. We were suited in black clothing with expertly tailored gashes cut in the back and legs, and we all reeked of the same perfume, designed specifically for the occasion to loosen people’s tongues (although the German production crew told us it was giving them headaches!). Kira and I spent many days with the students in what amounted to a crash course in language, logic manipulation, and behavioural dance, all inextricably bound, as it often is in theatre, with play and laughter. There was a lovely sensation of leaving the mud mound and feeling you’d had a riotous time with your most imaginative friends, and I think this was in large part

due to the camaraderie that developed with the Malmö team. Wanting to extend our microcosm after *documenta*, we invited the students to come join us in Vilnius to help realise some projects for the Baltic Triennial, which Kira and I were curating. We thought it would be a real long shot for Gertrud Sandqvist, as the Academy's Rector, to sign off on the idea, but she happily agreed. I've kept in touch with many of those students since.

This permissiveness and trust in artists' knowledge and experimentation is what distinguishes Malmö Art Academy from so many other pedagogical institutions I've been involved with. Looking at the course offerings each year, I'm continually impressed by the ever changing combination of rigorous academic and theoretical foundations with forays into unexpected, esoteric fields and artist-led projects. This is not only a testament to Gertrud Sandqvist's inexhaustible intellect and wide-ranging curiosity but also to the incorporation of the evolving interests of the teachers and students in the school's curriculum.

Over the years, the Art Academy has allowed me great latitude to explore artistic research with the students on everything from performance methodologies and choreography to experimental comedy, folk taxonomies, and the design of participatory environments. My particular approach is to further learning through embodied experience in a process of mutual invention, risk, and generative confusion, of which joy is an essential ingredient.

The last course I taught, "An Undeniable Hit" in February 2020, was one of my favourites. The idea was to arrange a first-time collaboration between students from Malmö Art Academy and Malmö Theatre Academy on the ridiculous quest to create together, in only three weeks, an "undeniable hit performance," which was to

be presented within the black box theatre in the Mazetti building. The following questions were the starting point for our explorations: What makes a “hit” in the rarefied worlds we operate in? What is it like to focus on relatability, universality, joy, urgency, affect, generosity, hope, catchiness, electricity, caring for the audience? Does a hit need to be only a 5 percent deviation from existing art—that is, can the public only take so much originality? Do we need to lobotomise ourselves to create a hit? Must we sell our souls?

After brainstorming about the tropes and features of contemporary performance in the realm of both theatre and the visual arts, we started to generate lots of raw material—songs, texts, and movement fragments—through various improvisatory methods. We tried to honour the truth of these unfiltered impulses that sprout from the body, lungs, and mouth without undue interference from the intellect. We then shaped these bits, permuting and developing them, and enhancing peculiarities that stimulated us. The next step was to assemble the refined bits into sequences, and only then to start making sense of the themes and concepts that were emerging so that they could inform the evolution of the piece as a whole.

It was interesting to see how the different cultures and working methods of the Theatre and Art Academies interacted. The students from the theatre school were used to spending most of their days together in rehearsal rooms and were envious of the solitude the arts students had in their studios. Conversely, the arts students appreciated the collaborative spirit in the theatre school and the access to large spaces with technical infrastructure to develop performances. In the visual arts, we are used to putting a premium on concept and criticality and often spend little

time considering the experience of the audience—underpinned by the misconception that entertainment can't also be critical. Whereas in the theatre, one always must have the audience in mind, experience is the name of the game, and “entertainment” is not a dirty word.

I saw my role in this production as overseer, rather than as director. It was important to involve the students in every step of the development of the piece—choreography, text, dramaturgy, costumes, lighting, music—working in the fashion of devised theatre companies, although at a hyper-accelerated pace. We often used laughter as a litmus test of whether our embodied abstractions were working, whether the elements were churning and colliding like radioactive isotopes. What we ended up with was a dance theatre show that started as a dark, ominous medieval epic about the subjugation of the peasantry, then mutated into a competition between some very fashionable purple frogs, next swerving into a wistful sleepover, a boy band concert, group techno-aerobics, a lament about the loss of identity, a strangely moving and unironic dance in the dark with faces lit by mobile phones, and finished up with a rousing singalong finale about self-actualisation. I'm not sure if it was an “undeniable hit,” but after only three weeks of work we definitely had a compelling show on our hands that juggled many contemporary forms and ideas and seemed to activate the audience in all the right ways. This kind of hybrid production, driven by collective joy among the troupe, can only arise within an institution that nurtures experimentation, elasticity, and cross-fertilisation.

Images pp. 334–335:

For the first time ever, a joint course, “An Undeniable Hit/ En oslagbar föreställning,” was held for students at both Malmö Art Academy and Malmö Theatre Academy. The course leader and teacher, Michael Portnoy, worked together with nine students from the Art Academy and the Theatre Academy in Studio B of the Mazetti Building during the period January 28–February 14, 2020.

Participating students: from Malmö Art Academy—Tringa Gashi, Elísabet Anna Kristjánsdóttir, Ivan Nylander, Elísabet Birta Sveinsdóttir and Filip Vest; from Malmö Theatre Academy—Eira Fröjdh, Theodor Ryan, Miriam Röstlinger Goldkuhl and Emily Willman. Image courtesy of Michael Portnoy and Sophie Ljungblom

Image pp. 336–337:

Michael Portnoy, *27 Gnosis*, 2012. Installation and performance, dOCUMENTA (13), Kassel, Germany. Image courtesy of Henrik Strömberg









Julie Ault

Julie Ault (US) earned a PhD at Malmö Art Academy in 2011 with her doctoral project *Remembering and Forgetting in the Archive: Instituting "Group Material" (1979–1996)*.

Ault is an artist, curator, and writer whose work encompasses the fields of exploratory research, exhibition making, and publishing. Ault often adopts curatorial and editorial modes as creative practice. Her recent work includes the exhibition *Nancy Spero: Paper Mirror* at Museo Tamayo, Mexico City, and MoMA PS1, Long Island City, NY (2018–19), and writings on Wang Bing, Allora & Calzadilla, and David Wojnarowicz. Ault's edited and authored publications include *In Part, Writings by Julie Ault* (2017), *Tell It to My Heart* (2016), *Nancy Spero: Codex Artaud* (2015), *Two Cabins by JB* (2011), *Show and Tell: A Chronicle of Group Material* (2010), and *Come Alive! The Spirited Art of Sister Corita* (2006). In 1979, Ault cofounded the New York-based collective Group Material (active until 1996). Ault is currently a MacArthur Fellow.

Ute Meta Bauer

Ute Meta Bauer (DE) was Guest Teacher for the MFA in Critical & Pedagogical Studies at Malmö Art Academy between 2000 and 2004.

Bauer is a curator. Since 2013, she has been Founding Director of NTU Centre for Contemporary Art Singapore and Professor in the School of Art, Design and Media

at Nanyang Technological University, Singapore. Prior to this, she served as Dean of Fine Art at the Royal College of Art, London (2012–13) and was Associate Professor at the School of Architecture and Planning at the Massachusetts Institute of Technology, Cambridge, MA (2005–12), where she was also Founding Director of the Program in Art, Culture, and Technology and Director of the MIT Visual Arts Program. For ten years, she was Professor and Head of the Institute for Contemporary Art and Head of the Institute of Cultural Studies of the Academy of Fine Arts Vienna (1996–2006).

As a curator, Bauer served as Artistic Director of the 3rd Berlin Biennale for Contemporary Art (2004) and was Co-curator of *documenta11*, Kassel, Germany. In 2015, she, with Paul C. Ha, co-curated the United States Pavilion at the 56th Venice Biennale, featuring the eminent artist Joan Jonas.

Bauer has edited numerous publications in the field of contemporary art and art education, including *Education, Information, Entertainment: New Approaches in Higher Artistic Education* (2001), *Intellectual Birdhouse: Artistic Practice as Research* (2012), and *AR—Artistic Research* (2013).

Ola Billgren

Ola Billgren (1940–2001, SE) visited Malmö Art Academy as Guest Lecturer in 1996.

Billgren was a Swedish artist. He worked in various mediums, but painting was

central to his practice. He experimented with painting throughout his life, was self-taught, and became one of Sweden's most recognised artists during his lifetime. Billgren also worked as a writer and critic.

His art can be found in various public collections in Sweden including County Museum of Gävleborg, Gothenburg Museum of Art, Malmö Art Museum, Norrköping Art Museum, and Moderna Museet in Stockholm, as well as abroad at Louisiana Museum of Modern Art in Denmark and Musée National d'art Moderne Centre Georges Pompidou in Paris.

Jürgen Bock

Jürgen Bock (DE) has been Guest Teacher at Malmö Art Academy since 2004 and was also External Examiner in 2004 and 2017. Since 2019, Bock has been a PhD candidate at Malmö Art Academy and Lund University.

Bock is a curator, writer, and producer based in Lisbon. Curated exhibitions include CCB Project Room, Centro Cultural de Belém, Lisbon, 2000–01; Triennale-India, New Delhi, 2005; Portuguese Pavilion, 52nd Venice Biennale, 2007; Museo Nacional Centro de Arte Reina Sofía, Madrid, 2012; La Criée, Rennes, France, 2012, and Johann Jacobs Museum, Zurich, 2014.

Over the course of the last twenty-six years, Bock has established and grown the Maumaus School of Visual Arts, an internationally

recognised independent study programme in Lisbon. Since 2009, Bock has curated and programmed more than forty solo exhibitions at Lumiar Cité, the exhibition space affiliated with Maumaus.

In addition, he has written numerous essays, published a range of catalogues, and edited several books, including *From Work to Text: Dialogues on Practise and Criticism in Contemporary Art* (2002). He has produced several artist books, including Renée Green's *Negotiations in the Contact Zone* (2003). Bock has been responsible for the organisation of a range of international conferences and has produced several documentary films, such as *Negritude: A Dialogue between Soyinka and Senghor* (2015) and *An Opera of the World* (2017), both directed by Manthia Diawara.

Sebastião Borges

Sebastião Borges (PT) graduated with an MFA from Malmö Art Academy in 2018.

Borges is an artist based in Lisbon. Previous to attending the Academy, he also studied at Maumaus Independent Study Programme, Lisbon, in 2015–16, and holds a BA in Sculpture from Faculdade de Belas-Artes Universidade de Lisboa, from 2014. Recent exhibitions include COSMOS, P h l o r y s t a, and Oriental do Desterro, all in Lisbon; Galleri Arnstedt, Östra Karup, Sweden; Malmö Konstmuseum; and Fondazione

Antonio Ratti, Como, Italy. Borges has received awards from Fundação Calouste Gulbenkian—Apoio a Novos Criadores em Cinema (2020), E & H Bergmans / Munthe Sandberg (2018), and Fundação Calouste Gulbenkian (2016–18). Borges is currently producing and directing his first feature film.

Lynne Cooke

Lynne Cooke (AU) visited Malmö Art Academy as Guest Lecturer in 1998 and 2004 and as External Examiner in 2000.

Since 2014, Cooke has been Senior Curator, Special Projects in Modern Art, at the National Gallery of Art in Washington, DC. Prior to that, Cooke held the positions of Chief Curator and Deputy Director at the Museo Nacional Centro de Arte Reina Sofía, Madrid, from 2008 to 2012, and Curator at Dia Art Foundation, New York, from 1991 to 2008. In 2012–14, she was Andrew W. Mellon Professor at the Center for Advanced Studies in Visual Arts, Washington, DC. Among the many exhibitions she has curated over more than three decades are *Outliers and American Vanguard Art*, National Gallery of Art, Washington, DC, 2018; *Rosemarie Trockel: Cosmos*, New Museum, New York, 2012; 1996 Biennale of Sydney; 1991 Carnegie International (with Mark Francis), Pittsburgh; and solo shows of Zoe Leonard, Dorit Margreiter, Alighiero Boetti, Agnes Martin, Bridget Riley, Richard Serra, and

Francis Alÿs. In addition, Cooke has published widely on contemporary art.

Övül Ö. Durmusoglu

Övül Ö. Durmusoglu (TU) graduated from the Critical Studies Post-graduate programme at Malmö Art Academy in 2006.

Durmusoglu is a curator, writer, and educator living in Berlin. As a curator, she acts between exhibition making and public programming, singular languages and collective energies, worldly immersions and political cosmologies. She recently co-initiated the project *Die Balkone: Life, Art, Pandemic and Proximity* in Berlin with Joanna Warsza. Her other recent curatorial project, *Stars Are Closer and Clouds Are Nutritious under Golden Trees* took place at the MMAG Foundation, Amman, in 2019.

Previously Durmusoglu was Curator at steirischer herbst festival, Graz; Curator/Director for the YAMA public screen, Istanbul; Curatorial Adviser for Gülsün Karamustafa's *Chronographia*, Hamburger Bahnhof; and Artistic Director of the 2013 Sofia Contemporary festival in Bulgaria, titled *Near, Closer, Together: Exercises for a Common Ground*. She curated programmes for the 10th, 13th, and 14th Istanbul Biennials and coordinated and organised different programmes and events at Maybe Education and Public Programs for DOCUMENTA (13) in Kassel, Germany. She is Co-curator of the 3rd Autostrada Biennial in

Prizren, Kosovo, with Joanna Warsza, which will take place in the summer of 2021.

Durmusoglu is Guest Professor at the Graduate School of the Berlin University of the Arts and a Visiting Professor at the Hochschule für Bildende Kunst Braunschweig, Germany.

Okwui Enwezor

Okwui Enwezor (1963–2019, NI) visited Malmö Art Academy as Guest Lecturer in 2004.

Enwezor was a curator, art critic, editor, and writer. In 1987, he earned a BA in Political Sciences at New Jersey City University. In 1994, Enwezor launched *Nka Journal of Contemporary African Art*, together with Chika Okeke-Agulu and Salah M. Hassan. He also held the position of Associate Curator at the International Center of Photography in New York.

Enwezor's wide-ranging practice spans the world of international exhibitions, museums, academia, and publishing. He served as Director at Haus der Kunst, Munich (2011–18) and Dean of Academic Affairs and Senior Vice-President at San Francisco Art Institute (2005–09). He was Global Distinguished Professor in the Department of Art History, New York University (2013) and Kirk Varnedoe Visiting Professor at the Institute of Fine Arts, New York University (2012).

Enwezor was Artistic Director of Documenta11, Kassel, Germany; 2nd Seville Biennial, Spain; 7th Gwangju Biennale, South Korea;

and 56th International Art Exhibition, Venice Biennale, among others. He furthermore curated numerous exhibitions and authored and edited many publications.

Andrea Geyer

Andrea Geyer (DE/US) was Professor of Fine Arts at Malmö Art Academy between 2001 and 2009.

Geyer is an artist based in New York whose work ranges across multiple mediums, incorporating text, photography, painting, sculpture, video, and performance. It explores the complex politics of time and memory, with a particular focus on those who identify or at some point were identified as woman. In her work, she finds ways to re-materialise the entanglement of presence and absence created by ideologically driven omissions in archives and histories through a process of performatively un-sensing time. From her early investigations into urban environments, cultural landscapes, and notions of citizenship and nationhood in the US as well as her native Germany to more recent research into women's contributions to modernism, Geyer's work continuously seeks to create spaces that offer reorientation(s) of the past towards the urgency of a present moment.

Geyer's work has been exhibited widely at institutions including the San Francisco Museum of Modern Art; Museum of Modern Art, Whitney Museum of American Art,

Artists Space, and White Columns, all in New York; Contemporary Art Museum Houston; A Space Gallery, Toronto; KINDL—Centre for Contemporary Art, Berlin; Stedelijk Museum Amsterdam; Irish Museum of Modern Art, Dublin; REDCAT and LACE, Los Angeles; Tate Modern and Serpentine Gallery, London; Kunstmuseum St. Gallen, Switzerland; Göteborgs Konsthall; Generali Foundation and Secession, Vienna; Museum der Moderne Salzburg; Govett-Brewster Art Gallery, New Plymouth, New Zealand; Turin Biennale; São Paulo Biennial; and documenta 12, Kassel, Germany.

International public collections with Geyer's work include the Museum of Modern Art, New York; Whitney Museum of American Art, New York; San Francisco Museum of Modern Art; Colección Jumex, Mexico City; Neue Galerie, MHK, Kassel, Germany; Museum der Moderne Salzburg; and Federal Collection of Germany. She is represented by Hales Gallery, New York, and Galerie Thomas Zander, Cologne. Geyer is Associate Professor at Parsons Fine Arts, the New School.

Karin Hald

Karin Hald (DK) holds an MFA from Malmö Art Academy from 2015 and is currently enrolled in the Master's programme in Artistic Research at Malmö Art Academy.

Hald also earned an MFA in Literary Composition from HDK-Valand Academy

of Art and Design, Gothenburg, in 2018. In 2015, Hald cofounded Forlaget Gestus (Gesture Press), where she has acted as Curator and Editor. Forlaget Gestus works with artists who equate language with text and writing. The result is exhibitions where an artist book is made alongside the show and both elements are given equal weight. Hald herself works as both a writer and an artist, and she is interested in radical empathy and subversive strategies seen in the light of posthumanism and spirituality.

Maj Hasager

Maj Hasager (DK) is Vice Rector and Senior Lecturer in Fine Arts at Malmö Art Academy.

Hasager studied photography and fine art in Denmark, Sweden, and the UK. Her artistic approach is research based, dialogical, and interdisciplinary, and she works predominantly with text, sound, video, and photography

Hasager has exhibited her work internationally in events and at institutions such as Lunds konsthall; Fondazione Pastificio Cerere, Rome; Critical Distance, Toronto; GL STRAND, Copenhagen; Galleri Image, Aarhus, Denmark; FOKUS video art festival, Nikolaj Kunsthal, Copenhagen; Moderna Museet, Malmö; Cleveland Institute of Art; Red Barn Gallery, Belfast; Laznia Centre for Contemporary Art, Gdańsk; Liverpool Biennial; Al-Hoash Gallery,

Jerusalem; Al-Kahf Gallery, Bethlehem; Khalil Sakakini Cultural Center, Ramallah; Overgaden Institute of Contemporary Art, Copenhagen; and Guangzhou Triennial.

Hasager is the recipient of several international residencies and fellowships, most recently at 18th Street Arts Center, Los Angeles. She has been awarded grants in support of her work from Edstrandska, Danish Arts Council, Danish Arts Foundation, Arab Fund for Arts and Culture (Beirut), and ArtSchool Palestine.

Additionally, Hasager is a guest lecturer at the International Academy of Art Palestine; Dar al-Kalima University College of Arts and Culture, Bethlehem; Barbados Community College, Bridgetown; Sacramento State University; and University of Ulster, Belfast. She occasionally writes essays, catalogue texts, and articles.

Leif Holmstrand

Leif Holmstrand (SE) was educated at Malmö Art Academy from 1997 to 2002, and then joined the school's Post-graduate programme in Critical Studies in 2002–03.

Holmstrand is a non-straight writer, musician, and artist whose work has been shown in Vladivostok, Seoul, Tokyo, etc. His approach is ritualistic and expansive, rooted in harsh bodily experiences and a psychedelic view on materials and techniques.

Olav Christopher Jenssen

Olav Christopher Jenssen (NO) was External Visiting Lecturer in Fine Arts at Malmö Art Academy between 1995 and 2010.

Jenssen is an artist based in Berlin and Lya, Sweden. His production encompasses drawing, watercolour, painting, graphic work, book illustration, and books. Simultaneously working with multiple series and mediums, Jenssen alternates between the different works mentally and physically—from informal and rapidly painted pictures to more strict and formal paintings, in monumental as well as intimate formats. Always exploring and adopting new methods and techniques, his works contain both continuity and diversity.

Over the years, Jenssen has produced several public commissions ranging from murals and wall reliefs to free-standing monumental sculptures. He was appointed professor at Hochschule für Bildende Künste, Hamburg, in 1996, and since 2007 has held a professorship at Hochschule für Bildende Künste, Braunschweig. He is represented in many public collections, including the Museum of Modern Art, New York; Moderna Museet, Stockholm; Astrup Fearnley Museum of Modern Art, Oslo; Centre Pompidou, Paris; Kunstmuseum Bonn, Germany; Kiasma Museum of Contemporary Art, Helsinki; Preussischer Kulturbesitz, Berlin; Marta Herford, Germany; and National

Museum of Art, Architecture and Design, Oslo.

Jenssen has had major exhibitions at the Astrup Fearnley Museum, Kiasma, and Kunstsmuseum Bonn. Recent exhibitions include *Enigma*, Marta Herford, 2012–13; *Journal—Works on Paper, 1979–2012*, Henie Onstad Kunstsenter, Høvikodden, Norway, 2013; *Olav Christopher Jenssen*, Saarlandmuseum, Saarbrücken, Germany, 2014; and *Estragon*, Sprengel Museum, Hanover, 2018. In 2019, he had his most recent museum exhibition at the Astrup Fearnley Museum, an impressive display of all his works in the museum's collection.

Mary Kelly

Mary Kelly (US) has been a frequent Guest Teacher at Malmö Art Academy and an important source of inspiration for the MFA programme. In 2017, Kelly was awarded an honorary doctorate by Lund University.

Kelly is a legendary artist known for large-scale narrative installations that address questions of sexuality, identity, and historical memory from a feminist perspective. Her solo exhibitions include surveys at Moderna Museet, Stockholm; Whitworth Art Gallery, Manchester; and Centre for Contemporary Art, Warsaw, as well as representation in major group shows including the Whitney Biennial, Biennale of Sydney, and documenta 12, Kassel, Germany. She received a Guggenheim Fellowship in 2015.

Kelly was Director of Studios at the Independent Study Program, Whitney Museum of American Art, New York, from 1989 to 1996, and from 1996 to 2017, she was Distinguished Professor at the School of the Arts and Architecture, University of California, Los Angeles, where she founded the Interdisciplinary Studio Area. Currently, she is Judge Widney Professor, Roski School of Art and Design, University of Southern California.

Mark Kremer

Mark Kremer (NL) visited Malmö Art Academy as Guest Lecturer in 1997.

Kremer is a curator and art writer based in Amsterdam. In 2019, the Mondriaan Fund awarded him a grant to follow the development of artist Christiaan Bastiaans's *Valuable Cargo* (2019), a video installation and live performance in Takamatsu, Japan. Curated exhibitions include *When Elephants Come Marching In: Echoes from the Sixties in Today's Art*, De Appel, Amsterdam (2014–15), a show that tracked and staged encounters between psychedelia and conceptualism in the current art landscape.

Anders Kreuger

Between 2007 and 2010, Anders Kreuger (SE) was Head of Department and Director at Malmö Art Academy.

Kreuger is a curator, writer, and educator. Since 2019, he has been Director of Kohta, a private *kunsthalle*

in Helsinki. Previous to that, he was Senior Curator at M HKA, Museum of Contemporary Art Antwerp (2011–19) and Exhibitions Curator at Lunds konsthall and a member of the programming team for the European Kunsthalle in Cologne (2007–11). In the late 1990s, he directed NIFCA—Nordic Institute for Contemporary Art and the Nordic Arts Centre in Suomenlinna, outside Helsinki, and before that the Nordic Council of Ministers' Information Office in Vilnius.

Kreuger contributes to *Kunstskritikk* and was, from 2012 to 2018, a frequent contributor to the London-based art journal *Afterall* and a member of its editorial team. He has authored numerous catalogue essays and edited numerous books. Furthermore, Kreuger has taught at the Royal College of Art, London; Trondheim Academy of Fine Art; Higher Institute for Fine Arts, Ghent; Salzburg International Summer Academy of Fine Arts; Estonian Academy of Arts, Tallinn; Vilnius Academy of Arts; Academy of Fine Art, Oslo; and University of Bergen.

Ellinor Lager

Ellinor Lager (SE) holds an MFA from Malmö Art Academy from 2018 and is currently enrolled in the Master's programme in Artistic Research at Malmö Art Academy with her research project *Placenta Parenthesis*.

In *Placenta Parenthesis*, she negotiates the “experience of becoming, expansions and descents.” This research revolves around the structures and language of the female body in relation to birth and pregnancy. Lager is an artist working mainly with sculpture and text, and she has exhibited in Sweden at Gallery Arnstedt, Östra Kaarup, and Köttinspektionen, Uppsala, and she is represented in the collection of the Malmö Art Museum.

Matts Leiderstam

Matts Leiderstam (SE) was Professor of Fine Arts at Malmö Art Academy in 1997–2001 and 2011–18 and is currently External Visiting Lecturer in Fine Arts and a Researcher at the Art Academy.

Leiderstam is a visual artist who seeks out stories connected to the act of painting, and most of his works can be described as growing out of a very simple question: What does a painting do? His works are often made “after” older practices, in conversation with art history, its materials, and its circulation—investigations that frequently lead him into museum storage and archives. Leiderstam is currently working on a research project, with support from the Swedish Research Council. He obtained a PhD in Fine Arts at Malmö Art Academy in 2006 and studied painting at Valand Academy, Gothenburg, in 1984–89.

Selected solo presentations from the last decade include Andréhn-Schiptjenko, Stockholm, 2018; Wilfried Lentz, Rotterdam, 2017; Collectors Space, Istanbul, 2016; and Kunsthalle Düsseldorf and Grazer Kunstverien, 2010. Selected group shows include Art Encounters Biennial, Timișoara, Romania, 2019; 11th Shanghai Biennale, 2016; *Generosity: The Art of Giving*, National Gallery, Prague, 2016; *Recto Verso*, Fondazione Prada, Milan, 2015–16; *In Search of Matisse*, Henie Onstad Kunstsenter, Høvikodden, Norway, 2015; 8th Berlin Biennale, 2014; and *Ciclorama*, Museo Tamayo Arte Contemporáneo, Mexico City, 2013.

Sarat Maharaj

Sarat Maharaj (ZA/UK) is Professor of Visual Art and Knowledge Systems and Supervisor of the Doctoral Programme at Malmö Art Academy.

Maharaj is a writer and curator. He has curated a large number of exhibitions, and among others he co-curated documenta11 in Kassel, Germany, and the Guangzhou Triennial in 2008. He curated a show at Museum Boijmans Van Beuningen, Rotterdam, with Richard Hamilton and Ecke Bonk, in 2002, and co-curated a show for the 29th Bienal de São Paulo. Maharaj was furthermore Chief Curator of the 2011 Göteborg International Biennial for Contemporary Art, and Peer Adviser to the Sharjah Biennial 11 in 2013.

Maharaj was Professor of History and Theory of Art at Goldsmiths, London (1980–2005); the first Rudolf Arnheim Professor, Humboldt University, Berlin (2001–02); Research Fellow at the Jan Van Eyck Akademie, Maastricht (1999–2001); and Visiting Fellow at RKD—Netherlands Institute for Art History, Stedelijk Museum Amsterdam, and University of Amsterdam (2018).

His research and publications focus on Marcel Duchamp, James Joyce, and Richard Hamilton, and his writing covers: Monkey-doodle—“thinking through art practice,” visual art as know-how and no-how, textiles, xeno-sonics and xeno-epistemics—“thinking the other and other ways of thinking,” cultural translation, “dirty cosmopolitanism,” North/South divisions of work, manufacture, and “creative labour.”

Stephan Møller

Stephan Møller (DK) graduated from Malmö Art Academy's MFA programme in 2019 and was Guest Teacher at the Academy in 2019 and 2020.

His projects often wind up involving a complex of text, images, and objects, though lately he has been working increasingly with sculpture. Among his recent exhibition are *FLUX*, Skissernas Museum, Lund, 2019, and *SCOTOMA*, KHM1 Gallery, Malmö, 2019. In the autumn of 2020, Møller will participate in group exhibitions at Galleri Arnstedt, Östra Karup,

Sweden, and at Den Frie Centre of Contemporary Art, Copenhagen.

Lars Nilsson

Lars Nilsson (SE) was Professor of Fine Arts at Malmö Art Academy from 1995 to 2005.

Nilsson is an artist based in Stockholm whose practice includes painting, sculpture, and video, as well as installation. His solo exhibitions include Galleri Andersson/Sandström, Stockholm; VIDA Museum and Konsthall, Halltorp, Sweden; Instituto Tomie Ohtake, São Paulo; Eskilstuna konstmuseum, Sweden; Milliken Gallery, Stockholm; Schloss Agathenburg, Hamburg; Moderna Museet, Stockholm; National Gallery of Denmark, Copenhagen; Palais de Tokyo, Paris; Magasin III, Stockholm; Stockholm Konsthall; and Victoria Miro Gallery, London. Recent group exhibitions include Artipelag, Hålludden, Sweden; Bienal de Curitiba, Brazil; Gothenburg Museum of Art; Sundsvall Art Museum, Sweden; Karlskrona Konsthall, Sweden; Nationalmuseum, Stockholm; Moderna Museet, Stockholm; and Kunsthall Charlottenborg, Copenhagen.

Since 2015, Nilsson has been a member of the board of the Royal Swedish Academy of Fine Arts, Stockholm.

Max Ockborn

Max Ockborn (SE) graduated with an MFA in 2012 and an MFA in Critical & Pedagogical Studies in 2017, both from Malmö Art Academy.

Ockborn is an artist based in Malmö. Previous to attending the Academy, he also studied in the Maumaus Independent Study Program, Lisbon, in 2011. Recent solo exhibitions include Galerie Leger and Galleri Krets in Malmö and Studi di Cultural Documents in Filignano, Italy. Recent group exhibitions include Fullersta Gård, Huddinge, Sweden; Alta Artspace, Malmö; Södertälje Konsthall, Sweden; Bonniers Konsthall, Stockholm; 卍, St. Gallen, Switzerland; and Galleri Nicolai Wallner, Copenhagen. Ockborn is cofounder of the exhibition and project space Celsius Projects in Malmö.

Joana Pereira

Joana Pereira (PT) graduated from the MFA programme at Malmö Art Academy in 2018 and Maumaus Independent Study Program in Lisbon in 2013.

Pereira is an artist based in Malmö. Recent exhibitions include Lunds konsthall; Arnstedt Gallery, Östra Kaarup, Sweden; CC Galleri CC, Malmö; and Celsius Projects, Malmö. She participated in the Cité Internationale des Arts Residency, Paris, in 2019.

Michael Portnoy

Michael Portnoy (US) has been Guest Teacher at Malmö Art Academy since 2013.

Portnoy is a New York-based artist. Coming from a background in dance and stand-up comedy, his performance-based work employs a variety of mediums, from participatory installations to

sculpture, painting, writing, theatre, video, and curation. Portnoy is largely concerned with manipulating language and behaviour as a tool for world-bending—either in his “Relational Stalinist” game structures, in which confusion, complication, and ambiguity are used to stretch participants’ speech and movement, or in his quest to “improve” existing breeds of art through re-engineering.

Portnoy has presented internationally in museums, art galleries, theatres, and music halls, including recently at Steirischer Herbst, Graz, 2018 and 2019; Witte de With, Rotterdam, 2016; Centre Pompidou, Paris, 2015; Stedelijk Museum Amsterdam, 2014; Cricoteka, Krakow, 2014; Palais de Tokyo, Paris, 2013; KW Institute for Contemporary Art, Berlin, 2013; The Kitchen, New York, 2013; dOCUMENTA (13), Kassel, Germany; 11th Baltic Triennial (co-curator), Vilnius, 2012; and Taipei Biennial, Taipei, 2010.

Silja Rantanen

Silja Rantanen (FI) was Guest Teacher at Malmö Art Academy in 2010–11 and 2018.

Rantanen belongs to the pioneers of postmodern conceptual painting in Finland. She represented Finland at the Venice Biennale in 1986. A retrospective exhibition of her art took place at Sara Hildén Art Museum, Tampere, and her latest solo show was held at Galerie Anhava, Helsinki. Additionally,

Rantanen has made numerous public artworks, including for the facade of the control tower at the Stockholm Arlanda Airport in 2001 and a facade decoration at Kvarteret Victoria in Helsinki in 2016–18 (together with Carolus Enckell).

In 2014, she obtained a Doctorate in Fine Arts from the Academy of Fine Arts, Helsinki, and between 2010 and 2015, Rantanen was Professor at the same academy. She has been an active participant in the cultural debate throughout her career as an artist. In her writings, she interprets art historical subjects as seen through the eyes of a contemporary artist, plus the relationship between visual art and other arts. Rantanen's published essays are on topics ranging from the films of Pedro Almodóvar, to the avant-garde art of Natalja Gontšarova, to the literature of Leo Tolstoy.

Rantanen has received the Nordic Art Prize of the Edstrand Art Foundation, Ars Fennica Award, Second Prize of the Carnegie Art Award, and Culture Prize of the Finnish-Swedish Cultural Foundation. She has also been awarded the decoration of Commander of the Order of the Lion of Finland and the Pro Finlandia Medal.

Hans Hamid Rasmussen

Hans Hamid Rasmussen (NO) was Guest Teacher at Malmö Art Academy in 1995.

Rasmussen is an artist based in Oslo. He studied at the Photo Academy at Konstfack—University of

Arts, Crafts and Design in Stockholm and the Academy of Fine Art in Oslo. He was Research Fellow in the National Norwegian Artistic Research Fellowships Programme at Trondheim Academy of Fine Art (2004–07), where he also participated in the doctoral programme with the project *Homage to a Hybrid*, supervised by the artist Nina Roos, philosopher and curator Sarat Maharaj, and curator Maaretta Jaukkuri. He currently holds a position as Professor in Visual Art and was until recently Head of Textile in the Art and Craft department at Oslo National Academy of the Arts (2008–20).

In the spring of 2016, Rasmussen gave a solo presentation for Martin Asbæk Gallery at MARKET Art Fair in Stockholm, and he has had solo exhibitions at Østfold Art Centre in Fredrikstad, Norway, 2017; Martin Asbæk Gallery, Copenhagen, 2018; and Shoot Gallery, Oslo 2020. He has participated in shows such as the São Paulo Biennial, 2004; Guangzhou Triennial, 2008; Göteborg International Biennial for Contemporary Art, 2011; Hangzhou Triennial of Fiber Art, 2016; and Havana Biennale, 2019.

Joakim Sandqvist

Joakim Sandqvist (SE) graduated with an MFA from Malmö Art Academy in 2018.

Sandqvist works in a wide variety of mediums. In recent years, he has been investigating the

shift from industrialism to post-industrialism that is taking place in the Global North, with a particular interest in the change and displacement of labour due to outsourcing and automation, and how this has changed the cultural idea of work. Focusing on the traces and indexes of production, Sandqvist backtracks images and objects, examining the confusion where images and objects seem to have erased their own footprints. He is also exploring the structure of the digital image and its inherent complex relation between realism and abstraction.

Marie Thams

Marie Thams (DK) was Editor of the *Malmö Art Academy Yearbook* from 2013 to 2019 and was Guest Teacher at Malmö Art Academy in 2015.

Thams is a visual artist based in Copenhagen. She holds an MFA from the Royal Danish Academy of Fine Arts, Schools of Visual Arts, Copenhagen (2011) and a BA(Hons) in Fine Arts and History of Art from Goldsmiths, University of London (2009). Her work reacts to current cultural and political structures and values, resulting in critical and sensuously enclosing works. Voice plays a key role in Thams's practice, which she works with in installation, audio works, performance, and publication.

Recent solo exhibitions include URBANEK, London; Milestone Institute, Budapest; c4 projects, Copenhagen; Viborg Kunsthall, Denmark (duo); and Holodeck, Oslo.

Recent group exhibitions include ARKEN Museum for Modern Art, Ishøj, Denmark; Heartland Festival, Egeskov Park, Denmark; I meter I, Copenhagen; Klink Studios, Barcelona; Galleri SPECTA, Copenhagen; Danske Grafikeres Hus, Copenhagen; Mellemfolkeligt Samvirke/ ActionAid, Copenhagen; fourFOLD, London; 700IS Reindeerland, Reykjavík; Overgaden Institute of Contemporary Art, Copenhagen; and Screen Festival, Barcelona. Thams's work can be found in the collection of the National Gallery of Denmark, Copenhagen.

Thams also works as independent organiser and editor, is a member of the Board of Representatives of the Danish Arts Foundation (2017–20), and in recent years has been a guest teacher at Bergen Academy of Art and Design; Royal Danish Academy of Fine Arts, Copenhagen; and Funen Art Academy, Odense, Denmark.

Current Faculty

Gertrud Sandqvist, Professor of Art Theory and the History of Ideas and Supervisor of the Doctoral Programme
Sarat Maharaj, Professor in Visual Art and Knowledge Systems and Supervisor of the Doctoral Programme
Joachim Koester, Professor of Fine Arts
Fredrik Værsløv, Professor of Fine Arts
Emily Wardill, Professor of Fine Arts
Maj Hasager, Vice Rector and Senior Lecturer in Fine Arts
Maria Hedlund, Senior Lecturer in Fine Arts
Per-Olof Persson, Senior Lecturer in Fine Arts
Youngjae Lih, Junior Lecturer in Fine Arts
Laura Hatfield, Junior Lecturer in Fine Arts
Rosa Barba, External Visiting Lecturer in Fine Arts
Charif Benhelima, External Visiting Lecturer in Fine Arts
Alejandro Cesarco, External Visiting Lecturer in Fine Arts
Matts Leiderstam, External Visiting Lecturer in Fine Arts and Researcher
João Penalva, External Visiting Lecturer in Fine Arts
Nina Roos, External Visiting Lecturer in Fine Arts
Christine Ödlund, External Visiting Lecturer in Fine Arts

Current PhD Candidates

Yael Bartana, Jürgen Bock, Bouchra Khalili, Lea Porsager, Pia Rönicke

Current Staff

Gertrud Sandqvist, Rector and Artistic Director
Silvana Hed, Director
Charlotta Österberg, Financial Officer
Evalena Tholin, Programme Administrator and Exhibition Coordinator
Madeleine Bergquist, Librarian
Ariel Alaniz, Technician (metal, wood, and sculpture workshops)
Kristian Nordström Kimbré, Technician (photography studio)
Sophie Ljungblom, Technician (moving images)
Mathias Kristersson, Technician (wood and sculpture workshops, KHM Galleries)
Joakim Sima, Technician (IT, sound studio)
Eva-Lena Landgren, Caretaker

Professors and Acting Professors over the years have included Matthew Buckingham, Jimmie Durham, Annika Eriksson, Andrea Geyer, Charlotte Gyllenhammar, Matts Leiderstam, Lars Nilsson, Sophie Tottie, Haegue Yang, Knut Åsdam¹

Lecturers over the years have included Annette Abrahamsson, Niels Bonde, Margot Edström, Jens Fänge, Viktor Kopp, Axel Lieber, Simon Sheikh, Magnus Wassborg

External Visiting Lecturers over the years have included Cecilia Edefalk, Annika Eriksson, Voebe de Gruyter, Sigurdur Gudmundsson, Olav Christopher Jenssen, Eva Löfdahl, Nathalie Melikian, Berend Strik, Claes Söderqvist

Guest Teachers over the years have included:

(organised by first year of teaching; many have taught in multiple years)

- 1995–96 Leif Alsheimer, Bill Arning, Ola Billgren, Daniel Birnbaum, Fransceso Bonami, Christine Borland, Robert Cassland, Olga Chermucueva, Clementine Deliss, Karen Eslee, Hans Ekelund, Daniel Frye, Mats Furberg, Bernard Gebert, Arnold Hagström, Salah M. Hassan, Madeleine Hatz, Noritoshi Hirakawa, Thomas Hopkins, Ronald Jones, Per-Anders Jörgensen, Mary Kelly, Ole Larsen, Peter Ragnarsson, Hans Hamid Rasmussen, Jason Rhoades, Martin Rogberg, Thomas Ruff, Nils-Eric Sahlin, Ralf Samens, Andres Serrano, Jim Shaw, Eva Schmidt, Ann-Sofi Sidén, Mats Stjernstedt, Luc Tuymans, Marianne Uutinen, Marika Wachtmeister, Marnie Weber, Magnus Welinder, Jeff Wiesniewski, Sam Taylor Wood
- 1996–97 Ina Blom, Niels Borch-Jensen, Richford Ekholm, Michel Francois, Voeve de Gruyter, BKH Gutmann, Jörgen Hansen, Måns Holst-Ekström, Fiona Jones, Dan Jönsson, Bernd Kastner, Rachel Khedoori, Mark Kremer, Tommy Lindholm, Alf Lundberg, Michel Majerus, Katrin von Matzahn, Aernout Mik, Mitsuko Miwa, Peter Sjöblom, David Skoog, Direk Skrebner, Abigail Solomon-Godeau, Lars Henric Ståhl, Al Taylor, Michael Wade, Lina Waelgaard
- 1997–98 Lex ter Braak, Lynne Cooke, Kristjån Gudmundsson, Arnold Hagström, Friedrich Meshede, Eva Meyer, Jan-Olov Nilsson, Paul Osipow, José Pacheco, Per Pålsson, Lars Ramberg, Liisa Roberts, Eran Schaerf, Lars-Henric Ståhl, Magnus Wallin, Dan Wolgers
- 1998–99 Joël Bartolomeo, Jeanette Christensen, Michael Elmgreen & Ingar Dragset, Sharon Lockhardt, Jérôme Sans, Alex Slade
- 1999–2000 Janine Antoni, Liesbet Bik, Rody Buchanan, Jaqueline Donachie, Jeanne Dunning, Mary Beth Edelson, Renée Green, Pål Hollender, Doug Ishar, Johannes Kahrs, Niclas Malmström, Åsa Nacking, Kent Olofsson, Jos van der Pol, Collier Schorr, Simon Starling, Jan Svenungsson, Magdolna Szabo, Marijke van Warmerdam
- 2000–01 Kjell Björn, Willie Doherty, Anders Kreuger, Dirk Snauwert, Shepherd Steiner
- 2001–02 Morgan Fisher, Sharon Hayes, Stefan Karlsson, Michael Levine, Torbjörn Limé, One Architects, Fredrik Strid, Bettina Camilla Vestergaard
- 2002–03 Ute Meta Bauer, Zarina Bhimji, Kim Borreby, Marion Bösen, Pavel Büchler, Zhiyuan Cui, Alec Finlay, Ronny Hansson, Stefan Jonsson, Juan Maidàgan, Friedrich Meschede, Lars T. Mikkelsen, Stephan Pascher, Nana Petzner, Annika Karlsson Rixon, Peter Robinson, Hale Tenger, Annika Vik, Dolores Zinny
- 2003–04 Dennis Adams, Jens Haaning, Mika Hannula, Lene Crone Jensen, Stefan Klaverdal, Rudi Laermans, Robert Moreau, Marion von Osten, Rajeswari Sunder Rajan, Gayatri Chakravorty Spivak, Shepherd Steiner, Hito Steyerl
- 2003–04 Zandra Ahl, Alexander Alberro, Lennart Alves, Julie Ault, Holger Nielsen Bech, Lennart Alves, Scott Bukatman, Barbara Clausen, Jakob Jakobsen, Simon Leung, Masato Kobayashi, Astrid Mania, Julie Martin, Simon Möller, Jun Nguyen-Hatsushiba, Johan Nobell, Nikos Papastergiadis, Yvonne Rainer, Gerald Running, Annika Ström, John Sundholm, Robert Whitman, Ola Wong, Florian Wüst
- 2005–06 Michael Blum, Anna Johansson, Emma Reichert, Henrik Skotte
- 2006–07 Jeuno JE Kim

- 2007–08 Torsten Andersson, Maria Bjurestam, Boris Buden, Yane Calovski, Jan Cardell, Kim Cascone, Ewa Einhorn, Luca Francesconi, Lars Olof Gustafsson, Helena Holmberg, Mathias Holmberg, Kahled Hourani, Zhang Jian, Jacob Kreuzfeldt, Christina Kubitsch, Kristina Lindström, Jan-Erik Lundström, Per Mårtensson, David Neuman, Bo Nilsson, Annika Öhrner, Rebecca H. Quaytman, Lisa Rosendahl, Torben Sangild, Eva Sjuve, Michael Snow, Rune Søchting, Åsa Ståhl, Liv Strand, Lynne Tillman, Dmitry Vilensky, Christian Vivant, Soyoung Yoon
- 2008–09 Karin Mamma Andersson, Catalin Gheorghe, Vincent Geyskens, Clay Ketter, Vjayanthi Pao, Amy Sillman, Astrid Svangren, David Svensson, Jan Verwoert, Sven Olof Wallenstein
- 2009–10 Geza Antal, Vaginal Davis, Henriette Huldich, Erik Granly Jensen, Ella Tillema, Viola Varhson
- 2010–11 Derek Holzer, Trond Lundemo, Jonas Olesen, Silja Rantanen
- 2011–12 Jeremiah Day, Michelle Eistrup, Marc Herbst, Frans Jacobi, Haraldur Jonsson, Mathias Kristersson, Lars Bang Larsen, Rikke Luther, Torbjörn Milneur, Tijana Mišković, Andrea Ray, Cecilia Wendt, What, How & for Whom/WHW
- 2012–13 Magnus Bårtås, David Cuartielles, Ann-Mari Edström, Beata Fransson, Maria Fusco, Linda Norden, Cecilia Widenheim
- 2013–14 Daniel Peder Askeland, Ioanamaría Cojocariu, Maria Draghiol, Katrine Hjelde, Anne Holmfred, David Krantz, Alanna Lockward, Ieva Misevičiūtė, Matilda Plöjel, Kristina Lee Podesva, Michael Portnoy, Simon Rees, Solfrid Söderlind
- 2014–15 Anna Bokström, Klara Kristalova, Neil Mulholland, David Nilsson
- 2015–16 Gulsen Bal, Dave Beech, Kirsty Bell, Martin Clark, Régine Dura, Jeannette Ehlers, Tiril Hasselknappe, Andy Hewitt, Georgia Holz, Susan Jahoda, Joan Jonas, Mel Jordan, Liz Kinoshita, Hans-Werner Koesinger, Lui Mokrzucki, Matthew Rana, Walter Seidl, Marie Thams, Caroline Woolard
- 2016–17 Cristina Gómez Barrio, Gert Biesta, Hans Carlsson, Laura Carr, Franco Farinelli, Chuva Featherstone, Ángela Ferreria, Paul Gilroy, Betty Govinden, Ulrik Heltoft, Andy Hewitt, Thomas Higham, Barbara Mahlke, Craig Martin, Lisa Nyberg, Josefin Snygg, Ulf Stålhane, Christina Wainikka
- 2017–18 Tim Bishop, Mikkel Bolt, Alfred Boman, Margit Brundin, Paul Fåggerskjöld, Atoosa Farahmand, Silvia Federici, Elisabeth Frieberg, Simryn Gill, Ulf Peter Hallberg, Hannah Jickling, Iris Johansson, Johanne Løgstrup, Diana Mulinari, Temi Odumoso, Johan Österholm, Gunilla Palmstierna-Weiss, Joseph del Pesco, Helen Reed, Sisters Academy, Tobias Sjöberg, Tim Smith, Fredrik Svensk, Ana María Bermeo Ujueta
- 2018–19 Katarina Renman Claesson, Katy Deepwell, Ramona Dima, Simona Dumitriu, Patrik Elgström, Niels Henriksen, Lina Issa, Maaïke Muntinga, Michala Norup, Kira Nova, Jonna Pettersson, Elizabeth Sweeney
- 2019–20 Margot Brundin, Lena Johansson, Tobias Linné, Stephan Møller

External Examiners,² most of whom have been internationally active curators, have included Felicity Allen, Roel Arkesteijn, Bart de Baere, Heidi Ballet, Kirsti Bell, Jürgen Bock, Oscar van den Boogaard, Iwona Blazwick, Carolyn Christov-Barkagiev, Martin Clark, Lynne Cooke, Abraham Cruzvillegas, Charles Esche, Rita Fabiana, Jens Fänge, Sabine Folie, Brigitte Franzen, Stine Hebert, Katrine Hjelde, Georgia Holz, Lolita Jablonskiené, Christina Kubisch, Marie Laurberg, Lisa Le Feuvre, Maria Lind, Barbara Mahlknecht, Matthias Michalka, Jessica Morgan, Marie Muracciole, Filipa Oliveira, Livia Paldi, Dirk Snauwert, Mats Stjernstedt, Robert Storr, Apolonija Šušteršič, Marianne Torp, Alexis Vaillant, Jochen Volz, Scott Watson, Cecilia Widenheim, Axel Wieder

Staff over the years has included Basam Albasim, Gert Andersson, Lars Andersson, Mattias Arvastsson, Anki Bengtsson, Eva Bertmark, Elisabeth Bonakdar Hashemi, Olof Broström, Isabell Dahlberg, Margot Edström, Karin Göransson, Elin Hasselberg, Mathias Jansson, Jeuno JE Kim, Henrik Lagergren, Kaj Larsson, Sarah Lundén, Charlotte Marklund, Annika Michelsen, Lars Gustav Midbøe, Ulf Nordström, Per Nordvi, Håkan Nyqvist, Gunilla Öhlin, Gunilla Ollerstam, Sven Yngve Oscarsson, Davor Peraic, Shirin Sabahi, Peter Sandegård, Dan Setthammar, Jenny Svensson, Teresa Tönisberg, Henrik Tuszyński, Magnus Welinder, Martin Widerberg.

1 Many were also Guest Teachers prior to their engagement as Professors or Acting Professors.

2 Several of External Examiners have also been Guest Teachers over the years.

Trust, a Core Condition
Malmö Art Academy 25 Years

Editors:
Maj Hasager
Matts Leiderstam
Marie Thams

Translator:
Jan Salomonsson
(Swedish to English):
Texts by
Matts Leiderstam
Silja Rantanen
Lars Nilsson

Copyeditor:
Jaclyn Arndt

Proofreader:
Francis Patrick Brady

Design:
Eller med a

Printer:
Danagård Litho

ISBN:
978-91-985592-4-8

Publisher:
Malmö Art Academy
Box 4035
SE-203 11 Malmö
www.khm.lu.se

Publishing Supervisor:
Silvana Hed

© 2020 Malmö Art Academy, the artists, authors, and photographers. All rights reserved. No part of the contents of this book may be reproduced, stored in retrieval system, or transmitted in any form or by any means, electronic, mechanical, photocopying, recording, or otherwise, without the written permission of the Malmö Art Academy



The absolute core condition for making an environment in which art can happen is trust.

If anything, this type of environment is in danger in our contemporary societies, at least for us as educators.

We must be able to trust our artist-students. We must be able to trust our artist-teachers. We must dare to allow individual curricula to have long periods when seemingly nothing is happening. We must learn how to listen to the breath of creativity.

We must facilitate this by allowing small unities, where people know each other and trust each other.

We must dare to describe rather than prescribe.

We must learn to recognise the signs that tell us when to act and when to wait.

We must be able to consider an art academy as an organism rather than a structure.

—Gertrud Sandqvist

Trust, a Core Condition: Malmö Art Academy 25 Years marks the twenty-fifth anniversary of Malmö Art Academy with twenty-five texts and artworks by:

Julie Ault

Ute Meta Bauer

Ola Billgren

Jürgen Bock

Sebastião Borges

Lynne Cooke

Kajsa Dahlberg

Övül Ö. Durmusoglu

Okwui Enwezor

Andrea Geyer

Karin Hald

Maj Hasager

Leif Holmstrand

Olav Christopher Jenssen

Mary Kelly

Mark Kremer

Anders Kreuger

Ellinor Lager

Matts Leiderstam

Sarat Maharaj

Åsa Nacking

Lars Nilsson

Max Ockborn

Joana Pereira

Michael Portnoy

Silja Rantanen

Hans Hamid Rasmussen

Joakim Sandqvist

